



skai® Contract Collection 1
Interior

Information

Empfohlene Einsatzgebiete
Technische Daten
Flammschutzübersicht
IMO-Übersicht
Nachhaltigkeitskriterien
Desinfektionsmittelempfehlung
Reinigung und Pflege

Information

Fields of application
Technical specifications
Flame retardant standards
IMO overview
Sustainability Scorecard
Disinfectant recommendation
Cleaning and care

Información

Campos de aplicación
Especificaciones técnicas
Certificaciones de ignifugación
IMO vista de conjunto
Criterios de sostenibilidad
Recomendaciones para desinfección
Limpieza y cuidado

Sustainability

	Made in
skai® Evida	GER
skai® Evida Fiber	GER
skai® VyP Coffee	GER

Leather Design FR

	Made in
skai® Parotega NF, skai® Palma NF	GER
skai® Pureto FAR	GER
skai® Sotega FLS	GER
skai® Pavinto	GER
skai® Plata	GER
skai® Mailo	ESP
skai® Palma	GER
skai® Gemini	ESP
skai® Gavino	ESP

Textile Design

	Made in
skai® Totexo EN	GER
skai® Paratexa NF	GER
skai® Torino FLS	GER
skai® Pandoria Plus	GER
skai® Makari	ESP
skai® Galeno	ESP



Information / Information / Información

Empfohlene Einsatzgebiete
Technische Daten
Flammschutzübersicht
IMO-Übersicht
Nachhaltigkeitskriterien
Desinfektionsmittelempfehlung
Reinigung und Pflege

Fields of application
Technical specifications
Flame retardant standards
IMO overview
Sustainability Scorecard
Disinfectant recommendation
Cleaning and care

Campos de aplicación
Especificaciones técnicas
Certificaciones de ignifugación
IMO vista de conjunto
Criterios de sostenibilidad
Recomendaciones para desinfección
Limpieza y cuidado

skai® Contract Collection 1

Empfohlene Einsatzgebiete / Fields of applications / Ámbitos de aplicación recomendados

Register Register Registro	Artikel Article Artículo	 Public Area	 Hospitality	 Residential	 Healthcare	 Aviation	 Fitness
Sustainability	skai® Evida	●	●	●	●		
	skai® Evida Fiber	●	●	●	●		
	skai® VyP Coffee	●	●	●			
Leather Design FR	skai® Parotega NF	●	●	●	●		●
	skai® Palma NF	●	●	●	●		●
	skai® Pureto FAR	●	●	●		●	
	skai® Sotega FLS	●	●	●			
	skai® Pavinto	●	●	●			●
	skai® Plata	●	●	●	●		●
	skai® Mailo	●	●	●	●		
	skai® Palma	●	●	●	●		
	skai® Gemini	●	●	●	●		●
	skai® Gavino	●	●	●	●		●
	Textile Design	skai® Totexo EN	●	●	●		
skai® Paratexa NF		●	●	●	●		
skai® Torino FLS		●	●	●			
skai® Pandoria Plus		●	●	●	●		●
skai® Makari		●	●	●	●		
skai® Galeno		●	●	●	●		



skai® Contract Collection 1

Technische Daten / Technical specifications / Datos técnicos

Register Register Registro	Artikel Article Artículo	Gewicht Weight Peso	Dicke Thickness Espesor	Martindale (DIN EN ISO 5470-2) Abrieb invers Abrasion inverse Abrasión inverso	Abrieb (Wyzenbeek) Abrasion (Wyzenbeek) Abrasión (Wyzenbeek)	Warenbreite Roll width Ancho de rollo	Rollenlänge Length of roll Largo de rollo	Schwer entflammbar Flame retardant Retardante de llama	phthalatfrei phthalate-free no contiene ftalatos	lösemittelfreies Finish solvent-free finish exento de solvente
Sustainability	skai® Evida	750 +/- 50 g/m ²	1.05 +/- 0.2 mm	100 000		137 cm	30m	●	●	
	skai® Evida Fiber	750 +/- 50 g/m ²	1.05 +/- 0.2 mm	100 000		137 cm	30m	●	●	
	skai® VyP Coffee	690 +/- 50 g/m ²	1.4 +/- 0.2 mm	100 000		140 cm	30m	●	●	●
Leather Design FR	skai® Parotega NF	780 +/- 50 g/m ²	1.25 +/- 0.2 mm	300 000		137 cm	30m	●		
	skai® Palma NF	780 +/- 50 g/m ²	1.2 +/- 0.2 mm	300 000		137 cm	30m	●		
	skai® Pureto FAR	570 +/- 50 g/m ²	1.0 +/- 0.2 mm	100 000*		140 cm	30m	●	●	●
	skai® Sotega FLS	740 +/- 50 g/m ²	1.6 +/- 0.2 mm	200 000		150 cm	30m	●		●
	skai® Pavinto	800 +/- 50 g/m ²	1.4 +/- 0.2 mm	150 000	100 000	137 cm	30m	●		
	skai® Plata	800 +/- 50 g/m ²	1.4 +/- 0.2 mm	100 000		137 cm	30m	●		
	skai® Maillo	825 +/- 65 g/m ²	1.3 +/- 0.2 mm	80 000		140 cm	30m	●		●
	skai® Palma	800 +/- 50 g/m ²	1.35 +/- 0.2 mm	100 000		137 cm	30m	●		
	skai® Gemini	655 +/- 85 g/m ²	1.1 +/- 0.2 mm	300 000*		140 cm	30m	●		●
	skai® Gavino	735 +/- 65 g/m ²	1.2 +/- 0.2 mm	160 000		140 cm	30m	●		●
	Textile Design	skai® Totexo EN	740 +/- 50 g/m ²	1.1 +/- 0.2 mm	50 000		140 cm	30m	●	●
skai® Paratexa NF		780 +/- 50 g/m ²	1.35 +/- 0.2 mm	100 000	100 000	137 cm	30m	●		
skai® Torino FLS		790 +/- 50 g/m ²	1.3 +/- 0.2 mm	150 000	100 000	140 cm	30m	●	●	●
skai® Pandoria Plus		800 +/- 50 g/m ²	1.3 +/- 0.2 mm	300 000		140 cm	25m	●		
skai® Makari		800 +/- 60 g/m ²	1.3 +/- 0.2 mm	150 000		140 cm	30m	●		●
skai® Galeno		820 +/- 80 g/m ²	1.1 +/- 0.2 mm	125 000		140 cm	30m	●	●	●

*DIN EN ISO 5470-1



skai® Contract Collection 1

Flammschutzübersicht / Flame retardants standards / Certificaciones de resistencia al fuego



	Norm Norme	DIN EN 1021 -1/ -2	BS 5852 IS O+1	IMO FTPC 2010 Part 8	ÖNORM B 3825	ÖNORM A 3800-1	BS 5852 IS-5+7	UNI 9175:2010	DIN 4102-1	NF P 92-503	NF D 60-013 (Article AM 18)	UNE 23 727-90	DIN 66084	EN 15102 / DIN EN 13501-1	MVSS 302	ECE R118 Annex 6, 7	ECE R118 Annex 8	FAR 25.853 Part I (a)(1)(ii)	CA TB 117-2013 Section 1	UFAC Method 1990 / NFPA 260-19	ASTM E 84
	Klassifizierung Class Classe	Pass	Pass	Pass	schwer brennbar	Q1	Crib V, VII Pass	1.IM	B1, B2	M1, M2	Pass	M2	P-a	B-s3, d0		Pass	Pass	Pass	Cigarette Pass	Cigarette Pass	„Tunnel test“ Class A, Class B
Register Register Registro	Artikel Article Articulo																				
Sustainability	skai® Evida	●	●	●															●	●	
	skai® Evida Fiber	●	●	●															●	●	
	skai® VyP Coffee	●	●	●											●				●	●	
Leather Design FR	skai® Parotega NF	●	●	●	●	●	Crib V, VII	●	B1, B2	M1	●		●	●	●			●	●	●	Class A
	skai® Palma NF	●	●	●	●	●	Crib V, VII	●	B1, B2	M1	●		●	●	●			●	●	●	Class A
	skai® Pureto FAR	●	●	●											●			●	●	●	
	skai® Sotega FLS	●	●	●			Crib V	●	B2	M2					●				●	●	Class A
	skai® Pavinto	●	●	●					B2	M2					●				●	●	
	skai® Plata	●	●	●				●	B2	M2					●	●	●	●	●	●	
	skai® Mailo	●		●			Crib V		B2			●									
	skai® Palma	●	●	●				●	B2	M2					●	●	●	●	●	●	
	skai® Gemini	●		●					B2	M2						●			●		
	skai® Gavino	●		●			Crib V		B2			●									
Textile Design	skai® Totexo EN	●	●	●											●						
	skai® Paratexa NF	●	●	●	●	●	Crib V	●	B1, B2	M1	●			●	●				●	●	
	skai® Torino FLS	●	●	●	●	●	Crib V	●	B2	M2	●				●			●	●	●	
	skai® Pandoria Plus	●	●	●				●	B2	M2					●			●			
	skai® Makari	●		●			Crib V		B2			●									
	skai® Galeno	●		●			Crib V	●	B2		●	●						●	●		



© Ingrid Febak Fotografie

skai® Cruise Ship Products
Contract Collection 1

Impressionen / Impressions / Impresiones



Schiffe / Ships / Barcos

Carnival Vista
 Carnival Horizon
 Costa Favolosa
 Costa Fortuna
 Costa Magica
 Cunard Queen Elizabeth
 Cunard Line Queen Mary II
 Disney Dream
 Disney Fantasy
 Genting Dream
 Marella Explorer 2
 MSC Preziosa
 MSC Poesia
 MSC Seaview
 MSC Sinfonia
 MSC Armonia

MSC Fantasia
 MSC Rhapsody
 MSC Meraviglia
 Norwegian Bliss
 Norwegian Breakaway
 Norwegian Getaway
 Norwegian Escape
 Norwegian Joy
 P&O Cruises Britannia
 P&O Cruises Pacific Explorer
 P&O Orania
 Ponant Le Champlain
 Ponant Le Lapérouse
 Royal Caribbean Oasis of the Sea
 Royal Caribbean Quantum of the Seas
 Royal Caribbean Anthem of the Seas

Royal Caribbean Ovation of the Seas
 Royal Caribbean Symphony of the Seas
 Saga Spirit of Adventure
 Saga Spirit of Discovery
 Silversea Silver Muse
 Silversea Silver Cloud
 Silversea Silver Galapagos
 Silversea Silver Shadow
 Silversea Silver Spirit
 TUI Mein Schiff 3
 TUI Mein Schiff 4
 TUI Mein Schiff 5
 Viking Orion
 Viking Sun

IMO FTPC P8



Register Register Registro	Artikel Article Artículo		IMO FTPC 2010 Part 8	
		0161/2023		
Sustainability	skai® Evida	●	●	
	skai® Evida Fiber	●	●	
	skai® VyP Coffee	●	●	
Leather Design FR	skai® Parotega NF	●	●	
	skai® Palma NF	●	●	
	skai® Sotega FLS	●	●	
	skai® Pavinto	●	●	
	skai® Plata	●	●	
	skai® Mailo		●	
	skai® Palma	●	●	
	skai® Gemini		●	
	skai® Gavino		●	
	Textile Design	skai® Totexo EN		●
		skai® Paratexa NF	●	●
skai® Torino FLS		●	●	
skai® Pandoria Plus		●	●	
skai® Makari			●	
skai® Galeno			●	

Conformity: 0161 = Notified body number.

Alle Artikel, welche aktuell nicht in schwer entflammbarer Ausrüstung angeboten werden, können mit einer Mindestmenge von 700 lfm in IMO-Version gefertigt werden.

All articles that are currently not available in flameresistant equipment, can be produced in a minimum of 700 rm in IMO-version.

Todos los artículos que no se ofrecen actualmente como equipos ignífugos, se pueden fabricar en una cantidad mínima de 700 m/lineales, en la versión IMO.

Continental 
The Future in Motion

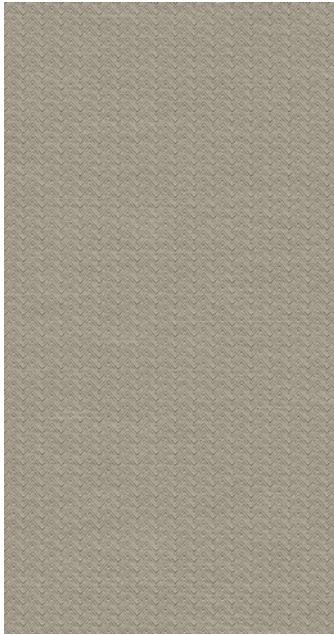

skai® Nachhaltigkeitskriterien

So nachhaltig sind die skai® Polsterbezugsstoffe

skai® Sustainability Scorecard

This is why the skai® upholstery fabrics are sustainable

Contract Collection 01





Nachhaltigkeitskriterien

So nachhaltig sind die skai® Polsterbezugstoffe
(07/2023)



Sustainability Scorecard

This is why the skai® upholstery fabrics are sustainable
(07/2023)

	Contract Collection 01	Sustainability			Leather Design FR										Textile Design							
	Artikel Article	skai® Evida	skai® Evida Fiber	skai® VyP Coffee	skai® Parotega NF	skai® Palma NF	skai® Pureto FAR	skai® Sotega FLS	skai® Pavinto	skai® Plata	skai® Mailo	skai® Palma	skai® Gemini	skai® Gavino	skai® Totexo EN	skai® Paratexa NF	skai® Topana FLS	skai® Torino FLS	skai® Pandoria Plus	skai® Palena	skai® Makari	skai® Galeno
Inhaltsstoffe Contents	Phthalatfrei Phthalate-free	●	●	●			●	●							●		●	●				●
	Einsatz nachwachsender Rohstoffe Use of renewable raw materials	●	●	●	●	●		●			●			●	●	●	●	●				
	Einsatz von Weichmachern auf Basis nachwachsender Rohstoffe Use of plasticizers based on renewable raw materials	●	●	●				●							●		●	●				
	Einsatz von Bio-Baumwolle oder recycelten PES-Fasern Use of organic cotton or recycled PES fibers	●	●	●											●							
	Lösemittelfreies Finish Solvent-free finish			●			●	●			●		●	●				●	●			●
Einsatz mineralischer Füllstoffe & Flammschutzmittel Use of mineral fillers & flame retardants	●	●												●								
Prozess Process	100% CO ₂ -neutraler Strom 100% CO ₂ -neutral electricity	●	●	●	●	●	●	●	●	●	●	●	●	●	●	●	●	●	●	●	●	●
	Reduzierter Energieeinsatz im Prozess Reduced energy usage in the process			●			●															
	Fertigstellung / Produktion an einem Standort Completion/production at one location	●	●	●	●	●	●	●	●	●	●	●	●	●	●	●	●	●	●	●	●	●
	In-House-Recycling In-house recycling	●	●	●	●	●	●	●	●	●	●	●	●	●	●	●	●	●	●	●	●	●
	Einsatz lokaler (DE) / regionaler (EU) Rohstoffe Use of local (GER) / regional (EU) raw materials	●	●	●	●	●	●	●	●	●	●	●	●	●	●	●	●	●	●	●	●	●
Eigenschaften Properties	Langlebigkeit Durability	●	●	●	●	●	●	●	●	●	●	●	●	●	●	●	●	●	●	●	●	●
	Ökotex-Zertifizierung Ökotex certification	●	●																			
	Medizinproduktegesetz / Biokompatibilität Medical Devices Act / Biocompatibility	●	●																●			
	PAK-Freiheit entsprechend der GS-Vorgaben Absence of PAH in accordance with GS specifications	●	●	●	●	●	●	●	●	●	●	●	●	●	●	●	●	●	●	●	●	●
	Spielzeugnorm EN 71-3 Toy standard EN 71-3	●																				
	Emission / CE-Konformität nach Baurecht Emission / CE conformity according to building law				●	●										●						

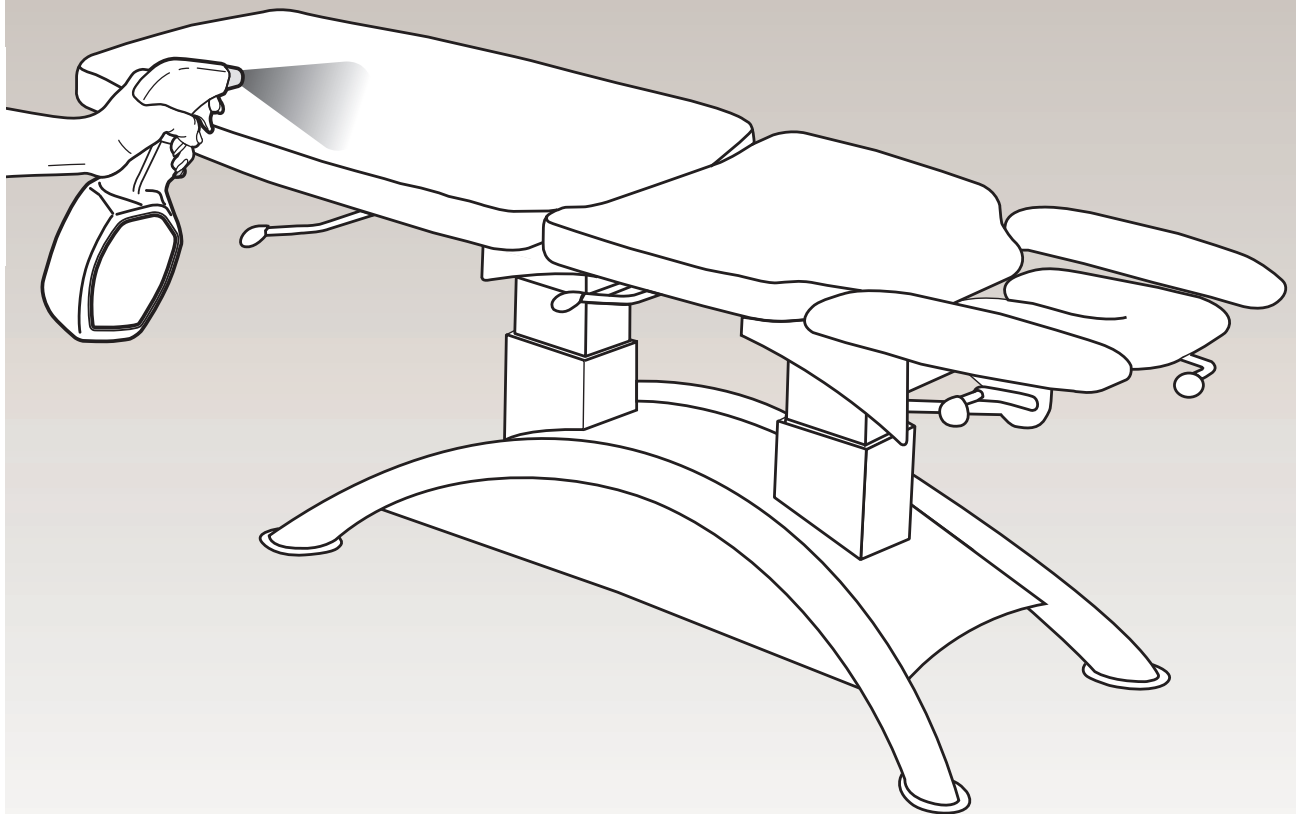

skai[®] Desinfektionsmittelempfehlung

skai[®] Disinfectant recommendation

skai[®] Recomendación de desinfectantes

Effectiveness
against
SARS-CoV-2



Desinfektionsmittelempfehlung

Hersteller Manufacturer Fabricante	Desinfektionsmittel Disinfectant Desinfectante	Dr. Schumacher GmbH							Bode Chemie GmbH				Schülke & Mayr GmbH				Ecolab GmbH				B. Braun Melsungen AG		Dürr Dental AG		Antiseptica Dr. H.-J. Mollitor GmbH		Lysoform Dr. Hans Rosemann GmbH		Tana Chemie GmbH	Aquaenius Schweiz GmbH	Cosimed GmbH					
		Cleanisept / Wipes	Optisept	Biguanid Fläche NR	Descosept PUP Wipes RTU	Descosept Sensitive Wipes	Descosept spezial Wipes	Ultrazol active	Mikrobac forte	Kohrsolin FF	Bacillo® 30 Sensitive	Dismozon plus	Perform	Mikrozid sensitive liquid	Mikrozid universal liquid	Terralin protect	Incidin liquid	Incidin Pro	Incidin Plus	Incidin Active	Incidin OxyWipe 5	Meiseptol foam pure	Meiseptol rapid	FD300	FD366	Biguacid S	Descogen Liquid r.f.u.	Lysoformin spezial	Aldasan 2000	Apesin rapid	Aquaama® Indigo®	Cosimed Konzentrat				
F641-	skai® Palma	●	●	●	●	●	●	●	●	●	●	●	●	●	●	●	●	●	●	●	●	●	●	●	●	●	●	●	●	●	●	●	●	●		
	skai® Plata	●	●	●	●	●	●	●	●	●	●	●	●	●	●	●	●	●	●	●	●	●	●	●	●	●	●	●	●	●	●	●	●	●		
	skai® Palma NF	●	●	●	●	●	●	●	●	●	●	●	●	●	●	●	●	●	●	●	●	●	●	●	●	●	●	●	●	●	●	●	●	●		
	skai® Pandoria Plus	●	●	●	●	●	●	●	●	●	●	●	●	●	●	●	●	●	●	●	●	●	●	●	●	●	●	●	●	●	●	●	●	●		
	skai® Pavinto	●	●	●	●	●	●	●	●	●	●	●	●	●	●	●	●	●	●	●	●	●	●	●	●	●	●	●	●	●	●	●	●	●	●	
	skai® Paratexa NF	●	●	●	●	●	●	●	●	●	●	●	●	●	●	●	●	●	●	●	●	●	●	●	●	●	●	●	●	●	●	●	●	●	●	
skai® dp Pandoria Plus base	●			●																●								●								
F642-	skai® Gavino				●		●												●	●							●									
	skai® Makari				●		●												●	●	●						●	●								
	skai® Marea				●		●												●	●	●						●	●								
	skai® Gemini				●		●								●	●				●	●						●	●								
	skai® Mailo				●		●								●	●				●	●						●	●								
skai® Galeno				●		●								●	●				●	●						●	●									
F646-	skai® Parotega NF	●	●	●	●	●	●	●	●	●	●	●	●	●	●	●	●	●	●	●	●	●	●	●	●	●	●	●	●	●	●	●	●	●		
	skai® Palena	●	●	●	●	●	●	●	●	●	●	●	●	●	●	●	●	●	●	●	●	●	●	●	●	●	●	●	●	●	●	●	●	●	●	
	skai® Tundra	●	●	●	●	●	●	●	●	●	●	●	●	●	●	●	●	●	●	●	●	●	●	●	●	●	●	●	●	●	●	●	●	●	●	
F647-	skai® Toledo EN	●	●	●	●	●	●	●	●	●	●	●	●	●	●	●	●	●	●	●	●	●	●	●	●	●	●	●	●	●	●	●	●	●	●	
	skai® Toronto EN	●	●	●	●	●	●	●	●	●	●	●	●	●	●	●	●	●	●	●	●	●	●	●	●	●	●	●	●	●	●	●	●	●	●	
	skai® Tovel EN	●	●	●	●	●	●	●	●	●	●	●	●	●	●	●	●	●	●	●	●	●	●	●	●	●	●	●	●	●	●	●	●	●	●	
	skai® Topana FLS, skai® Torino FLS	●	●	●	●	●	●	●	●	●	●	●	●	●	●	●	●	●	●	●	●	●	●	●	●	●	●	●	●	●	●	●	●	●	●	
skai® dp Toledo EN base	●				●															●																
F649-	skai® Neptun	●	●	●	●	●	●	●	●	●	●	●	●	●	●	●	●	●	●	●	●	●	●	●	●	●	●	●	●	●	●	●	●	●		
	skai® cool colors Venezia	●	●	●	●	●	●	●	●	●	●	●	●	●	●	●	●	●	●	●	●	●	●	●	●	●	●	●	●	●	●	●	●	●	●	
F680-	skai® Evida	●	●	●	●	●	●	●	●	●	●	●	●	●	●	●	●	●	●	●	●	●	●	●	●	●	●	●	●	●	●	●	●	●	●	
F507-	skai® Sotega	●	●	●	●	●	●	●	●	●	●	●	●	●	●	●	●	●	●	●	●	●	●	●	●	●	●	●	●	●	●	●	●	●	●	
	skai® Sotega Fls	●	●	●	●	●	●	●	●	●	●	●	●	●	●	●	●	●	●	●	●	●	●	●	●	●	●	●	●	●	●	●	●	●	●	
F761-	skai® Pureto EN	●	●	●	●	●	●	●	●	●	●	●	●	●	●	●	●	●	●	●	●	●	●	●	●	●	●	●	●	●	●	●	●	●	●	
VAH-Listung Stand 01/2019 VAH list as at 01/2019 Lista VAH, versión 01/2019		✓	✓	✓	✓	✓	✓	✓	✓	✓	✓	✓	✓	✓	✓	✓	✓	✓	✓	✓	✓	✓	✓	✓	✓	✓	✓	✓	✓	✓	✓	✓	✓	✓	✓	
RKI-Listung Stand 10/2017 RKI list as at 10/2017 Lista RKI, versión 10/2017			✓						✓	✓			✓				✓	✓									✓	✓								
Wirksam gegen SARS-CoV-2* Effective against SARS-CoV-2* Medidas efectivas contra el SARS-CoV-2*		✓	✓	✓	✓	✓	✓	✓	✓	✓	✓	✓	✓	✓	✓	✓	✓	✓	✓	✓	✓	✓	✓	✓	✓	✓	✓	✓	✓	✓	✓	✓	✓	✓	✓	✓

Die nebenstehende Matrix zeigt, welche Desinfektionsmittel zur Flächen-desinfektion von skai® Polstermaterialien empfehlenswert, bedingt empfehlenswert oder nicht zu empfehlen sind. Diese Einstufungen beruhen auf Erkenntnisse aus einer umfangreichen Testreihe mit den aufgeführten Materialien.

- Desinfektionsmittel, die zur Flächen-desinfektion von skai® Polstermaterial empfohlen werden.
- Desinfektionsmittel, die zur Flächen-desinfektion von skai® Polstermaterialien bedingt empfohlen werden. So gekennzeichnete Desinfektionsmittel bitte vor dem großflächigen Einsatz an einer verdeckten Stelle prüfen. Falls möglich verdünnt anwenden und nicht über einen längeren Zeitraum einwirken lassen.
- Desinfektionsmittel, die zur Flächen-desinfektion von skai® Polstermaterialien nicht zu empfehlen sind.

Anmerkung: Die Zusammensetzung der Desinfektionsmittel entspricht dem Stand zum Zeitpunkt der durchgeführten Prüfung. Für etwaige Änderungen an der Formulierung der Desinfektionsmittel durch die Hersteller kann seitens der Konrad Hornsusch AG keine Gewähr übernommen werden.

* Laut Herstellerangabe wirksam gegen SARS-CoV-2

Einwirkzeit / Verwendung entsprechend der Herstellerangaben auf dem Produkt.

The adjoining matrix shows which disinfectants are recommended, conditionally recommended or not recommended for disinfecting skai® upholstery materials. These classifications are based on the results of an extensive series of tests on the listed materials.

- Disinfectants recommended for disinfecting skai® upholstery material.
- Disinfectants which are only conditionally recommended for disinfecting skai® upholstery material. Disinfectants marked as such should be tested beforehand on a hidden section of the material. If possible, use diluted and do not allow them to act for a prolonged period.
- Disinfectants not recommended for disinfecting skai® upholstery material.

Note: The composition of the disinfectants corresponds to the status at the time of the test performed. Konrad Hornsusch AG cannot be held responsible for any changes in the formulation of disinfectants by the manufacturer.

* According to manufacturer's specifications, effective against SARS-CoV-2

Reaction time/use in accordance with manufacturer's instructions on the product.

La matriz que se muestra al lado indica qué desinfectantes son recomendables, relativamente recomendables o no recomendables para la desinfección de las superficies de los materiales de tapizado de skai®. Estas calificaciones se basan en las conclusiones de una amplia serie de pruebas realizadas con los materiales enumerados.

- Desinfectantes recomendados para la desinfección de las superficies de los materiales de tapizado de skai®.
- Desinfectantes condicionalmente recomendados para la desinfección de las superficies de los materiales de tapizado de skai®. Por favor, aplique los desinfectantes con dicha calificación en una zona no visible antes de aplicarlos en un área grande. Si es posible, aplíquelos rebajados con agua y no los deje actuar demasiado tiempo.
- Desinfectantes no recomendados para la desinfección de las superficies de los materiales de tapizado de skai®.

Observación: La composición de los desinfectantes corresponde al estado en el momento de la prueba realizada. Konrad Hornsusch AG no se hace responsable de ningún cambio en la formulación de los desinfectantes por parte de los fabricantes.

* Medidas efectivas contra el SARS-CoV-2 según el fabricante

Tiempo de exposición/uso según las instrucciones del fabricante del producto.

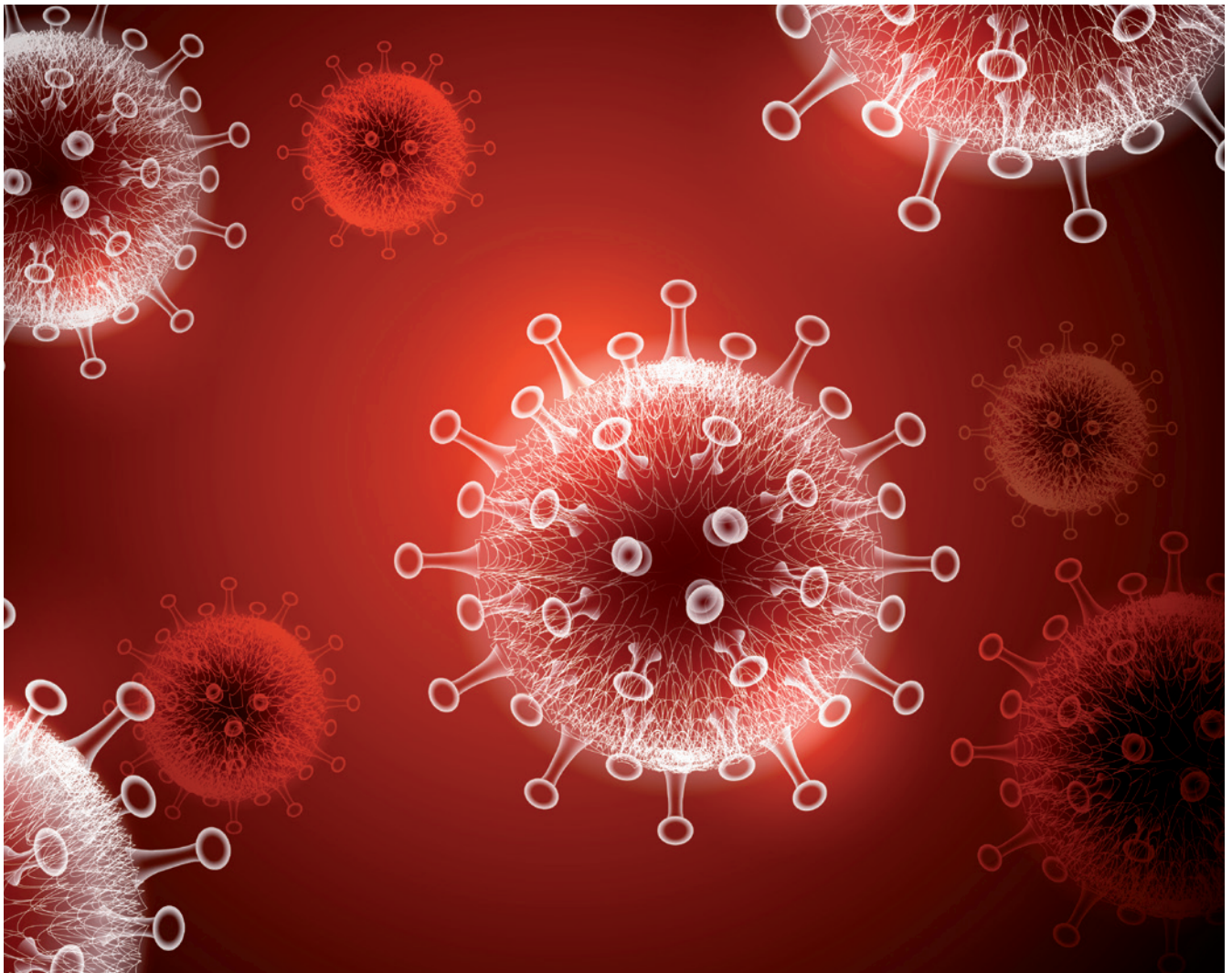

Reinigung und Pflege skai® Polster- und Modematerialien

Zum Erhalt der Materialeigenschaften Ihres skai® Produktes ist eine regelmäßige Reinigung der Materialoberfläche erforderlich. Benutzen Sie hierzu eine warme, milde Seifenlauge und ein Mikrofasertuch. Bei stärkeren Verschmutzungen kann auch eine weiche Handbürste verwendet werden.

Verschmutzungen durch Öle, Fette, stark färbende Lebensmittel oder andere Substanzen müssen umgehend entfernt werden. Der Reinigungsvorgang muss bei starken Verunreinigungen unter Umständen wiederholt werden. Bitte berücksichtigen Sie bei der Verwendung von handelsüblichen Tensid-Reinigern stets die Dosierungsanleitung des jeweiligen Herstellers.

Eine regelmäßige Reinigung Ihres skai® Produktes ist zum Erhalt der Lebensdauer ausreichend. Eine zusätzliche Behandlung z.B. mit Lederpflegemitteln ist nicht erforderlich.

Bitte verwenden Sie keine chemischen Bleichen oder scheuernde Reinigungsmittel.

Bitte beachten Sie, dass Anfärbungen des Materials durch Jeans oder andere Textilien von jeglicher Gewährleistung ausgenommen sind.

Cleaning and care skai® upholstery and fashion materials

To maintain the material properties of your skai® product, it is necessary to regularly clean the material surface. Use a warm, mild soap solution and a microfiber cloth for this purpose. A soft hand brush can also be used for heavier soiling.

Soiling due to oils, greases, highly-staining foods or other substances must be removed immediately. The cleaning process may have to be repeated in the event of heavy soiling. Please always observe the relevant manufacturer's dosage instructions when using commercially available surfactant cleaning agents.

Regular cleaning of your skai® product is sufficient to maintain its service life. No additional treatment, for example using leathercare products, is necessary. Please do not use any chemical bleaches or abrasive cleaning agents.

Please note that staining of the material through jeans or other textiles is excluded from any warranty.

Limpieza y cuidado de los materiales de tapizado y de moda de skai®

Para conservar las propiedades del material de su producto de skai® es necesario limpiar regularmente la superficie del material. Para ello, utilice lejía jabonosa caliente y suave y un paño de microfibra. Para la suciedad más incrustada también puede utilizarse un cepillo de mano suave.

La suciedad causada por aceites, grasas, alimentos u otras sustancias de fuerte coloración debe eliminarse inmediatamente. Es posible que haya que repetir el proceso de limpieza en caso de que exista suciedad severa. Siga siempre las instrucciones de dosificación del fabricante cuando utilice limpiadores con surfactantes convencionales.

La limpieza regular de su producto de skai® es suficiente para mantener la vida útil. No es necesario un tratamiento adicional, por ejemplo, con productos para el cuidado del cuero. No utilice blanqueadores químicos ni productos de limpieza abrasivos.

Tenga en cuenta que las manchas por decoloración en el material causadas por pantalones vaqueros u otros tejidos quedan excluidas de cualquier garantía.



Sustainability

Continental 
The Future in Motion

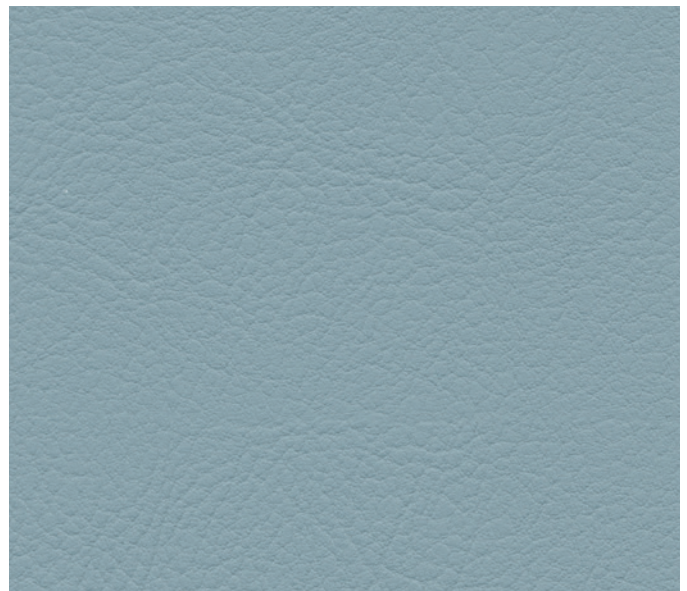

skai[®] Evida
Innovation

80%
natural and
renewable raw
materials



Die Oberfläche von skai® Evida überzeugt mit variantenreicher Ledernarbe und schmeichelnder Haptik. Das universell einsetzbare Bio-Kunstleder weiß aber vor allem mit inneren Werten nachhaltig zu punkten: skai® Evida besteht zu 80% aus natürlichen und nachwachsenden Rohstoffen.

The surface of skai® Evida impresses thanks to its richly varied leather grain and pleasant feel. This extremely versatile bio-based artificial leather scores points in particular with its inner values: skai® Evida is made from 80% natural and renewable raw materials.

La superficie de skai® Evida convence por su variado grano de cuero y su tacto agradable. La piel sintética ecológica de uso universal, sin embargo, es sostenible sobre todo por sus valores internos, ya que skai® Evida se compone en un 80 % de materias primas naturales y renovables.



skai® Evida dark moss F6800078

New

skai® Evida

white F6800021	cream F6800022	birch F6800041	smoke F6800042
lightgrey F6800030	concrete F6800073 New	cinder F6800074 New	olivebrown F6800075 New
stone blue F6800076 New	royal F6800025	anthracite F6800031	black F6800032
sage F6800077 New	dark moss F6800078 New	reed F6800079 New	olivegreen F6800080 New
rosé F6800081 New	marsala F6800082 New	merlot F6800083 New	gobi F6800084 New

Keine Urmuster hinsichtlich Farbe und Qualität. No counter samples regarding to colour and quality. No constituye una muestra de referencia en cuanto a color y calidad.

skai® Evida

fire F6800028	mango F6800085 New	atoll F6800024	lime F6800027

skai® Evida verringert den ökologischen Fußabdruck
 > Eingesetzte Komponenten bestehen zu mehr als 80% aus natürlichen und nachwachsenden Rohstoffen
 > Phthalatfreier Weichmacher auf Basis nachwachsender Rohstoffe
 > Produktion und Fertigstellung in Deutschland
 > Einsatz lokaler und regionaler Rohstoffe (EU)
 > 100% CO₂-neutraler Energie-Einsatz im Herstellungsprozess auf Basis erneuerbarer Energiequellen

skai® Evida Reduces Ecological Footprint
 > Components used are made from more than 80% natural and renewable raw materials
 > Use of phthalate-free plasticizers based on renewable raw materials
 > Produced and finished in Germany
 > Use of local and regional raw materials (EU)
 > Use of 100% CO₂-neutral energy in the manufacturing process based on renewable energy sources

skai® Evida reduce la huella ecológica
 > Más del 80% de los componentes utilizados son materias primas naturales y renovables
 > Plastificantes sin ftalatos basados en materias primas renovables
 > Producción y acabado en Alemania
 > Utilización de materias primas locales y regionales (UE)
 > Energía neutra con 100% del CO₂ utilizado en el proceso de fabricación basado en fuentes de energía renovables

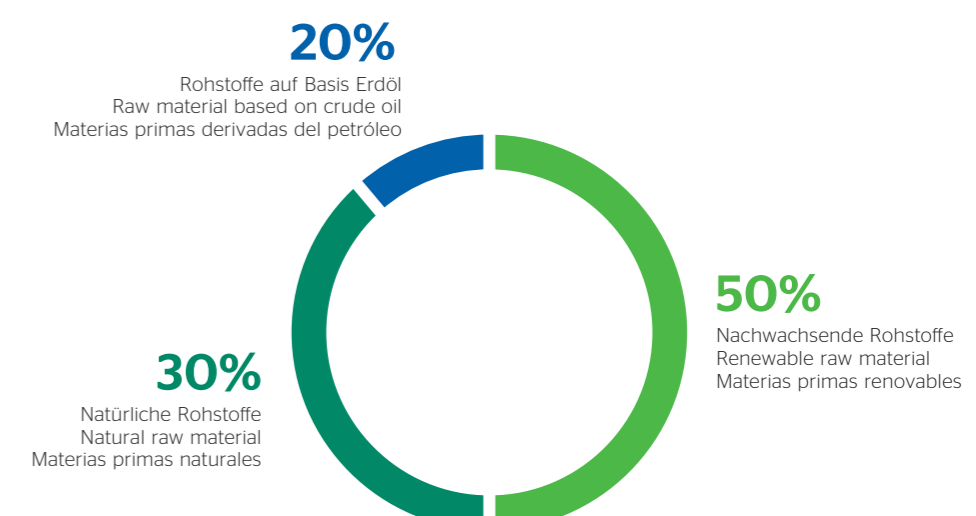



Public Area



Hospitality



Residential



Healthcare

Materialzusammensetzung:

ca. 50% nachwachsende Rohstoffe
ca. 30% natürliche Rohstoffe
ca. 20% erdölbasierende Rohstoffe

Gewicht: 750 +/- 50 g/m²

Dicke: 1,3 +/- 0,2 mm

Rollenbreite: 137 cm

Rollenlänge: 30m

Material composition:

approx. 50% renewable raw materials
approx. 30% natural based raw materials
approx. 20% raw materials based on crude oil

Weight: 750 +/- 50 g/m²

33.1 +/- 2.2 oz/yd

Thickness: 1.3 +/- 0.2 mm

Roll width: 137cm / 54 in

Roll length: 30m / 32.8 yd

Composición del material:

aprox. 50% de materias primas renovables
aprox. 30% de materias primas naturales
aprox. 20% de materias primas derivadas del petróleo

Peso: 750 +/- 50 g/m²

Espesor: 1,3 +/- 0,2 mm

Ancho de rollo: 137 cm

Largo de rollo: 30m



erfüllt Öko-Tex Standard 100
fulfills Öko-Tex Standard 100
Cumple la norma Öko-Tex 100



umweltfreundlich
environmentally friendly
ecológico



erfüllt Spielzeugnorm
fulfills toys norm
Cumple la norma para juguetes
DIN EN 71-3



abriebfest
abrasion resistant
resistencia a la abrasión
DIN EN ISO 5470-2:
> 150 000 Martindale
invers/inverse/inverso
ASTM D4157 / CFFA-1A:
≥ 50,000
Abrieb Wyzenbeek
double rubs Wyzenbeek
doble frota Wyzenbeek



erfüllt Medizinproduktegesetz
fulfills medical standard
cumple la normativa para
productos sanitarios
DIN EN ISO 10993-5+10



blut- und urinbeständig
blood- and urine resistant
resistente a la sangre
y a la orina



reißfest
tear resistant
resistente al desgarro



pflegeleicht
easy to clean
fácil mantenimiento



langlebig
long-lasting
larga vida útil



lichtecht
lightfast
resistente a la luz



desinfektionsmittelbeständig
disinfectant resistant
resistente a los desinfectantes



schwer entflammbar
flame protection
resistencia al fuego
DIN EN1021-1+2,
BS 5852 IS-O+1, CA TB
117-2013, UFAC/NFPA260
Class 1, compliant with
CAL AB 2998



phthalatfrei
phthalate-free
no contiene ftalatos



nachhaltig
sustainable
sostenible



vegan
vegan
vegano



0161/2023
IMO FTPC 2010 Part 8

Anwendung / Verarbeitung

Geeignet für viele Arten von Bepolsterungen und Bespannungen in der Polsterindustrie, besonders für den Einsatz im Medizin- und Physiotherapiebereich. Bei sachgemäßer Anwendung sind nach DIN EN ISO 10993-5 keine zytotoxischen Effekte und nach DIN EN ISO 10993-10 keine primären Hautirritationen zu erwarten. Problemlose Verarbeitung nach den üblichen Verfahren (Nähen, Heften, Kleben, Nageln). Keine eingefärbten Kleber oder Lösemittelkleber verwenden!

Sonstige Hinweise

Zum Erhalt der Materialeigenschaften Ihres skai® Produktes ist eine regelmäßige Reinigung der Materialoberfläche erforderlich. Benutzen Sie hierzu eine warme, milde Seifenlaugung und ein Mikrofasertuch oder eine weiche Handbürste. Bitte verwenden Sie keine chemischen Bleichen oder scheuernde Reinigungsmittel. Bitte beachten Sie, dass Anfarbungen des Materials durch Jeans oder andere Textilien von jeglicher Gewährleistung ausgenommen sind.

Besondere Hinweise

Unsere anwendungstechnischen Empfehlungen in Wort und Schrift, die wir aufgrund unserer Erfahrung entsprechend dem aktuellen Stand der Technik weitergeben, sind unverbindlich. Sie entbinden den Käufer nicht davon, die Eignung unsere Produkte für den vorgesehenen Verwendungszweck in eigener Verantwortung selbst zu prüfen. Dies gilt insbesondere für alle Komponenten, die zusammen mit unserem Produkt verarbeitet werden und deren Verträglichkeit im Verbund. Im Übrigen gelten unsere allgemeinen Geschäftsbedingungen. Hiermit verlieren alle früheren, anderslautenden Regelungen ihre Gültigkeit.

Application / Processing

Suitable for many kinds of upholsteries and coverings in the upholstery industry, especially for couches in the medical and physiotherapy area. By proper use no cytotoxic effects (according DIN EN ISO 10993-5) and no primary skin irritations (according DIN EN ISO 10993-10) are to be expected. Problem-free processing in the usual procedures (sewing, tacking, sticking, nailing). Do not use colored adhesives or solvent adhesives!

Other instructions

To maintain the material properties of your skai® product, it is necessary to regularly clean the material surface. Use a warm, mild soap solution and a microfiber cloth or a soft hand brush for this purpose. Please do not use chemical bleach or abrasive cleaning agents. Please note that staining of the material through jeans or other textiles is excluded from any warranty.

Special notes

Our spoken and written application engineering recommendations, which we pass on based on our experience and in accordance with the current state of the art, are non-binding. They do not absolve buyers of their own responsibility to check the suitability of our products for the intended purpose. This applies in particular to all components that are processed together with our product and their compatibility in combination with each other. Otherwise, our general terms and conditions are in effect. All earlier provisions to the contrary hereby become invalid.

Aplicaciones / Manipulación

Adecuado para todo tipo de tapizados y revestimientos en el sector de la tapicería, especialmente en el ámbito de la medicina y la fisioterapia. Siempre y cuando se use correctamente, no se prevén efectos citotóxicos según la norma UNE-EN ISO 10993-5 ni irritaciones cutáneas primarias según la norma UNE-EN ISO 10993-10. Aplicación sencilla por medio de procedimientos habituales (cosido, hilvanado, pegado, clavado). ¡No utilizar adhesivos tintados ni a base de disolventes!

Otros consejos

Para conservar las propiedades del material de su producto de skai® es necesario limpiar regularmente la superficie del material. Utilice para ello lejía jabonosa suave y tibia con un paño de microfibra o un cepillo de mano suave. No utilice blanqueadores químicos ni productos de limpieza abrasivos. Tenga en cuenta que las manchas por decoloración en el material causadas por pantalones vaqueros u otros tejidos quedan excluidas de cualquier garantía.

Advertencias especiales

Las recomendaciones de aplicaciones técnicas que ofrecemos, ya sea de palabra o por escrito, en base a nuestra experiencia y conforme a los avances tecnológicos actuales, no son vinculantes. En ningún caso eximirán al comprador de comprobar por sí mismo y bajo su propia responsabilidad la idoneidad de nuestros productos para la finalidad de uso prevista. Esto se aplica especialmente para todos aquellos componentes que se utilicen junto con nuestro producto y su compatibilidad al combinarlos. En todo lo demás, se aplicarán nuestras condiciones generales, lo que supone la nulidad de cualquier otro acuerdo previo.



* nach den gesetzlichen Bestimmungen
prescribed by law
de conformidad con las disposiciones legales



Nachwachsende
Rohstoffe
Renewable
raw material
Materias
primas renovables



phthalatfrei
phthalate-free
no contiene ftalatos

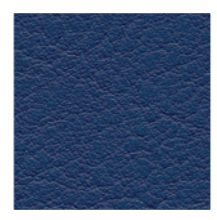

nachhaltig
sustainable
sostenible

Natürliche
Rohstoffe
Natural
raw material
Materias primas
naturales



Continental 
The Future in Motion

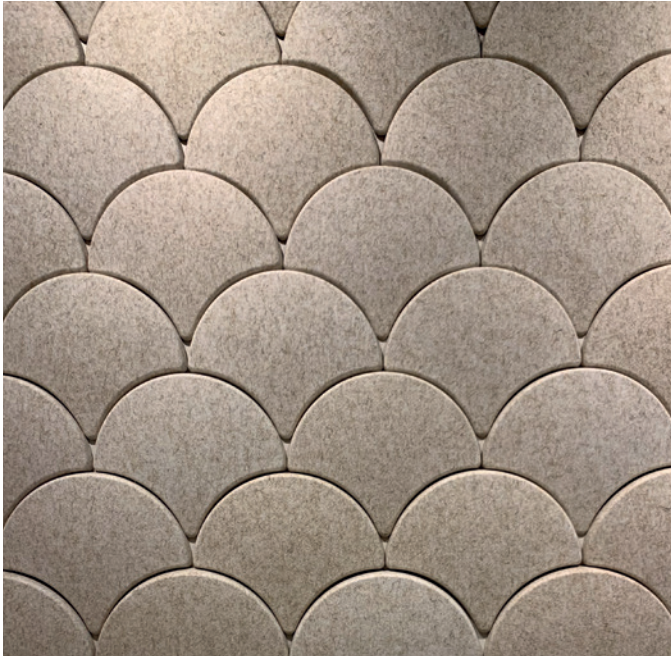

skai® Evida Fiber
Sustainability

90%
natural and
renewable raw
materials



Mit einer feinen faserartigen Struktur, die den nachhaltigen Charakter des Materials unterstreicht, spielt skai® Evida Fiber seinen Charme visuell gekonnt aus. Die Optik: ein Highlight, das am Objekt dank breiter Farbränge zum Eyecatcher wird. Die Haptik: angenehm weich. Das Geheimnis des Materials: Es besteht zu 90% aus natürlichen und nachwachsenden Inhaltsstoffen.

With its multifaceted grain in a deliberately sustainable look and a fibrous texture, skai® Evida Fiber is a synthetic leather that cleverly exploits its appeal in visual terms. The look: a highlight that becomes an eye-catcher on the object thanks to broad color palette. Its feel is pleasantly soft. The secret of the material is that it consists of 90% natural and renewable resources.

Con un veteado variado, un aspecto conscientemente sostenible y una fibrosa estructura, la skai® Evida Fiber es una piel sintética que despliega con acierto su encanto visual. El aspecto: un efecto especial que llama la atención gracias a la amplia gama de colores. El tacto: agradablemente suave. El secreto del material: está compuesto en un 90% por materias primas naturales y renovables.



skai® Evida Fiber organic green F6800101

skai® Evida Fiber



cloud white F6800102



cream F6800103

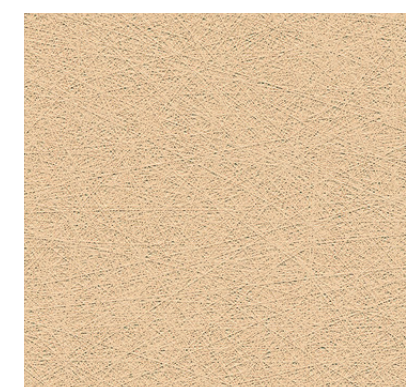

sand stone F6800108



ashgrey F6800114



lightgrey F6800104



rosy brown F6800105



come closer! F6800106



blush F6800107

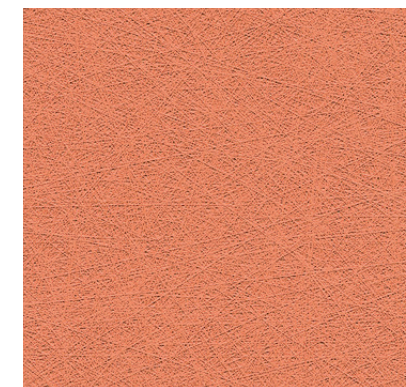

orange rust F6800112



gobi F6800113

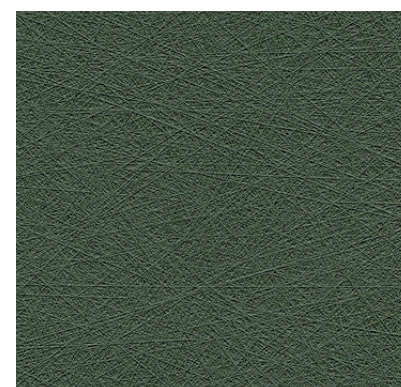

dark moss F6800110



olive green F6800109

Keine Urmuster hinsichtlich Farbe und Qualität. No counter samples regarding to colour and quality. No constituye una muestra de referencia en cuanto a color y calidad.

skai® Evida Fiber

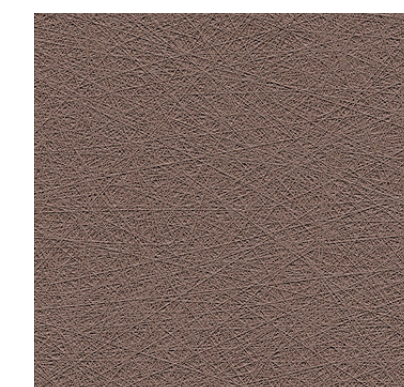

earth F6800111



anthracite F6800115



black F6800116

skai® Evida Fiber verringert den ökologischen Fußabdruck

- > Eingesetzte Komponenten bestehen zu mehr als 90% aus natürlichen und nachwachsenden Rohstoffen
- > Phthalatfreier Weichmacher auf Basis nachwachsender Rohstoffe
- > Hoher Qualitätsstandard, engineered and made in Germany (ISO9001)
- > Einsatz lokaler und regionaler Rohstoffe (EU)
- > 100% CO₂-neutraler Energie-Einsatz im Herstellungsprozess auf Basis erneuerbarer Energiequellen

skai® Evida Fiber Reduces Ecological Footprint

- > Components used are made from more than 90% natural and renewable raw materials
- > Use of phthalate-free plasticizers based on renewable raw materials
- > High quality standard, engineered and made in Germany (ISO9001)
- > Use of local and regional raw materials (EU)
- > Use of 100% CO₂-neutral energy in the manufacturing process based on renewable energy sources

skai® Evida Fiber reduce la huella ecológica

- > Más del 90% de los componentes utilizados son materias primas naturales y renovables
- > Plastificantes sin ftalatos basados en materias primas renovables
- > Alto estándar de calidad, diseñado y fabricado en Alemania (ISO9001)
- > Utilización de materias primas locales y regionales (UE)
- > Energía neutra con 100% del CO₂ utilizado en el proceso de fabricación basado en fuentes de energía renovables

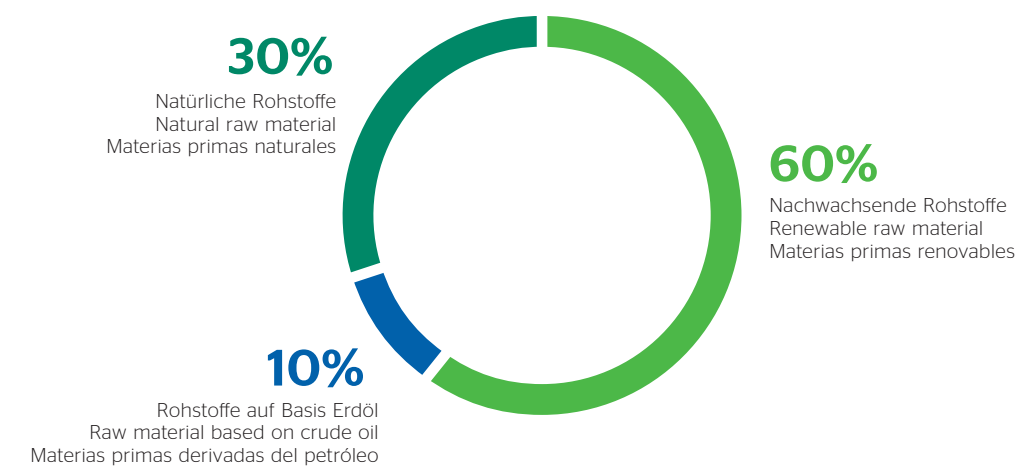



Public Area



Hospitality



Residential



Healthcare

Materialzusammensetzung:

ca. 60% nachwachsende Rohstoffe
ca. 30% natürliche Rohstoffe
ca. 10% erdölbasierende Rohstoffe
Gewicht: 750 +/- 50 g/m²
Dicke: 1,05 +/- 0,2 mm
Rollenbreite: 137 cm
Rollenlänge: 30m

Material composition:

approx. 60% renewable raw materials
approx. 30% natural based raw materials
approx. 10% raw materials based on crude oil
Weight: 750 +/- 50 g/m²
33.1 +/- 2.2 oz/yd
Thickness: 1,05 +/- 0.2 mm
Roll width: 137 cm / 54 in
Roll length: 30m / 32.8 yd

Composición del material:

aprox. 60% de materias primas renovables
aprox. 30% de materias primas naturales
aprox. 10% de materias primas derivadas del petróleo
Peso: 750 +/- 50 g/m²
Espesor: 1,05 +/- 0,2 mm
Ancho de rollo: 137cm
Largo de rollo: 30m



erfüllt Öko-Tex Standard 100
fulfills Öko-Tex Standard 100
Cumple la norma Öko-Tex 100



umweltfreundlich
environmentally friendly
ecológico



erfüllt Spielzeugnorm
fulfills toys norm
Cumple la norma para juguetes
DIN EN 71-3



abriebfest
abrasion resistant
resistencia a la abrasión
DIN EN ISO 5470-2:
>100 000 Martindale
invers/inverse/inverso



erfüllt Medizinproduktegesetz
fulfills medical standard
cumple la normativa para
productos sanitarios
DIN EN ISO 10993-5+10



blut- und urinbeständig
blood- and urine resistant
resistente a la sangre
y a la orina



reißfest
tear resistant
resistente al desgarro



pflegeleicht
easy to clean
fácil mantenimiento



langelig
long-lasting
larga vida útil



lichtecht
lightfast
resistente a la luz



desinfektionsmittelbeständig
disinfectant resistant
resistente a los desinfectantes



schwer entflammbar
flame protection
resistencia al fuego
DIN EN1021-1+2,
BS 5852 IS-O+1, CA TB
117-2013, UFAC/NFPA260
Class 1, compliant with
CAL AB 2998



phthalatfrei
phthalate-free
no contiene ftalatos



nachhaltig
sustainable
sostenible



vegan
vegan
vegano



0161/2023
IMO FTPC 2010 Part 8

Anwendung / Verarbeitung

Geeignet für viele Arten von Bepolsterungen und Bespannungen in der Polsterindustrie. Besonders geeignet für den Einsatz im trendorientierten Wohn- und Objektbereich, in öffentlichen Gebäuden und Einrichtungen. Problemlose Verarbeitung nach den üblichen Verfahren (Nähen, Heften, Kleben, Nageln). Keine eingefärbten Kleber oder Lösemittelkleber verwenden!

Sonstige Hinweise

Zum Erhalt der Materialeigenschaften Ihres skai® Produktes ist eine regelmäßige Reinigung der Materialoberfläche erforderlich. Benutzen Sie hierzu den skai® Reiniger oder eine warme, milde Seifenlauge und ein Mikrofasertuch. Bitte verwenden Sie keine chemischen Bleichen oder scheuernde Reinigungsmittel. Bitte beachten Sie, dass Anfärbungen des Materials durch Jeans oder andere Textilien von jeglicher Gewährleistung ausgenommen sind.

Besondere Hinweise

Unsere anwendungstechnischen Empfehlungen in Wort und Schrift, die wir aufgrund unserer Erfahrung entsprechend dem aktuellen Stand der Technik weitergeben, sind unverbindlich. Sie entbinden den Käufer nicht davon, die Eignung unsere Produkte für den vorgesehenen Verwendungszweck in eigener Verantwortung selbst zu prüfen. Dies gilt insbesondere für alle Komponenten, die zusammen mit unserem Produkt verarbeitet werden und deren Verträglichkeit im Verbund. Im Übrigen gelten unsere allgemeinen Geschäftsbedingungen. Hiermit verlieren alle früheren, anderslautenden Regelungen ihre Gültigkeit.

Application / Processing

Suitable for many kinds of upholsterys and coverings in the upholstery industry. Especially suitable for the use in the modern residential and contract area, in public buildings and institutions. Problem-free processing in the usual procedures (sewing, tacking, sticking, nailing). Do not use colored adhesives or solvent adhesives!

Other instructions

To maintain the material properties of your skai® product, it is necessary to regularly clean the material surface. For cleaning, please use skai® cleaning agent or a warm, mild soapy water and a microfiber cloth. Please do not use chemical bleach or abrasive cleaning agents. Please note that staining of the material through jeans or other textiles is excluded from any warranty.

Special notes

Our spoken and written application engineering recommendations, which we pass on based on our experience and in accordance with the current state of the art, are non-binding. They do not absolve buyers of their own responsibility to check the suitability of our products for the intended purpose. This applies in particular to all components that are processed together with our product and their compatibility in combination with each other. Otherwise, our general terms and conditions are in effect. All earlier provisions to the contrary hereby become invalid.

Aplicaciones / Manipulación

Adecuado para numerosos tipos de tapizados y revestimientos en el sector de la tapicería. Especialmente adecuado para su uso en el ámbito residencial exclusivo y de tendencia y en instalaciones y edificios públicos. Aplicación sencilla por medio de procedimientos habituales (cosido, hilvanado, pegado, clavado). ¡No utilizar adhesivos tintados ni a base de disolventes!

Otros consejos

Para conservar las propiedades del material de su producto de skai® es necesario limpiar regularmente la superficie del material. Para ello, utilice skai® limpiador o agua jabonosa caliente y suave y un paño de microfibra. No utilice blanqueadores químicos ni productos de limpieza abrasivos. Tenga en cuenta que las manchas por decoloración en el material causadas por pantalones vaqueros u otros tejidos quedan excluidas de cualquier garantía.

Advertencias especiales

Las recomendaciones de aplicaciones técnicas que ofrecemos, ya sea de palabra o por escrito, en base a nuestra experiencia y conforme a los avances tecnológicos actuales, no son vinculantes. En ningún caso eximirán al comprador de comprobar por sí mismo y bajo su propia responsabilidad la idoneidad de nuestros productos para la finalidad de uso prevista. Esto se aplica especialmente para todos aquellos componentes que se utilicen junto con nuestro producto y su compatibilidad al combinarlos. En todo lo demás, se aplicarán nuestras condiciones generales, lo que supone la nulidad de cualquier otro acuerdo previo.



* nach den gesetzlichen Bestimmungen prescribed by law de conformidad con las disposiciones legales



Continental 
The Future in Motion



skai® VyP Coffee
Sustainability



65%
natural and
recycled
ingredients



VyP Coffee



Ein atmungsaktiver Polsterbezugstoff mit grünem Daumen. Bei der Herstellung dieses besonderen Materials wird auf recycelte und natürliche Komponenten zurückgegriffen. Revolutionär ist dabei, dass es Continental gelungen ist, Kaffeesatz in den Produktionsprozess einzubeziehen.

A breathable upholstery material with true green credentials. Recycled and natural components are used for the production of this particular material. What is revolutionary about this product is that Continental has succeeded in using coffee grounds as part of the production process.

Un tejido de tapicería transpirable basado en plantas. Para la producción de este material especial se utilizan componentes reciclados y naturales. Sin embargo, lo revolucionario del proceso es que Continental ha conseguido incorporar posos de café a la producción.



skai® VyP Coffee dark roast F7901036

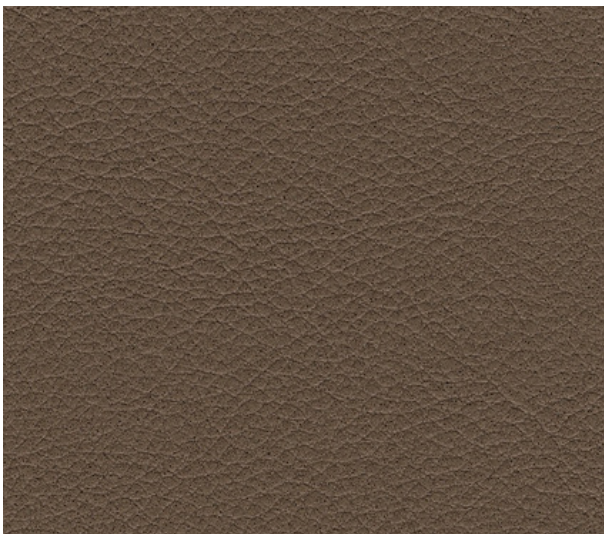

mocca F7901037

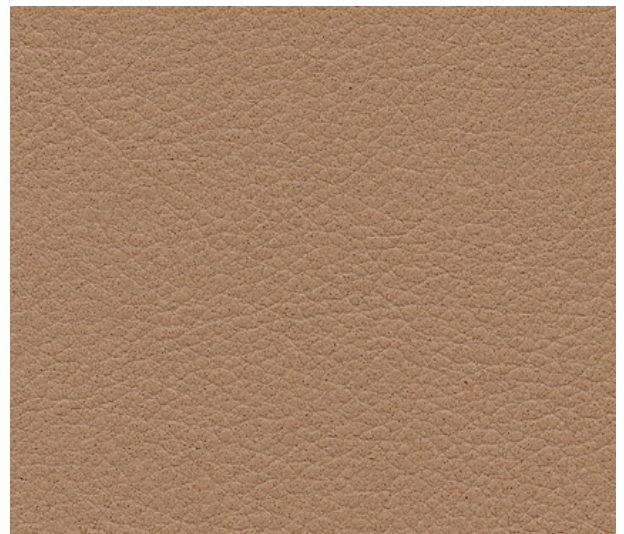

latte macchiato F7901038

Keine Urmuster hinsichtlich Farbe und Qualität. Aufgrund der natürlichen Farbgebung von Kaffee ist eine chargenreine Verarbeitung empfohlen. Abweichungen im Farbausfall sind möglich. | No counter samples regarding to colour and quality. Due to the natural coloring of coffee, batch-pure processing is recommended. Deviations in color appearance are possible. | No constituye una muestra de referencia en cuanto a color y calidad. Debido a la coloración natural del café, se recomienda la elaboración por lotes. Son posibles variaciones en el aspecto del color.



Public Area



Hospitality



Residential

Materialzusammensetzung:

ca. 66 % Vinyl/PU-Compound
 ca. 34 % recyceltes BW/PES-Gestrick
Gewicht: 690 +/- 50 g/m²
Dicke: 1,4 +/- 0,2 mm
Rollenbreite: 140 cm
Rollenlänge: 30 m

Material composition:

approx. 66 % Vinyl/PU-compound
 approx. 34 % recycled CO/PES-knitted fabric
Weight: 690 +/- 50 g/m²
 32.5 +/- 2.3 oz/yd
Thickness: 1.4 +/- 0.2 mm
Roll width: 140 cm / 55.1 in
Roll length: 30 m / 32.8 yd

Composición del material:

aprox. 66 % compuesto de Vinilo/PU
 aprox. 34 % reciclaje soporte textil de punto de algodón/PES
Peso: 690 +/- 50 g/m²
Espesor: 1,4 +/- 0,2 mm
Ancho de rollo: 140 cm
Largo de rollo: 30 m



atmungsaktiv
 breathable
 transpirable



reißfest
 tear resistant
 resistente al desgarro



pflegeleicht
 easy to clean
 fácil mantenimiento



abriebfest
 abrasion resistant
 resistencia a la abrasión
DIN EN ISO 5470-2:
 ≥ 100 000 Martindale



langlebig
 long-lasting
 larga vida útil



lichtecht
 lightfast
 resistente a la luz
DIN EN ISO 105-B02,
 Stufe 6 / level 6 / nivel 6



dehnfähig
 extensible
 extensible



schwer entflammbar
 flame protection
 resistencia al fuego
DIN EN 1021-1+2,
BS 5852 IS-O+1, MVSS
302, IMO FTPC P8,
CA TB 117-2013, UFAC/
NFPA260 Class 1,
compliant with CAL
AB 2998



phthalatfrei
 phthalate-free
 no contiene ftalatos



Träger aus recycelter BW/PES Faser
 Recycled CO/PES fibre backing
 Soporte de fibra algodón /PES
 reciclada



0161/2023
 IMO FTPC 2010 Part 8



vegan
 vegan
 vegano



nachhaltig
 sustainable
 sostenible

Anwendung / Verarbeitung

Geeignet für viele Arten von Bepolsterungen und Spannungen in der Polsterindustrie. Besonders geeignet für den Einsatz im trendorientierten Wohn- und Objektbereich, in öffentlichen Gebäuden und Einrichtungen. Problemlose Verarbeitung nach den üblichen Verfahren (Nähen, Heften, Kleben, Nageln). Keine eingefärbten Kleber oder Lösemittelkleber verwenden!

Sonstige Hinweise

Zum Erhalt der Materialeigenschaften Ihres skai® Produktes ist eine regelmäßige Reinigung der Materialoberfläche erforderlich. Benutzen Sie hierzu eine warme, milde Seifenlauge und ein Mikrofasertuch oder eine weiche Handbürste. Bitte verwenden Sie keine chemischen Bleichen oder scheuernde Reinigungsmittel. Bitte beachten Sie, dass Anfärbungen des Materials durch Jeans oder andere Textilien von jeglicher Gewährleistung ausgenommen sind.

Besondere Hinweise

Unsere anwendungstechnischen Empfehlungen in Wort und Schrift, die wir aufgrund unserer Erfahrung entsprechend dem aktuellen Stand der Technik weitergeben, sind unverbindlich. Sie entbinden den Käufer nicht davon, die Eignung unsere Produkte für den vorgesehenen Verwendungszweck in eigener Verantwortung selbst zu prüfen. Dies gilt insbesondere für alle Komponenten, die zusammen mit unserem Produkt verarbeitet werden und deren Verträglichkeit im Verbund. Im Übrigen gelten unsere allgemeinen Geschäftsbedingungen. Hiermit verlieren alle früheren, anderslautenden Regelungen ihre Gültigkeit.

Application / Processing

Suitable for many kinds of upholsterys and coverings in the upholstery industry. Especially suitable for the use in the modern residential and contract area, in public buildings and institutions. Problem-free processing in the usual procedures (sewing, tacking, sticking, nailing). Do not use colored adhesives or solvent adhesives!

Other instructions

To maintain the material properties of your skai® product, it is necessary to regularly clean the material surface. Use a warm, mild soap solution and a microfiber cloth or a soft hand brush for this purpose. Please do not use chemical bleach or abrasive cleaning agents. Please note that staining of the material through jeans or other textiles is excluded from any warranty.

Special notes

Our spoken and written application engineering recommendations, which we pass on based on our experience and in accordance with the current state of the art, are non-binding. They do not absolve buyers of their own responsibility to check the suitability of our products for the intended purpose. This applies in particular to all components that are processed together with our product and their compatibility in combination with each other. Otherwise, our general terms and conditions are in effect. All earlier provisions to the contrary hereby become invalid.

Aplicaciones / Manipulación

Apto para múltiples tipos de tapizado y revestimientos para la industria del mueble tapizado. Especialmente diseñado para el empleo en espacios modernos tanto públicos como privados, en edificios públicos e instituciones. Aplicación sencilla por medio de procedimientos habituales (cosido, hilvanado, pegado, clavado). ¡No utilizar adhesivos tintados ni a base de disolventes!

Otros consejos

Para conservar las propiedades del material de su producto de skai® es necesario limpiar regularmente la superficie del material. Utilice para ello lejía jabonosa suave y tibia con un paño de microfibra o un cepillo de mano suave. No utilice blanqueadores químicos ni productos de limpieza abrasivos. Tenga en cuenta que las manchas por decoloración en el material causadas por pantalones vaqueros u otros tejidos quedan excluidas de cualquier garantía.

Advertencias especiales

Las recomendaciones de aplicaciones técnicas que ofrecemos, ya sea de palabra o por escrito, en base a nuestra experiencia y conforme a los avances tecnológicos actuales, no son vinculantes. En ningún caso eximirán al comprador de comprobar por sí mismo y bajo su propia responsabilidad la idoneidad de nuestros productos para la finalidad de uso prevista. Esto se aplica especialmente para todos aquellos componentes que se utilicen junto con nuestro producto y su compatibilidad al combinarlos. En todo lo demás, se aplicarán nuestras condiciones generales, lo que supone la nulidad de cualquier otro acuerdo previo.



* nach den gesetzlichen Bestimmungen prescribed by law de conformidad con las disposiciones legales



Continental 
The Future in Motion

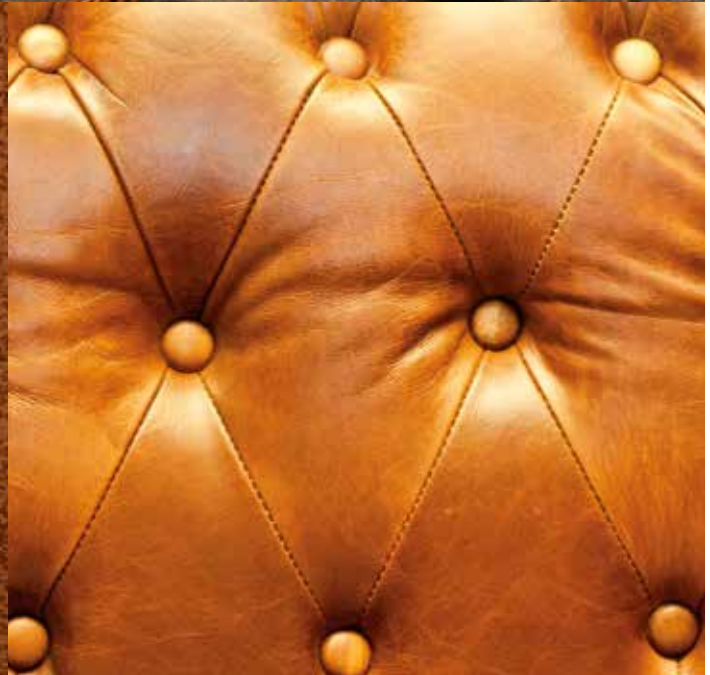

Leather Design FR

Continental 
The Future in Motion



skai® Parotega NF, skai® Palma NF
Leather Design FR

Hochwertiges skai® Material mit klassischer Ledernarbung. Durch seine naturgetreue Optik und Haptik ist das Material von Echtleider kaum zu unterscheiden. Das Material ist insbesondere für den Objektbereich, für öffentliche Gebäude und Einrichtungen geeignet.

High-quality skai® material with a classic leather grain. Due to its natural look and touch one can hardly differentiate between this material and genuine leather. The material is especially suitable for the contract area, for public buildings and institutions.

Un material skai® de alta calidad con textura de cuero clásico. Gracias a su estética y su tacto naturales, este material apenas se distingue del cuero auténtico. Este producto es especialmente idóneo e el ámbito de la decoración, las instalaciones y edificios públicos.

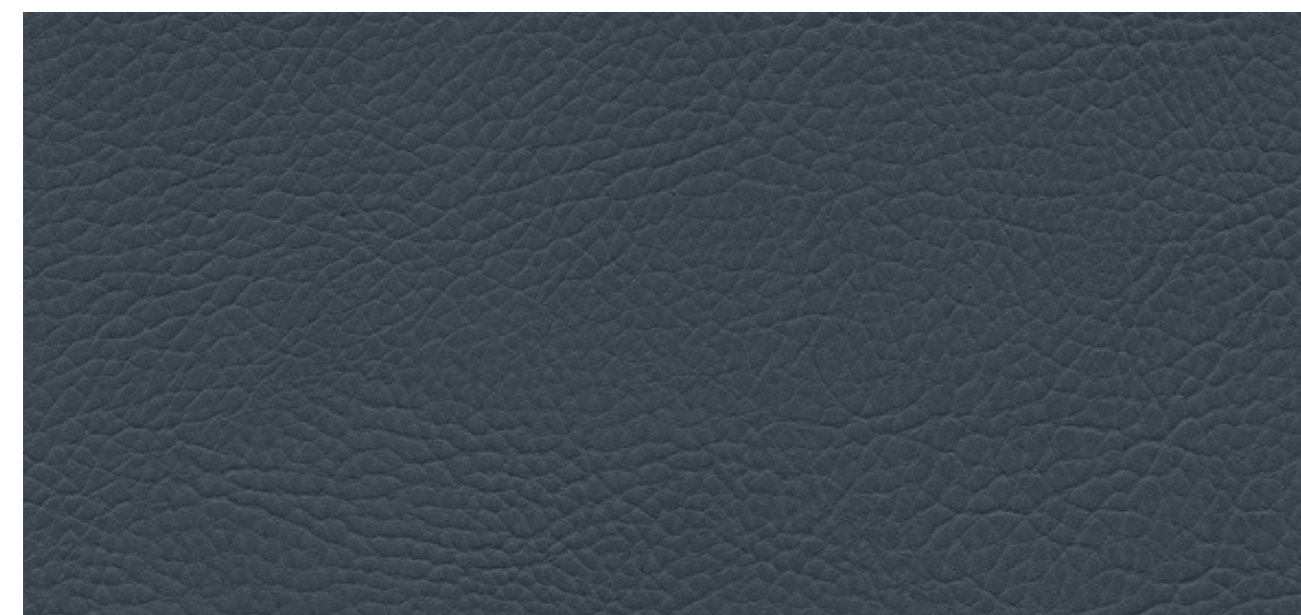

skai® Parotega NF stone blue F6461770

Hochwertiges skai® Material mit feiner Kalbsledernarbung und einem dezenten Druckbild. Das Material ist universell einsetzbar und für den Objektbereich, für öffentliche Gebäude und Einrichtungen geeignet.

High-quality skai® material with a fine-structured calf leather grain and a subdued printing. The material is all-purpose and especially suitable for the contract area, for public buildings and institutions.

Un material skai® de alta calidad con el grano fino de cuero vacuno y un discreto motivo impreso. Este material admite un uso universal, en el ámbito de la decoración, las instalaciones y edificios públicos.

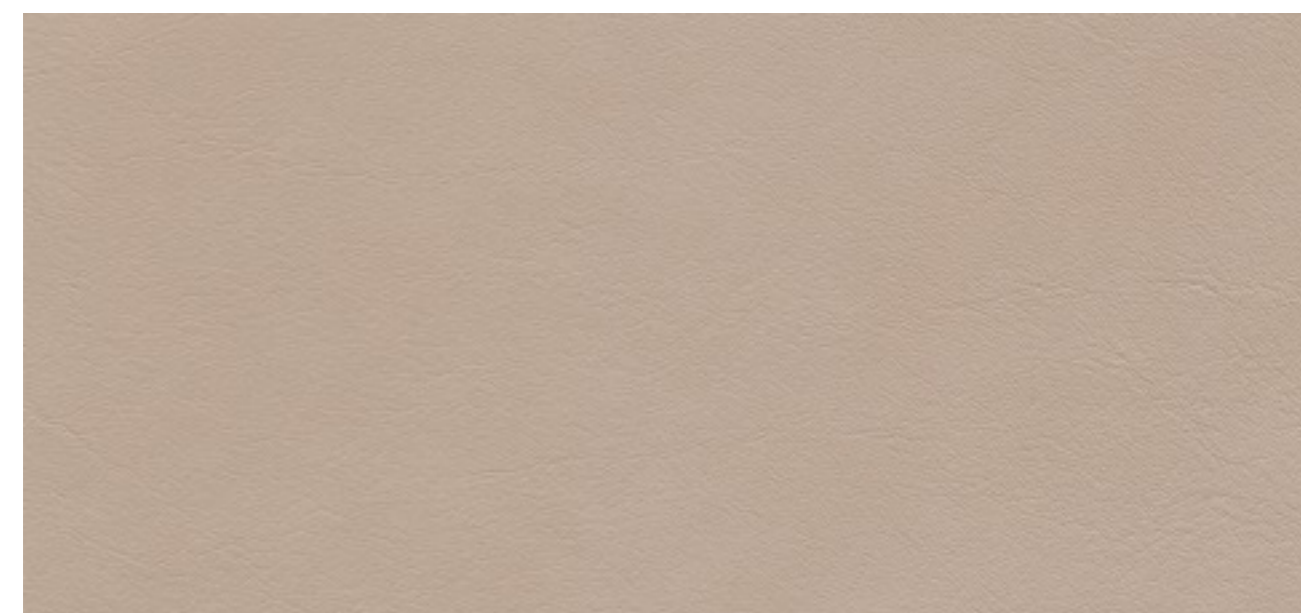

skai® Palma NF birke F6411152

skai® Parotega NF



weiss F6461652 hellbeige F6461632 kiesel F6461653 sattel F6461733



perle F6461662 birke F6461661 cappuccino F6461762 marone F6461655



cinder F6461763 smoke F6461660 olivbraun F6461704 schoko F6461656



light rosé F6461764 marsala F6461765 kirsche F6461665 * feuer F6461707



cashmere F6461737 mango F6461666 sherry F6461654 lachs F6461702

skai® Parotega NF



fango F6461658 mais F6461706 limone F6461657 olivgrün F6461705

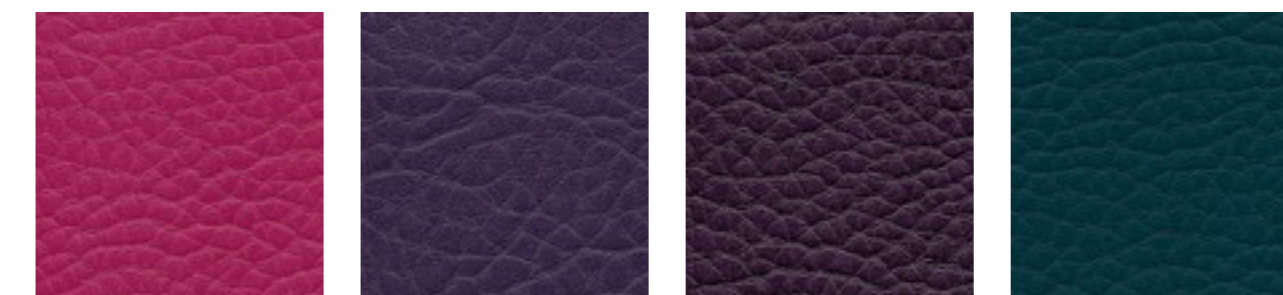

fuchsia F6461735 lila F6461736 amethyst F6461664 teal F6461766

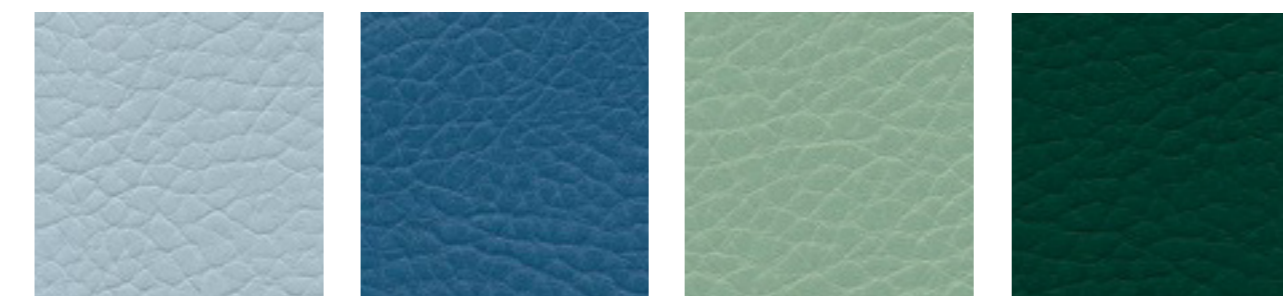

gletscher F6461708 aqua F6461709 mint F6461767 rain forest F6461768

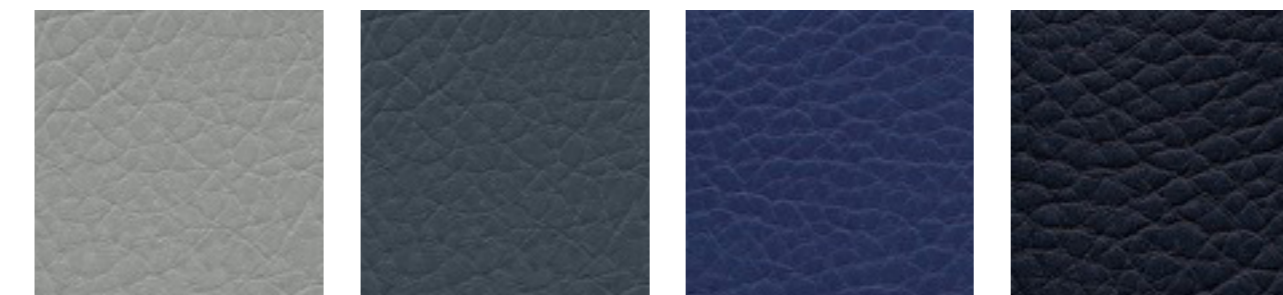

ashgrey F6461769 * stone blue F6461770 royal F6461710 nightblue F6461729*

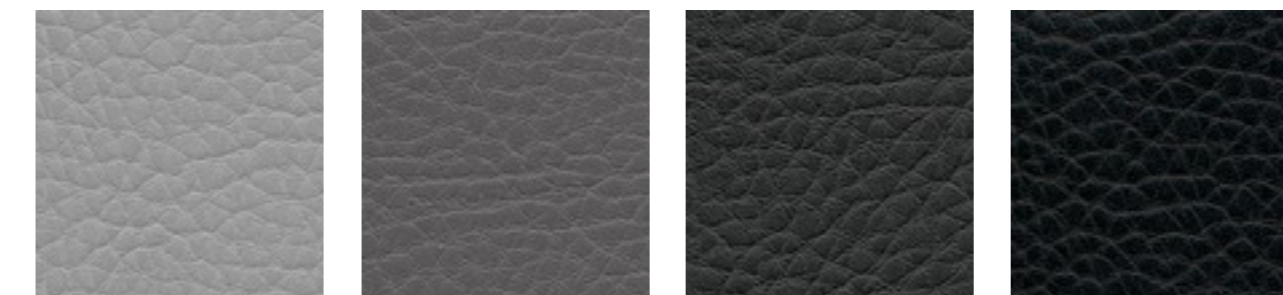

silbergrau F6461730 schiefergrau F6461731 anthrazit F6461663 schwarz F6461659

skai® Palma NF



weiss F6411143 perle F6411008 birke F6411152 smoke F6411153



inka F6411145 kenia F6411146 limone F6411195 olivgrün F6411196



torf F6411197 lachs F6411144 rubin F6411010 * amethyst F6411155



atoll F6411005 * baltic F6411006 rauchblau F6411198* kirsche F6411154 *



lichtgrau F6411199 platin F6411012 * anthrazit F6411160 schwarz F6411011



Public Area



Hospitality



Residential



Healthcare



Fitness

Materialzusammensetzung:

ca. 85 % PVC-Compound
ca. 15 % BW-Gestrick
Gewicht: 780 +/- 50 g/m²
Dicke: 1,3 +/- 0,2 mm
Rollenbreite: 137 cm
Rollenlänge: 30 m

Material composition:

approx. 85 % PVC-compound
approx. 15 % CO-knitted fabric
Weight: 780 +/- 50 g/m²
Thickness: 1.3 +/- 0.2 mm
Roll width: 137 cm
Roll length: 30 m

Composición del material:

aprox. 85 % compuesto de PVC
aprox. 15 % soporte textil de punto de algodón
Peso: 780 +/- 50 g/m²
Espesor: 1,3 +/- 0,2 mm
Ancho de rollo: 137 cm
Largo de rollo: 30 m



langlebig
long-lasting
larga vida útil



reißfest
tear resistant
resistente al desgarro



abriebfest
abrasion resistant
resistencia a la abrasión
DIN EN ISO 5470-2:
≥ 300 000 Martindale
invers/inverse/inverso



schwer entflammbar
flame protection
resistencia al fuego
DIN 4102-1 (Part 1, B1),
DIN EN 13501-1 B, s3, d0
DIN 66084 P-a,
NF M1, AM 18,
B55852 IS-0+1+5+7,
DIN EN 1021-1+2,
DIN 4102-1 (B2),
MVSS302, FAR 25.853,
UNI 9175/87 (1.1M),
ASTM E 84



pflegeleicht
easy to clean
fácil mantenimiento



blut- und urinbeständig
blood- and urine resistant
resistente a la sangre
y a la orina



desinfektionsmittelbeständig
disinfectant resistant
resistente a los
desinfectantes



lichtecht
lightfast
resistente a la luz
DIN EN ISO 105-B02,
Stufe 7 / level 7 / nivel 7
skai® Parotega ashgrey:
Stufe 6 / level 6 / nivel 6



O161/2023
IMO FTPC 2010 Part 8



vegan
vegan
vegano

Anwendung / Verarbeitung

Geeignet für viele Arten von Bepolsterungen und Bespannungen in der Polsterindustrie. Besonders geeignet für den Einsatz im trendorientierten Wohn- und Objektbereich, in öffentlichen Gebäuden und Einrichtungen. Problemlose Verarbeitung nach den üblichen Verfahren (Nähen, Heften, Kleben, Nageln). Keine eingefärbten Kleber oder Lösemittelkleber verwenden!

Sonstige Hinweise

Zum Erhalt der Materialeigenschaften Ihres skai® Produktes ist eine regelmäßige Reinigung der Materialoberfläche erforderlich. Benutzen Sie hierzu eine warme, milde Seifenlauge und ein Mikrofasertuch oder eine weiche Handbürste. Bitte verwenden Sie keine chemischen Bleichen oder scheuernde Reinigungsmittel. Bitte beachten Sie, dass Anfärbungen des Materials durch Jeans oder andere Textilien von jeglicher Gewährleistung ausgenommen sind.

Besondere Hinweise

Unsere anwendungstechnischen Empfehlungen in Wort und Schrift, die wir aufgrund unserer Erfahrung entsprechend dem aktuellen Stand der Technik weitergeben, sind unverbindlich. Sie entbinden den Käufer nicht davon, die Eignung unsere Produkte für den vorgesehenen Verwendungszweck in eigener Verantwortung selbst zu prüfen. Dies gilt insbesondere für alle Komponenten, die zusammen mit unserem Produkt verarbeitet werden und deren Verträglichkeit im Verbund. Im Übrigen gelten unsere allgemeinen Geschäftsbedingungen. Hiermit verlieren alle früheren, anderslautenden Regelungen ihre Gültigkeit.

Application / Processing

Suitable for many kinds of upholsteries and coverings in the upholstery industry. Especially suitable for the use in the modern residential and contract area, in public buildings and institutions. Problem-free processing in the usual procedures (sewing, tacking, sticking, nailing). Do not use colored adhesives or solvent adhesives!

Other instructions

To maintain the material properties of your skai® product, it is necessary to regularly clean the material surface. Use a warm, mild soap solution and a microfiber cloth or a soft hand brush for this purpose. Please do not use chemical bleach or abrasive cleaning agents. Please note that staining of the material through jeans or other textiles is excluded from any warranty.

Special notes

Our spoken and written application engineering recommendations, which we pass on based on our experience and in accordance with the current state of the art, are non-binding. They do not absolve buyers of their own responsibility to check the suitability of our products for the intended purpose. This applies in particular to all components that are processed together with our product and their compatibility in combination with each other. Otherwise, our general terms and conditions are in effect. All earlier provisions to the contrary hereby become invalid.

Aplicaciones / Manipulación

Apto para múltiples tipos de tapizado y revestimientos para la industria del mueble tapizado. Especialmente diseñado para el empleo en espacios modernos tanto públicos como privados, en edificios públicos e instituciones. Aplicación sencilla por medio de procedimientos habituales (cosido, hilvanado, pegado, clavado). ¡No utilizar adhesivos tintados ni a base de disolventes!

Otros consejos

Para conservar las propiedades del material de su producto de skai® es necesario limpiar regularmente la superficie del material. Utilice para ello lejía jabonosa suave y tibia con un paño de microfibra o un cepillo de mano suave. No utilice blanqueadores químicos ni productos de limpieza abrasivos. Tenga en cuenta que las manchas por decoloración en el material causadas por pantalones vaqueros u otros tejidos quedan excluidas de cualquier garantía.

Advertencias especiales

Las recomendaciones de aplicaciones técnicas que ofrecemos, ya sea de palabra o por escrito, en base a nuestra experiencia y conforme a los avances tecnológicos actuales, no son vinculantes. En ningún caso eximirán al comprador de comprobar por sí mismo y bajo su propia responsabilidad la idoneidad de nuestros productos para la finalidad de uso prevista. Esto se aplica especialmente para todos aquellos componentes que se utilicen junto con nuestro producto y su compatibilidad al combinarlos. En todo lo demás, se aplicarán nuestras condiciones generales, lo que supone la nulidad de cualquier otro acuerdo previo.



*nach den gesetzlichen Bestimmungen prescribed by law de conformidad con las disposiciones legales



Management System
IATF 16949:2016
ISO 9001:2015
www.tuv.com
ID 900018354



Management System
ISO 14001:2015
ISO 45001:2018
ISO 50001:2018
www.tuv.com
ID 900018354

skai® Parotega NF, skai® Palma NF





Continental
The Future in Motion



skai[®] Sotega FLS
Leather Design FR



Sotega FLS



Hochwertiges skai® Material in Softnappaqualität mit klassischer Ledernarbung. Durch seine naturgetreue Optik und Haptik ist das Material von Echtleder kaum zu unterscheiden.

High quality skai® material with soft nappa finish and a classic leather grain. Due to its natural look and touch one can hardly differentiate between this material and genuine leather.

Un material skai® de alta calidad con sensaciones de napa flexible y un grano de cuero clásico. Gracias a su estética y su tacto naturales, este material apenas se distingue del cuero auténtico.

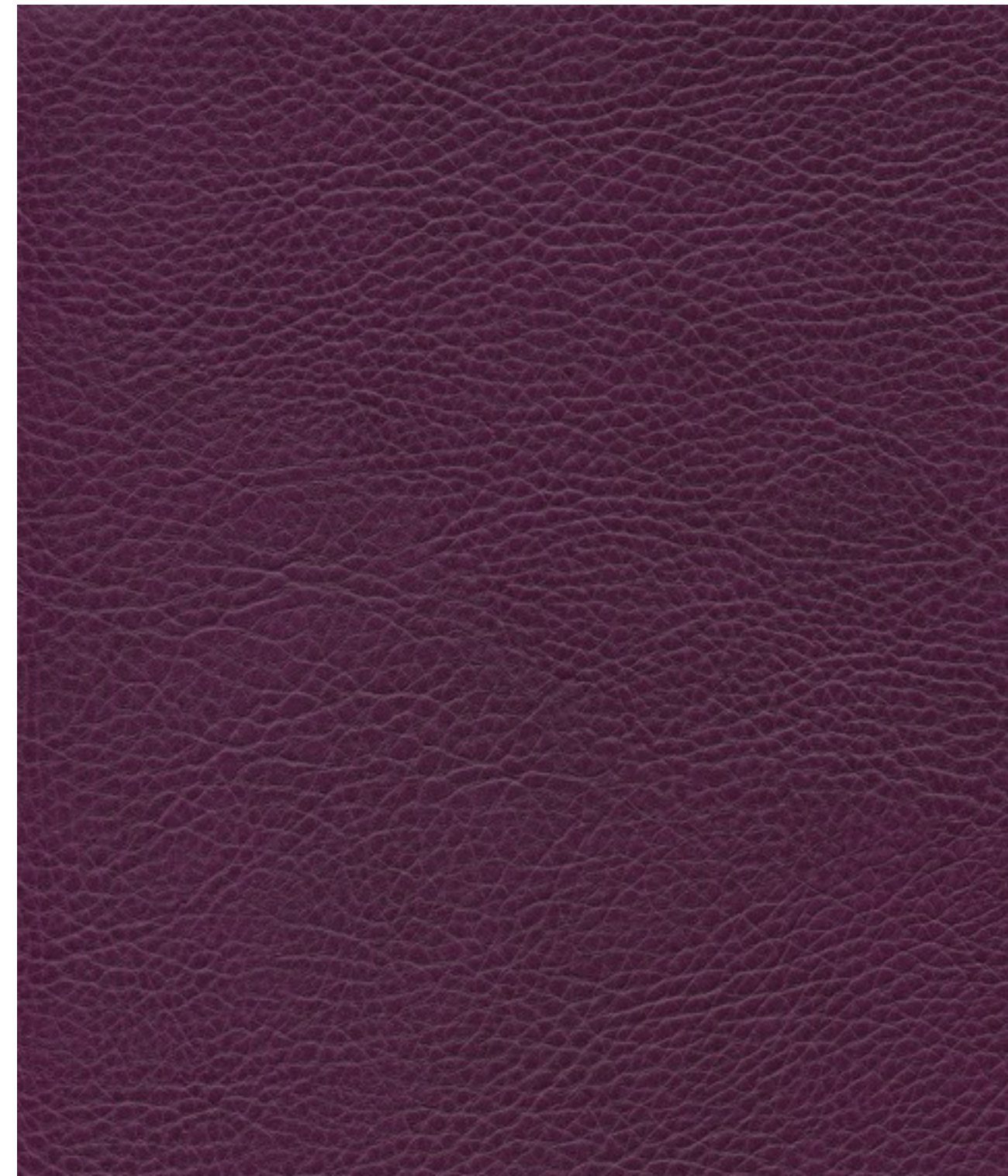

skai® Sotega FLS cyclam F5071180

skai® Sotega FLS

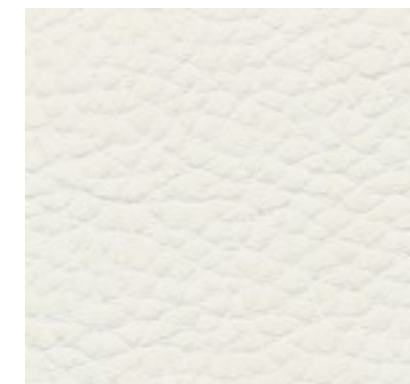

weiss F5070996

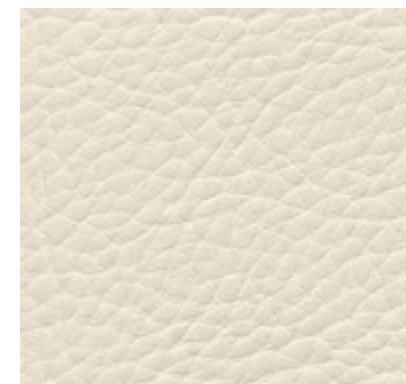

porcelain F5070983



hellbeige F5070795



beige F5071167



camel F5070794

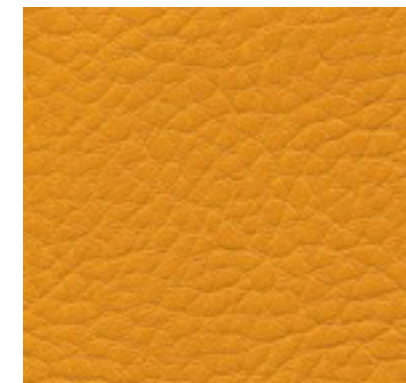

mango F5070958



birke F5071113



smoke F5071112



hazelnut F5071170



mahagoni F5071169



mocca F5070793



schoko F5071057

skai® Sotega FLS



cashmere F5071168

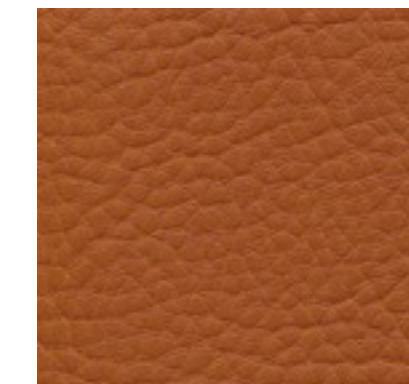

sherry F5070955

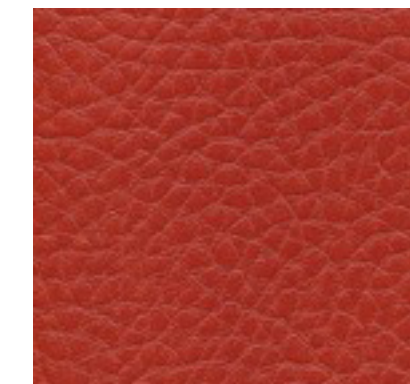

lachs F5070956

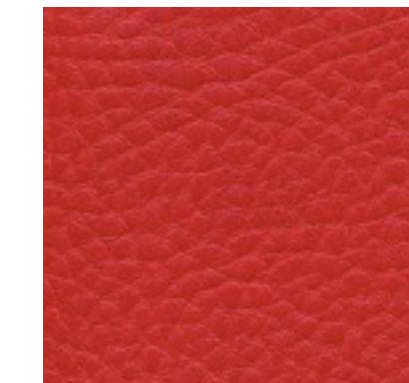

flame F5070957



carmin F5070792



petrol F5071181

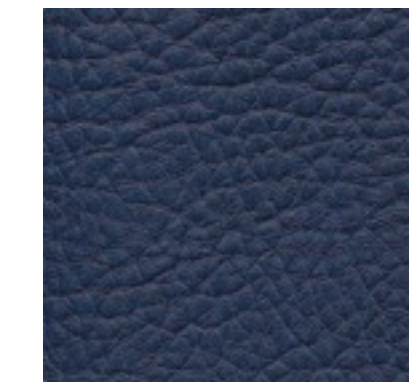

ocean F5070791

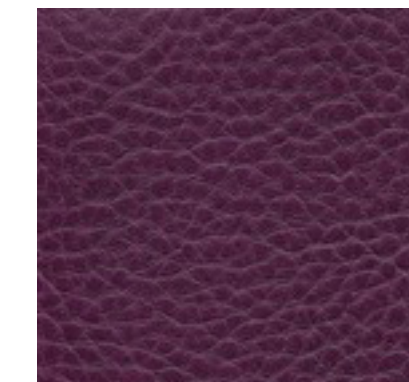

cyclam F5071180



purple F5071171



platin F5071182



darkgrey F5071172

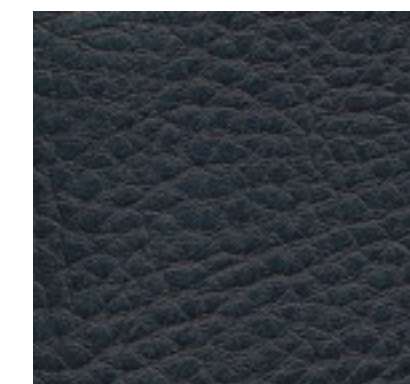

schwarz F5070796



Public Area



Hospitality



Residential

Materialzusammensetzung:

ca. 1 % PU-Finish
ca. 72 % PVC-Compound
ca. 27 % BW/PES-Gewebe
Gewicht: 740 +/- 50 g/m²
Dicke: 1,45 +/- 0,2 mm
Rollenbreite: 150 cm
Rollenlänge: 20 m

Material composition:

approx. 1 % PU-finish
approx. 72 % PVC-compound
approx. 27 % CO/PES-fabric
Weight: 740 +/- 50 g/m²
Thickness: 1.45 +/- 0.2 mm
Roll width: 150 cm
Roll length: 20 m

Composición del material:

aprox. 1 % de acabado de PU
aprox. 72 % compuesto de PVC
aprox. 27 % soporte textil de algodón/PES
Peso: 740 +/- 50 g/m²
Espesor: 1,45 +/- 0,2 mm
Ancho de rollo: 150 cm
Largo de rollo: 20 m



langlebig
long-lasting
larga vida útil



reißfest
tear resistant
resistente al desgarro



abriebfest
abrasion resistant
resistencia a la abrasión
DIN EN ISO 5470-2:
≥ 200 000 Martindale
invers/inverse/inverso



schwer entflammbar
flame protection
resistencia al fuego
NF M2, BS5852 IS-O+1+5,
DIN EN 1021-1+2,
DIN4102 (Part 1, B2),
MVSS302



pflegeleicht
easy to clean
fácil mantenimiento



lichtecht
lightfast
resistente a la luz



O161/2023
IMO FTPC 2010 Part 8



phthalatfrei
phthalate-free
no contiene ftalatos



lösungsmittelfrei
solvent free
exento de solvente



vegan
vegan
vegano

Anwendung / Verarbeitung

Geeignet für viele Arten von Bepolsterungen und Bespannungen in der Polsterindustrie, besonders für den Einsatz im trendorientierten und exklusiven Wohn- und Objektbereich. Ebenfalls geeignet für den Einsatz in der Taschen- und Lederwarenindustrie. Problemlose Verarbeitung nach den üblichen Verfahren (Nähen, Heften, Kleben, Nageln). Keine eingefärbten Kleber oder Lösemittelkleber verwenden!

Sonstige Hinweise

Zum Erhalt der Materialeigenschaften Ihres skai® Produktes ist eine regelmäßige Reinigung der Materialoberfläche erforderlich. Benutzen Sie hierzu eine warme, milde Seifenlauge und ein Mikrofaser Tuch oder eine weiche Handbürste. Bitte verwenden Sie keine chemischen Bleichen oder scheuernde Reinigungsmittel. Bitte beachten Sie, dass Anfärbungen des Materials durch Jeans oder andere Textilien von jeglicher Gewährleistung ausgenommen sind.

Besondere Hinweise

Unsere anwendungstechnischen Empfehlungen in Wort und Schrift, die wir aufgrund unserer Erfahrung entsprechend dem aktuellen Stand der Technik weitergeben, sind unverbindlich. Sie entbinden den Käufer nicht davon, die Eignung unsere Produkte für den vorgesehenen Verwendungszweck in eigener Verantwortung selbst zu prüfen. Dies gilt insbesondere für alle Komponenten, die zusammen mit unserem Produkt verarbeitet werden und deren Verträglichkeit im Verbund. Im Übrigen gelten unsere allgemeinen Geschäftsbedingungen. Hiermit verlieren alle früheren, anderslautenden Regelungen ihre Gültigkeit.

Application / Processing

Suitable for many kinds of upholsteries and coverings in the upholstery industry. Especially suitable in the modern and exclusive residential area and contract area. Also suitable for the use in the bags and leather goods industry. Problem-free processing in the usual procedures (sewing, tacking, sticking, nailing). Do not use colored adhesives or solvent adhesives!

Other instructions

To maintain the material properties of your skai® product, it is necessary to regularly clean the material surface. Use a warm, mild soap solution and a microfiber cloth or a soft hand brush for this purpose. Please do not use chemical bleach or abrasive cleaning agents. Please note that staining of the material through jeans or other textiles is excluded from any warranty.

Special notes

Our spoken and written application engineering recommendations, which we pass on based on our experience and in accordance with the current state of the art, are non-binding. They do not absolve buyers of their own responsibility to check the suitability of our products for the intended purpose. This applies in particular to all components that are processed together with our product and their compatibility in combination with each other. Otherwise, our general terms and conditions are in effect. All earlier provisions to the contrary hereby become invalid.

Aplicaciones / Manipulación

Adecuado para numerosos tipos de tapizados y revestimientos en el sector de la tapicería, especialmente para su uso en el ámbito residencial y de diseño exclusivo y de tendencia. Igualmente adecuado para su uso en la fabricación de bolsos y maletas y en marroquinería. Aplicación sencilla por medio de procedimientos habituales (cosido, hilvanado, pegado, clavado). ¡No utilizar adhesivos tintados ni a base de disolventes!

Otros consejos

Para conservar las propiedades del material de su producto de skai® es necesario limpiar regularmente la superficie del material. Utilice para ello lejía jabonosa suave y tibia con un paño de microfibra o un cepillo de mano suave. No utilice blanqueadores químicos ni productos de limpieza abrasivos. Tenga en cuenta que las manchas por decoloración en el material causadas por pantalones vaqueros u otros tejidos quedan excluidas de cualquier garantía.

Advertencias especiales

Las recomendaciones de aplicaciones técnicas que ofrecemos, ya sea de palabra o por escrito, en base a nuestra experiencia y conforme a los avances tecnológicos actuales, no son vinculantes. En ningún caso eximirán al comprador de comprobar por sí mismo y bajo su propia responsabilidad la idoneidad de nuestros productos para la finalidad de uso prevista. Esto se aplica especialmente para todos aquellos componentes que se utilicen junto con nuestro producto y su compatibilidad al combinarlos. En todo lo demás, se aplicarán nuestras condiciones generales, lo que supone la nulidad de cualquier otro acuerdo previo.



* nach den gesetzlichen Bestimmungen prescribed by law de conformidad con las disposiciones legales



Continental 
The Future in Motion



skai® Pavinto
Leather Design FR

Der hochwertige Polsterbezugstoff skai® Pavinto ist mit einer Rindslederoptik ausgestattet, die optisch starke Gebrauchsspuren aufweist. Brüche und optische Abnutzungen, aber auch die variantenreiche Narbung tragen zum authentisch wirkenden Vintage-Look bei.

The high-quality upholstery material skai® Pavinto has a cowhide look, which bears heavy signs of use. Cracks and visual wear, as well as the varying grain contribute to the authentic vintage look.

El producto para tapizado de alta calidad skai® Pavinto está dotado de una estética de cuero vacuno que imita los roces de un uso intenso. Sus roturas y desgastes visuales, pero también su grano variado, contribuyen a la autenticidad de este look vintage.



skai® Pavinto lightgrey F6411233



polar F6411180



lightbeige F6411181



cognac F6411186



tabacco F6411187



birch F6411182



smoke F6411183



wine F6411185



carmine F6411234



choco F6411184



black F6411190

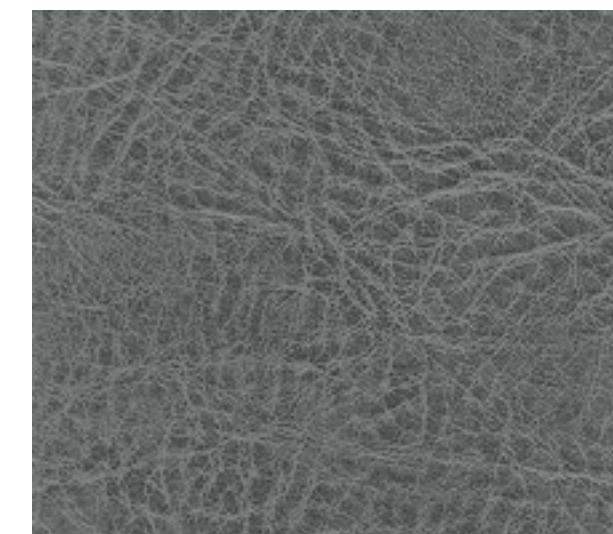

platinum F6411231



sea blue F6411232



Public Area



Hospitality



Residential



Fitness

Materialzusammensetzung:

ca. 89% PVC-Compound
ca. 11% BW/PES-Gestrick
Gewicht: 800 +/- 50 g/m²
Dicke: 1,4 +/- 0,2 mm
Rollenbreite: 137 cm
Rollenlänge: 30m

Material composition:

approx. 89% PVC-compound
approx. 11% CO/PES-knitted fabric
Weight: 800 +/- 50 g/m²
35.4 +/- 2.2 oz/yd
Thickness: 1.4 +/- 0.2 mm
Roll width: 137cm / 54 in.
Roll length: 30m / 32.8 yd

Composición del material:

aprox. 89% compuesto de PVC
aprox. 11% soporte textil de punto de algodón/PES
Peso: 800 +/- 50 g/m²
Espesor: 1,4 +/- 0,2 mm
Ancho de rollo: 137cm
Largo de rollo: 30m



langlebig
long-lasting
larga vida útil



reißfest
tear resistant
resistente al desgarro



abriebfest
abrasion resistant
resistencia a la abrasión
DIN EN ISO 5470-2:
≥ 150 000 Martindale
invers/inverse/inverso
ASTM D4157 / CFFA-1A:
≥ 50 000
Abrieb Wyzenbeek
double rubs Wyzenbeek
doble frotá Wyzenbeek



schwer entflammbar
flame protection
resistencia al fuego
NF M2, BS 5852 IS-O+1,
DIN EN 1021-1+2,
DIN 4102 (Part 1, B2),
MVSS 302, ÖNORM B 3825
schwer brennbar (B1),
UNI 9175/87 (1.1M),
CA TB 117-2013, UFAC/
NFPA260 Class1



pflegeleicht
easy to clean
fácil mantenimiento



lichtecht
lightfast
resistente a la luz



vegan
vegan
vegan



0161/2023
IMO FTFC 2010 Part 8

Anwendung / Verarbeitung

Geeignet für viele Arten von Bepolsterungen und Bespannungen in der Polsterindustrie. Besonders geeignet für den Einsatz im trendorientierten Wohn- und Objektbereich, in öffentlichen Gebäuden und Einrichtungen. Problemlose Verarbeitung nach den üblichen Verfahren (Nähen, Heften, Kleben, Nageln). Keine eingefärbten Kleber oder Lösemittelkleber verwenden!

Sonstige Hinweise

Zum Erhalt der Materialeigenschaften Ihres skai® Produktes ist eine regelmäßige Reinigung der Materialoberfläche erforderlich. Benutzen Sie hierzu eine warme, milde Seifenlauge und ein Mikrofaser Tuch oder eine weiche Handbürste. Bitte verwenden Sie keine chemischen Bleichen oder scheuernde Reinigungsmittel. Bitte beachten Sie, dass Anfärbungen des Materials durch Jeans oder andere Textilien von jeglicher Gewährleistung ausgenommen sind.

Besondere Hinweise

Unsere anwendungstechnischen Empfehlungen in Wort und Schrift, die wir aufgrund unserer Erfahrung entsprechend dem aktuellen Stand der Technik weitergeben, sind unverbindlich. Sie entbinden den Käufer nicht davon, die Eignung unsere Produkte für den vorgesehenen Verwendungszweck in eigener Verantwortung selbst zu prüfen. Dies gilt insbesondere für alle Komponenten, die zusammen mit unserem Produkt verarbeitet werden und deren Verträglichkeit im Verbund. Im Übrigen gelten unsere allgemeinen Geschäftsbedingungen. Hiermit verlieren alle früheren, anderslautenden Regelungen ihre Gültigkeit.

Application / Processing

Suitable for many kinds of upholsteries and coverings in the upholstery industry. Especially suitable for the use in the modern residential and contract area, in public buildings and institutions. Problem-free processing in the usual procedures (sewing, tacking, sticking, nailing). Do not use colored adhesives or solvent adhesives!

Other instructions

To maintain the material properties of your skai® product, it is necessary to regularly clean the material surface. Use a warm, mild soap solution and a microfiber cloth or a soft hand brush for this purpose. Please do not use chemical bleach or abrasive cleaning agents. Please note that staining of the material through jeans or other textiles is excluded from any warranty.

Special notes

Our spoken and written application engineering recommendations, which we pass on based on our experience and in accordance with the current state of the art, are non-binding. They do not absolve buyers of their own responsibility to check the suitability of our products for the intended purpose. This applies in particular to all components that are processed together with our product and their compatibility in combination with each other. Otherwise, our general terms and conditions are in effect. All earlier provisions to the contrary hereby become invalid.

Aplicaciones / Manipulación

Adecuado para numerosos tipos de tapizados y revestimientos en el sector de la tapicería. Especialmente adecuado para su uso en el ámbito residencial exclusivo y de tendencia y en instalaciones y edificios públicos. Aplicación sencilla por medio de procedimientos habituales (cosido, hilvanado, pegado, clavado). ¡No utilizar adhesivos tintados ni a base de disolventes!

Otros consejos

Para conservar las propiedades del material de su producto de skai® es necesario limpiar regularmente la superficie del material. Utilice para ello lejía jabonosa suave y tibia con un paño de microfibra o un cepillo de mano suave. No utilice blanqueadores químicos ni productos de limpieza abrasivos. Tenga en cuenta que las manchas por decoloración en el material causadas por pantalones vaqueros u otros tejidos quedan excluidas de cualquier garantía.

Advertencias especiales

Las recomendaciones de aplicaciones técnicas que ofrecemos, ya sea de palabra o por escrito, en base a nuestra experiencia y conforme a los avances tecnológicos actuales, no son vinculantes. En ningún caso eximirán al comprador de comprobar por sí mismo y bajo su propia responsabilidad la idoneidad de nuestros productos para la finalidad de uso prevista. Esto se aplica especialmente para todos aquellos componentes que se utilicen junto con nuestro producto y su compatibilidad al combinarlos. En todo lo demás, se aplicarán nuestras condiciones generales, lo que supone la nulidad de cualquier otro acuerdo previo.



* nach den gesetzlichen Bestimmungen prescribed by law de conformidad con las disposiciones legales



Continental 
The Future in Motion

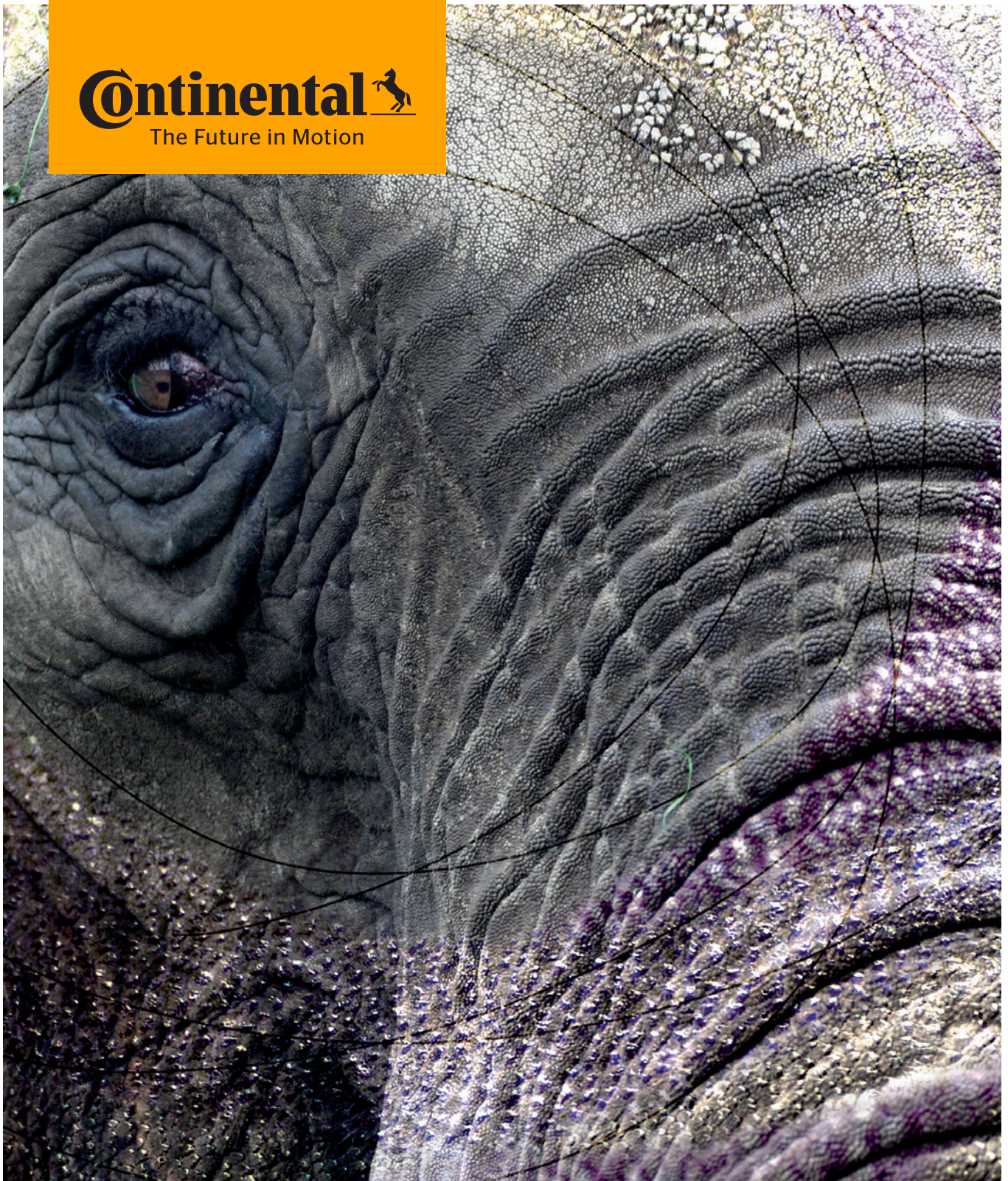

skai® Plata

Leather Design FR

Hochwertiges skai® Material mit fein strukturierter Elefantenledernarbung und feinem Matt-Glanz-Effekt.

High-quality skai® material with fine structured elephant leather grain and fine matte glossy effect.

Un material skai® de alta calidad con el grano estructurado de piel de elefante y un delicado efecto mate-brillo.



skai® Plata atoll F6410933

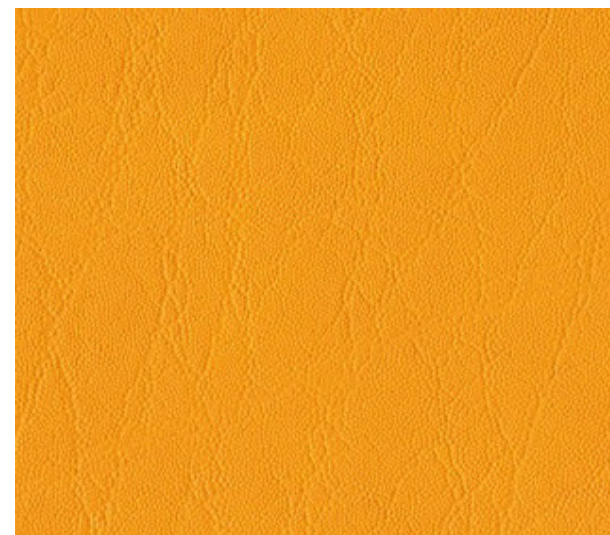

mais F6411004



feuer F6410931



agave F6410878



rodeo F6410779



mohn F6410852



sky F6411020

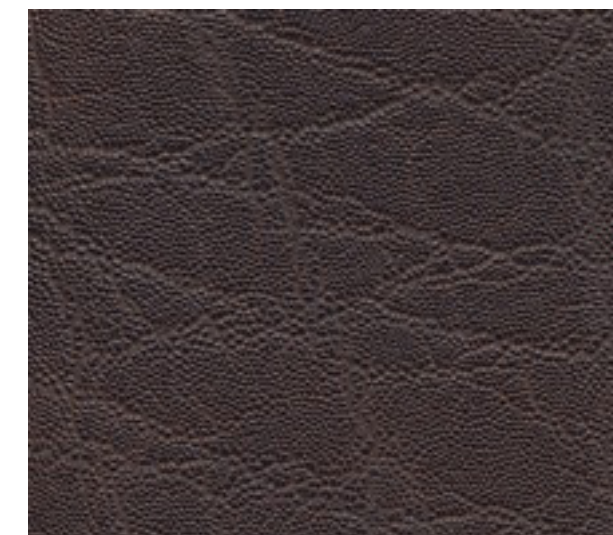

palisander F6410777



schiefer F6410932



nickel F6410851



limone F6411015



granit F6410812

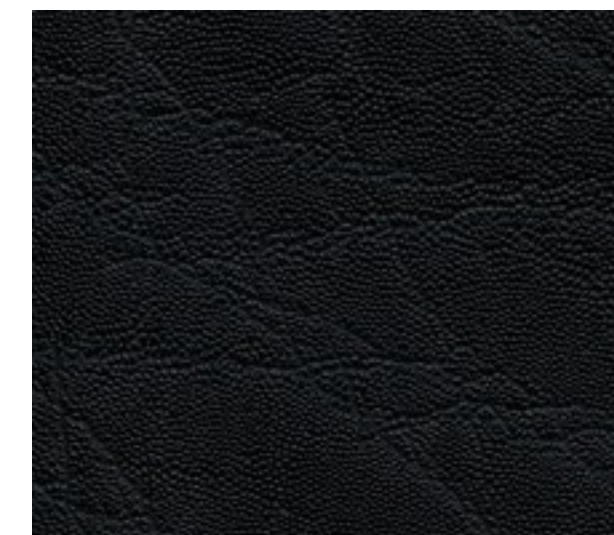

schwarz F6410811



Public Area



Hospitality



Residential



Healthcare



Fitness

Materialzusammensetzung:

ca. 89 % PVC-Compound
ca. 11 % BW/PES-Gestrick
Gewicht: 800 +/- 50 g/m²
Dicke: 1,3 +/- 0,2 mm
Rollenbreite: 137 cm
Rollenlänge: 30m

Material composition:

approx. 89 % PVC-compound
approx. 11 % CO/PES-knitted fabric
Weight: 800 +/- 50 g/m²
Thickness: 1.3 +/- 0.2 mm
Roll width: 137 cm
Roll length: 30m

Composición del material:

aprox. 89 % compuesto de PVC
aprox. 11 % soporte textil de punto de algodón/PES
Peso: 800 +/- 50 g/m²
Espesor: 1,3 +/- 0,2 mm
Ancho de rollo: 137 cm
Largo de rollo: 30 m



langlebig
long-lasting
larga vida útil



reißfest
tear resistant
resistente al desgarro



abriebfest
abrasion resistant
resistencia a la abrasión
DIN EN ISO 5470-2:
≥ 100 000 Martindale
invers/inverse/inverso



schwer entflammbar
flame protection
resistencia al fuego
NF M2, BS 5852 IS-0+1,
DIN EN 1021-1+2,
DIN 4102 (Part 1, B2),
MVSS 302,
UNI 9175/87 (1.IM)



pflegeleicht
easy to clean
fácil mantenimiento



lichtecht
lightfast
resistente a la luz



desinfektionsmittelbeständig
disinfectant resistant
resistente a los
desinfectantes



blut- und urinbeständig
blood- and urine resistant
resistente a la sangre
y a la orina



vegan
vegan
vegano



0161/2023
IMO FTPC 2010 Part 8

Anwendung / Verarbeitung

Geeignet für viele Arten von Bepolsterungen und Bespannungen in der Polsterindustrie. Besonders geeignet für den Einsatz im trendorientierten Wohn- und Objektbereich, in öffentlichen Gebäuden und Einrichtungen. Problemlose Verarbeitung nach den üblichen Verfahren (Nähen, Heften, Kleben, Nageln). Keine eingefärbten Kleber oder Lösemittelkleber verwenden!

Sonstige Hinweise

Zum Erhalt der Materialeigenschaften Ihres skai® Produktes ist eine regelmäßige Reinigung der Materialoberfläche erforderlich. Benutzen Sie hierzu eine warme, milde Seifenlauge und ein Mikrofasertuch oder eine weiche Handbürste. Bitte verwenden Sie keine chemischen Bleichen oder scheuernde Reinigungsmittel. Bitte beachten Sie, dass Anfärbungen des Materials durch Jeans oder andere Textilien von jeglicher Gewährleistung ausgenommen sind.

Besondere Hinweise

Unsere anwendungstechnischen Empfehlungen in Wort und Schrift, die wir aufgrund unserer Erfahrung entsprechend dem aktuellen Stand der Technik weitergeben, sind unverbindlich. Sie entbinden den Käufer nicht davon, die Eignung unsere Produkte für den vorgesehenen Verwendungszweck in eigener Verantwortung selbst zu prüfen. Dies gilt insbesondere für alle Komponenten, die zusammen mit unserem Produkt verarbeitet werden und deren Verträglichkeit im Verbund. Im Übrigen gelten unsere allgemeinen Geschäftsbedingungen. Hiermit verlieren alle früheren, anderslautenden Regelungen ihre Gültigkeit.

Application / Processing

Suitable for many kinds of upholsteries and coverings in the upholstery industry. Especially suitable for the use in the modern residential and contract area, in public buildings and institutions. Problem-free processing in the usual procedures (sewing, tacking, sticking, nailing). Do not use colored adhesives or solvent adhesives!

Other instructions

To maintain the material properties of your skai® product, it is necessary to regularly clean the material surface. Use a warm, mild soap solution and a microfiber cloth or a soft hand brush for this purpose. Please do not use chemical bleach or abrasive cleaning agents. Please note that staining of the material through jeans or other textiles is excluded from any warranty.

Special notes

Our spoken and written application engineering recommendations, which we pass on based on our experience and in accordance with the current state of the art, are non-binding. They do not absolve buyers of their own responsibility to check the suitability of our products for the intended purpose. This applies in particular to all components that are processed together with our product and their compatibility in combination with each other. Otherwise, our general terms and conditions are in effect. All earlier provisions to the contrary hereby become invalid.

Aplicaciones / Manipulación

Apto para múltiples tipos de tapizado y revestimientos para la industria del mueble tapizado. Especialmente diseñado para el empleo en espacios modernos tanto públicos como privados, en edificios públicos e instituciones. Aplicación sencilla por medio de procedimientos habituales (cosido, hilvanado, pegado, clavado). ¡No utilizar adhesivos tintados ni a base de disolventes!

Otros consejos

Para conservar las propiedades del material de su producto de skai® es necesario limpiar regularmente la superficie del material. Utilice para ello lejía jabonosa suave y tibia con un paño de microfibra o un cepillo de mano suave. No utilice blanqueadores químicos ni productos de limpieza abrasivos. Tenga en cuenta que las manchas por decoloración en el material causadas por pantalones vaqueros u otros tejidos quedan excluidas de cualquier garantía.

Advertencias especiales

Las recomendaciones de aplicaciones técnicas que ofrecemos, ya sea de palabra o por escrito, en base a nuestra experiencia y conforme a los avances tecnológicos actuales, no son vinculantes. En ningún caso eximirán al comprador de comprobar por sí mismo y bajo su propia responsabilidad la idoneidad de nuestros productos para la finalidad de uso prevista. Esto se aplica especialmente para todos aquellos componentes que se utilicen junto con nuestro producto y su compatibilidad al combinarlos. En todo lo demás, se aplicarán nuestras condiciones generales, lo que supone la nulidad de cualquier otro acuerdo previo.



* nach den gesetzlichen Bestimmungen prescribed by law de conformidad con las disposiciones legales



Continental 
The Future in Motion



skai® Mailo

Leather Design FR

Polstermaterial mit besonders naturgetreuer Rindslederoptik. Die softe Prägung verleiht dem Material eine angenehme Haptik sowie eine sehr real wirkende Optik. Die Oberfläche bietet in den verschiedensten Farben eine große Vielfalt. Dank flammhemmender Eigenschaften kann skai® Mailo in jedem denkbaren Hospitality-Bereich eingesetzt werden.

Upholstery material with a particularly realistic cowhide look. The soft embossing gives the material a pleasant feel and a very realistic look. The surface offers a wide variety of colors. Thanks to its flame-retardant characteristics, skai® Mailo can be used in any imaginable area of the hospitality industry.

Material de tapizado con una estética de cuero vacuno especialmente realista. Su suave relieve aporta al material una sensación agradable y un aspecto muy natural. La superficie ofrece una gran variedad de colores. Gracias a sus características retardantes de la llama, skai® Mailo puede usarse en cualquier área imaginable del sector hostelero.



skai® Mailo stone F642522

skai® Mailo



white F6425249



ivory F6425250



light beige F6425251



beige F6425248



light stone F6425253



stone F6425252

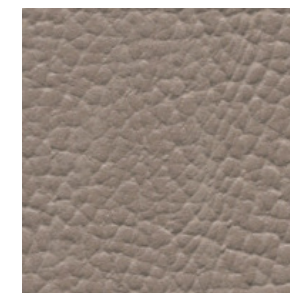

dark stone F6425258

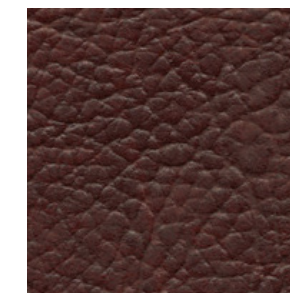

bordeaux F6425234

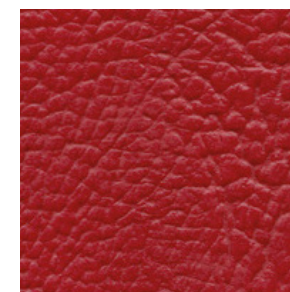

red F6425237



light orange F6425259

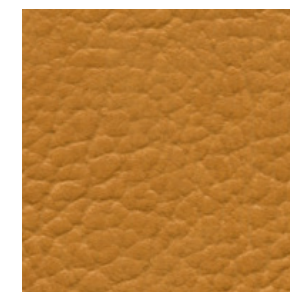

brown 4 F6425247

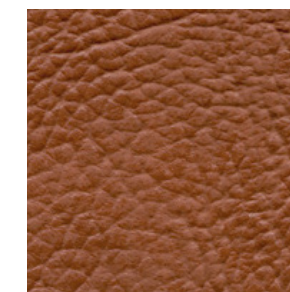

brown 3 F6425244

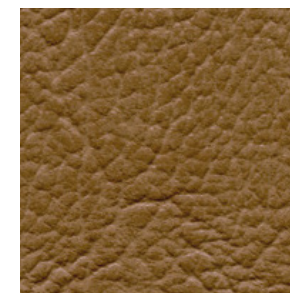

brown 2 F6425246



brown 1 F6425243



wenge F6425245

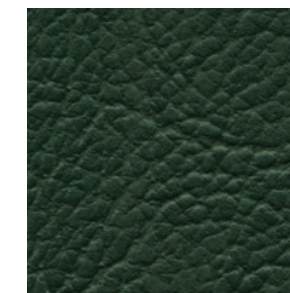

green F6425230

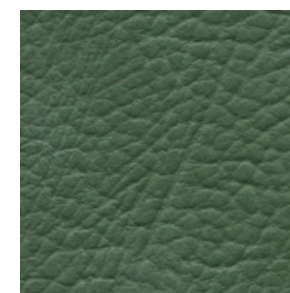

light green F6425231

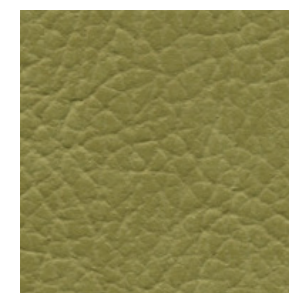

green army F6425233

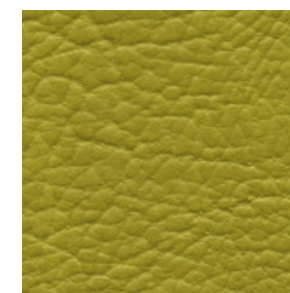

pistache F6425232



sky blue F6425242

skai® Mailo



blue F6425241

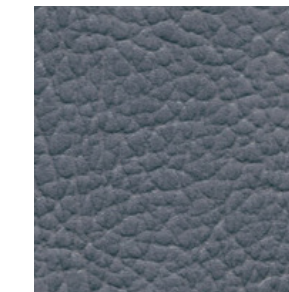

dark blue F6425239

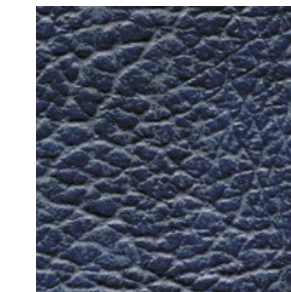

navy F6425240



light grey F6425257

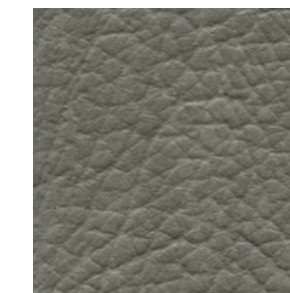

grey F6425255

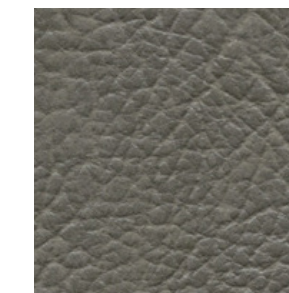

dark grey F6425256



black F6425254



Public Area



Hospitality



Residential



Healthcare

Materialzusammensetzung:

ca. 78% PVC-Compound
ca. 22% Baumwolle
Gewicht: 825 +/- 65 g/m²
Dicke: 1,3 +/- 0,2 mm
Rollenbreite: 140 cm
Rollenlänge: 30 m

Material composition:

approx. 78% PVC-compound
approx. 22% Cotton
Weight: 825 +/- 65 g/m²
Thickness: 1.3 +/- 0.2 mm
Roll width: 140 cm
Roll length: 30 m

Composición del material:

aprox. 78% compuesto de PVC
aprox. 22% Algodón
Peso: 825 +/- 65 g/m²
Espesor: 1,3 +/- 0,2 mm
Ancho de rollo: 140 cm
Largo de rollo: 30 m



lichtecht
lightfast
resistente a la luz
DIN EN ISO 105-B02,
Stufe 6 / level 6 / nivel 6



abriebfest
abrasion resistant
resistencia a la abrasión
DIN EN ISO 5470-2:
≥ 80 000 Martindale
invers/inverse/inverso



lösungsmittelfrei
solvent free
exento de solvente



schwer entflammbar
flame protection
resistencia al fuego
EN 1021 (1-2), M2, B2,
BS 5852 (CRIB 5),
IMO FTPC 2010 Part 8



salzwasserbeständig
salt water resistant
resistente al agua salada
DIN EN ISO 9227



antibakteriell/antimikrobiell
antibacterial/antimicrobial
antibacteriano/antimicrobiana



vegan
vegan
vegano

Anwendung / Verarbeitung

Geeignet für viele Arten von Bepolsterungen und Bespannungen in der Polsterindustrie. Besonders geeignet für den Einsatz im trendorientierten Wohn- und Objektbereich, in öffentlichen Gebäuden und Einrichtungen. Problemlose Verarbeitung nach den üblichen Verfahren (Nähen, Heften, Kleben, Nageln). Keine Lösemittelkleber verwenden!

Sonstige Hinweise

Zum Erhalt der Materialeigenschaften Ihres skai® Produktes ist eine regelmäßige Reinigung der Materialoberfläche erforderlich. Benutzen Sie hierzu eine warme, milde Seifenlauge und ein Mikrofasertuch oder eine weiche Handbürste. Bitte verwenden Sie keine chemischen Bleichen oder scheuernde Reinigungsmittel. Bitte beachten Sie, dass Anfärbungen des Materials durch Jeans oder andere Textilien von jeglicher Gewährleistung ausgenommen sind.

Besondere Hinweise

Unsere anwendungstechnischen Empfehlungen in Wort und Schrift, die wir aufgrund unserer Erfahrung entsprechend dem aktuellen Kenntnisstand weitergeben, sind unverbindlich und begründen kein Rechtsverhältnis und keine Nebenverpflichtungen aus dem Kaufvertrag. Sie entbinden den Käufer nicht davon, unsere Produkte für den vorgesehenen Verwendungszweck in eigener Verantwortung selbst zu prüfen. Im Übrigen gelten unsere allgemeinen Geschäftsbedingungen. Hiermit verlieren alle früheren, anderslautenden Regelungen ihre Gültigkeit.

Application / Processing

Suitable for many kinds of upholsteries and coverings in the upholstery industry. Especially suitable for the use in the modern residential and contract area, in public buildings and institutions. Problem-free processing in the usual procedures (sewing, tacking, sticking, nailing). Do not use solvent-based adhesives!

Other instructions

To maintain the material properties of your skai® product, it is necessary to regularly clean the material surface. Use a warm, mild soap solution and a microfiber cloth or a soft hand brush for this purpose. Please do not use chemical bleach or abrasive cleaning agents. Please note that staining of the material through jeans or other textiles is excluded from any warranty.

Special notes

Our written and spoken technical recommendations, which we provide based on our experience in accordance with the current state of knowledge, are nonbinding and do not constitute a legal relationship and are not additional obligations from the purchase agreement. They do not release the purchaser from checking our products for the intended use under his own responsibility. Otherwise, our general terms and conditions are in effect. All earlier provisions to the contrary hereby become invalid.

Aplicaciones / Manipulación

Apto para múltiples tipos de tapizado y revestimientos para la industria del mueble tapizado. Especialmente diseñado para el empleo en espacios modernos tanto públicos como privados, en edificios públicos e instituciones. Aplicación sencilla por medio de procedimientos habituales (cosido, hilvanado, pegado, clavado). No usar pegamento disolvente.

Otros consejos

Para conservar las propiedades del material de su producto de skai® es necesario limpiar regularmente la superficie del material. Utilice para ello lejía jabonosa suave y tibia con un paño de microfibra o un cepillo de mano suave. No utilice blanqueadores químicos ni productos de limpieza abrasivos. Tenga en cuenta que las manchas por decoloración en el material causadas por pantalones vaqueros u otros tejidos quedan excluidas de cualquier garantía.

Advertencias especiales

Nuestras recomendaciones técnicas de aplicación, verbales o escritas, que facilitemos sobre la base de nuestra experiencia y de los conocimientos técnicos más actuales, no son vinculantes en ningún caso ni constituyen un compromiso contractual o responsabilidades añadidas al contrato de compraventa. No eximen al comprador de verificar personalmente nuestros productos para el uso previsto y bajo su responsabilidad. En todo lo demás, se aplicarán nuestras condiciones generales, lo que supone la nulidad de cualquier otro acuerdo previo.



* nach den gesetzlichen Bestimmungen prescribed by law de conformidad con las disposiciones legales

REACH

DIN EN ISO 14001
DIN EN ISO 45001
DIN EN ISO 9001
IATF 16949

Continental 
The Future in Motion



skai® Palma
Leather Design FR

Hochwertiges skai® Material mit feiner Kalbsledernarbung und einem dezenten Druckbild. Das Material ist universell einsetzbar und insbesondere für den Objektbereich, für öffentliche Gebäude und Einrichtungen geeignet.

High-quality skai® material with a fine-structured calf leather grain and a subdued printing. The material is all-purpose and especially suitable for the contract area, for public buildings and institutions.

Un material skai® de alta calidad con grano fino de cuero vacuno y un discreto motivo impreso. Este material admite un uso universal, en especial en el ámbito de la decoración y en instalaciones y edificios públicos.



skai® Palma limone F6411172

skai® Palma

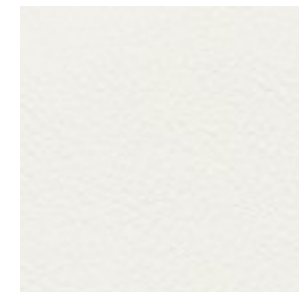

weiss F6410907

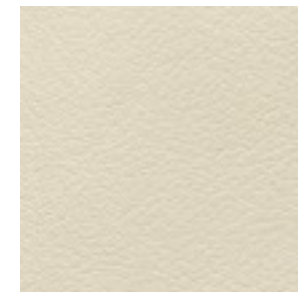

perle F6410702

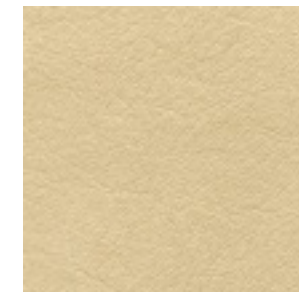

gobi F6410703

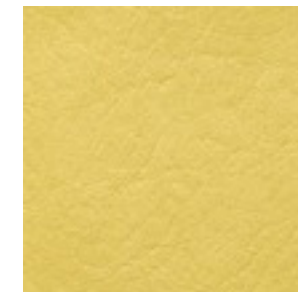

mimosa F6410983

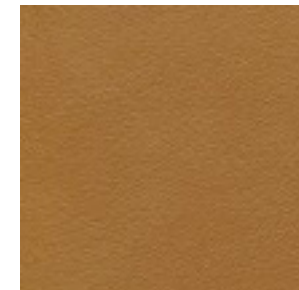

kaschmir F6410709

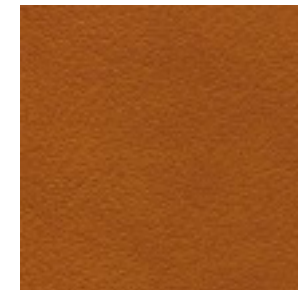

lima F6410710

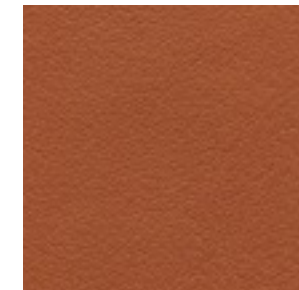

whisky F6410929

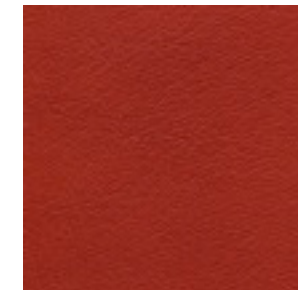

lachs F6410711

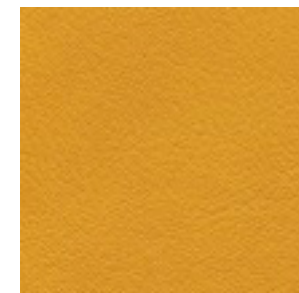

mango F6411060

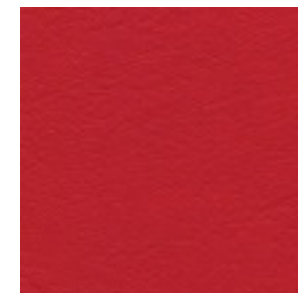

feuer F6410994

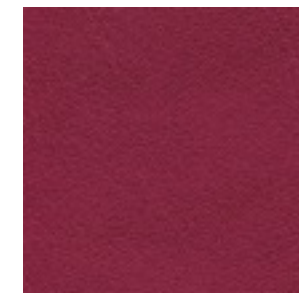

rubin F6410927

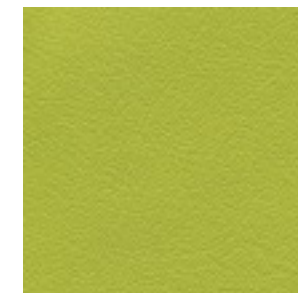

limone F6411172

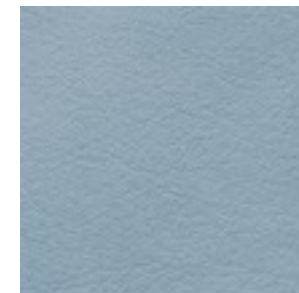

rauchblau F6411059



sky F6411053

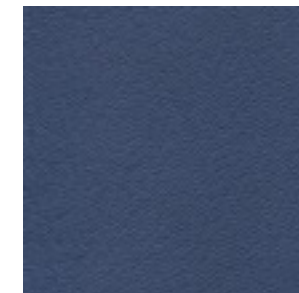

baltic F6410714

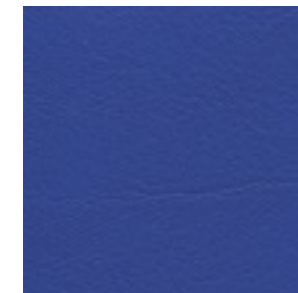

atoll F6410925



silbergrey F6411061



platin F6410713



anthrazit F6411062

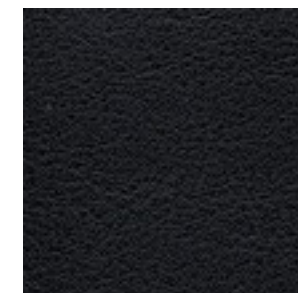

schwarz F6410701

skai® Palma

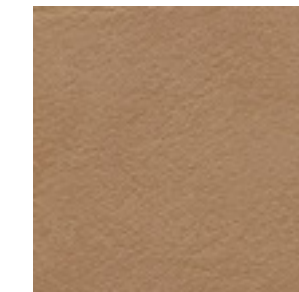

torf F6410705

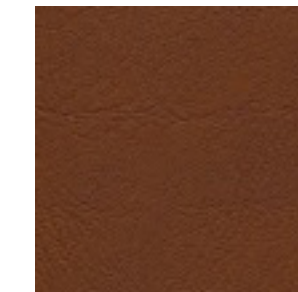

inka F6410706

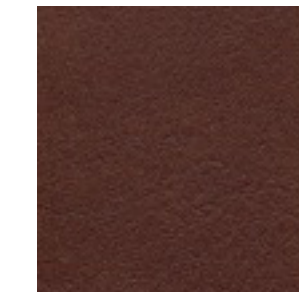

niger F6410707

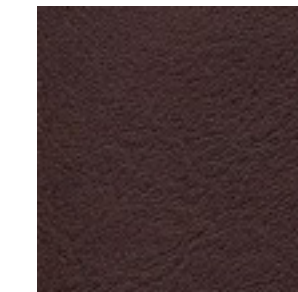

kenia F6410708



birke F6411169

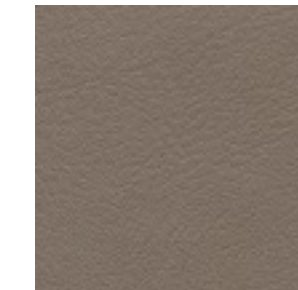

fango F6411170

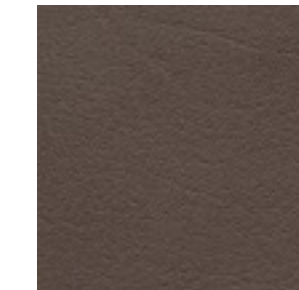

olivbraun F6411171

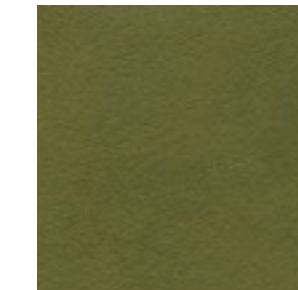

taiga F6410715



amazonas F6410926

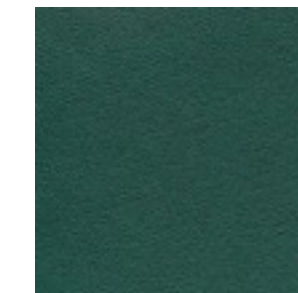

tundra F6410716



Public Area



Hospitality



Residential



Healthcare

Materialzusammensetzung:

ca. 89 % PVC-Compound
ca. 11 % BW/PES-Gestrick
Gewicht: 825 +/- 50 g/m²
Dicke: 1,3 +/- 0,2 mm
Rollenbreite: 137 cm
Rollenlänge: 30m

Material composition:

approx. 89 % PVC-compound
approx. 11 % CO/PES-knitted fabric
Weight: 825 +/- 50 g/m²
Thickness: 1.3 +/- 0.2 mm
Roll width: 137 cm
Roll length: 30m

Composición del material:

aprox. 89 % compuesto de PVC
aprox. 11 % soporte textil de punto de algodón/PES
Peso: 825 +/- 50 g/m²
Espesor: 1,3 +/- 0,2 mm
Ancho de rollo: 137 cm
Largo de rollo: 30 m



langlebig
long-lasting
larga vida útil



reißfest
tear resistant
resistente al desgarro



abriebfest
abrasion resistant
resistencia a la abrasión
DIN EN ISO 5470-2:
≥ 100 000 Martindale
invers/inverse/inverso



schwer entflammbar
flame protection
resistencia al fuego
DIN 4102 (Part 1, B2),
NF M2, BS5852 IS-0+1,
DIN EN 1021-1+2, MVSS 302,
FAR 25.853,
UNI 9175/87 (1.IM)



pflegeleicht
easy to clean
fácil mantenimiento



lichtecht
lightfast
resistente a la luz



desinfektionsmittelbeständig
disinfectant resistant
resistente a los
desinfectantes



blut- und urinbeständig
blood- and urine resistant
resistente a la sangre
y a la orina



vegan
vegan
vegano



0161/2023
IMO FTPC 2010 Part 8

Anwendung / Verarbeitung

Geeignet für viele Arten von Bepolsterungen und Spannungen in der Polsterindustrie. Besonders geeignet für den Einsatz im trendorientierten Wohn- und Objektbereich, in öffentlichen Gebäuden und Einrichtungen. Problemlose Verarbeitung nach den üblichen Verfahren (Nähen, Heften, Kleben, Nageln). Keine eingefärbten Kleber oder Lösemittelkleber verwenden!

Application / Processing

Suitable for many kinds of upholsteries and coverings in the upholstery industry. Especially suitable for the use in the modern residential and contract area, in public buildings and institutions. Problem-free processing in the usual procedures (sewing, tacking, sticking, nailing). Do not use colored adhesives or solvent adhesives!

Aplicaciones / Manipulación

Apto para múltiples tipos de tapizado y revestimientos para la industria del mueble tapizado. Especialmente diseñado para el empleo en espacios modernos tanto públicos como privados, en edificios públicos e instituciones. Aplicación sencilla por medio de procedimientos habituales (cosido, hilvanado, pegado, clavado). ¡No utilizar adhesivos tintados ni a base de disolventes!

Sonstige Hinweise

Zum Erhalt der Materialeigenschaften Ihres skai® Produktes ist eine regelmäßige Reinigung der Materialoberfläche erforderlich. Benutzen Sie hierzu eine warme, milde Seifenlauge und ein Mikrofaser Tuch oder eine weiche Handbürste. Bitte verwenden Sie keine chemischen Bleichen oder scheuernde Reinigungsmittel. Bitte beachten Sie, dass Anfärbungen des Materials durch Jeans oder andere Textilien von jeglicher Gewährleistung ausgenommen sind.

Other instructions

To maintain the material properties of your skai® product, it is necessary to regularly clean the material surface. Use a warm, mild soap solution and a microfiber cloth or a soft hand brush for this purpose. Please do not use chemical bleach or abrasive cleaning agents. Please note that staining of the material through jeans or other textiles is excluded from any warranty.

Otros consejos

Para conservar las propiedades del material de su producto de skai® es necesario limpiar regularmente la superficie del material. Utilice para ello lejía jabonosa suave y tibia con un paño de microfibra o un cepillo de mano suave. No utilice blanqueadores químicos ni productos de limpieza abrasivos. Tenga en cuenta que las manchas por decoloración en el material causadas por pantalones vaqueros u otros tejidos quedan excluidas de cualquier garantía.

Besondere Hinweise

Unsere anwendungstechnischen Empfehlungen in Wort und Schrift, die wir aufgrund unserer Erfahrung entsprechend dem aktuellen Stand der Technik weitergeben, sind unverbindlich. Sie entbinden den Käufer nicht davon, die Eignung unsere Produkte für den vorgesehenen Verwendungszweck in eigener Verantwortung selbst zu prüfen. Dies gilt insbesondere für alle Komponenten, die zusammen mit unserem Produkt verarbeitet werden und deren Verträglichkeit im Verbund. Im Übrigen gelten unsere allgemeinen Geschäftsbedingungen. Hiermit verlieren alle früheren, anderslautenden Regelungen ihre Gültigkeit.

Special notes

Our spoken and written application engineering recommendations, which we pass on based on our experience and in accordance with the current state of the art, are non-binding. They do not absolve buyers of their own responsibility to check the suitability of our products for the intended purpose. This applies in particular to all components that are processed together with our product and their compatibility in combination with each other. Otherwise, our general terms and conditions are in effect. All earlier provisions to the contrary hereby become invalid.

Advertencias especiales

Las recomendaciones de aplicaciones técnicas que ofrecemos, ya sea de palabra o por escrito, en base a nuestra experiencia y conforme a los avances tecnológicos actuales, no son vinculantes. En ningún caso eximirán al comprador de comprobar por sí mismo y bajo su propia responsabilidad la idoneidad de nuestros productos para la finalidad de uso prevista. Esto se aplica especialmente para todos aquellos componentes que se utilicen junto con nuestro producto y su compatibilidad al combinarlos. En todo lo demás, se aplicarán nuestras condiciones generales, lo que supone la nulidad de cualquier otro acuerdo previo.



* nach den gesetzlichen Bestimmungen prescribed by law de conformidad con las disposiciones legales



Continental 
The Future in Motion



skai® Gemini
Leather Design FR



Gemini



Der Polsterbezugstoff zeichnet sich durch eine besonders feine Ledernarbung aus. Die große Farbpalette, flammhemmende Eigenschaften und seine angenehme, natürliche Haptik machen das Material perfekt für den Einsatz im Hospitality-Bereich, wie Hotels, öffentliche Einrichtungen oder Kreuzfahrtschiffe.

The upholstery material is characterized by a very fine leather grain. Due to its large color pallet, flame-retardant characteristics, and its pleasant, natural feel, the material is perfectly suited for use in the hospitality industry, such as hotels, public institutions, or cruise ships.

Este material de tapizado se caracteriza por un grano cuero muy fino. Gracias a su gran paleta de colores, sus características retardantes de la llama y su sensación agradable y natural, resulta idóneo para su uso en el sector hostelero, por ejemplo, en hoteles, instituciones públicas o cruceros.

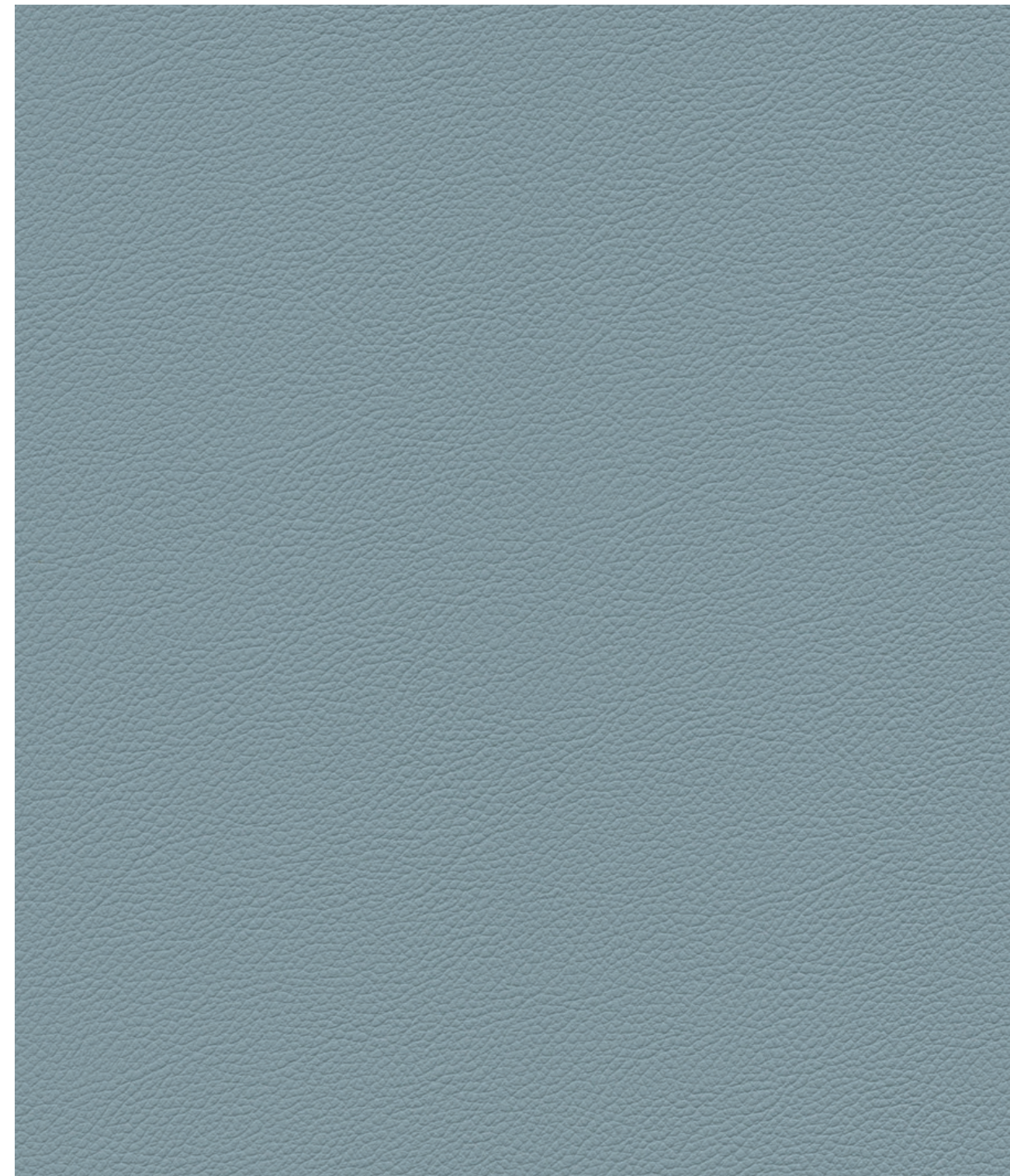

skai® Gemini blue fog F6425160

skai® Gemini



beige F6425147	sand F6425146	toasted nut F6425155	orange F6425134
perle F6425156	cappuccino F6425157	light orange F6425153	brown F6425143
yellow F6425152	light green F6425133	green F6425131	dark green F6425132
light stone F6425148	stone F6425151	dark stone F6425144	wenge F6425142
ashgrey F6425158	platinum F6425159	grey F6425149	black F6425150

skai® Gemini



blue fog F6425160	blue-grey F6425141	dark blue F6425138	navy F6425139
fuchsia F6425137	purple F6425154	blue F6425140	health green F6425130
red F6425135	bordeaux F6425136	marsala F6425161	powder rosé F6425162
white F6425145			

skai® Surfaces Protective Finish

Protective finish
Advanced technology that protects the article against the stains, making it easier to clean and maintaining the initial appearance for longer (slower aging).

Antifungal and antibacteria treatment

PVC Layer

Textile support

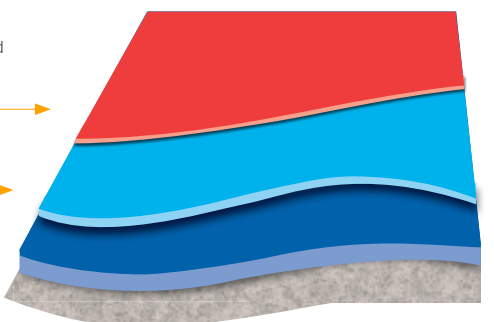



Public Area



Hospitality



Residential



Healthcare



Fitness

Materialzusammensetzung:

ca. 81% PVC-Compound
ca. 19% Polyester
Gewicht: 655 +/- 85 g/m²
Dicke: 1,1 +/- 0,2 mm
Rollenbreite: 140 cm
Rollenlänge: 30 m

Material composition:

approx. 81% PVC-compound
approx. 19% Polyester
Weight: 655 +/- 85 g/m²
Thickness: 1.1 +/- 0.2 mm
Roll width: 140 cm
Roll length: 30 m

Composición del material:

aprox. 81% compuesto de PVC
aprox. 19% Poliéster
Peso: 655 +/- 85 g/m²
Espesor: 1,1 +/- 0,2 mm
Ancho de rollo: 140 cm
Largo de rollo: 30 m



lichtecht
lightfast
resistente a la luz
DIN EN ISO 105-B02,
Stufe 6 / level 6 / nivel 6



abriebfest
abrasion resistant
resistencia a la abrasión
DIN EN ISO 5470-2:
≥ 300 000* Martindale
invers/inverse/inverso
*** DIN EN ISO 5470-1**



lösungsmittelfrei
solvent free
exento de solvente



schwer entflammbar
flame protection
resistencia al fuego
EN 1021 (1-2), M2, B2,
CTB 117, FAR 25853, R118,
IMO FTPC 2010 Part 8



salzwasserbeständig
salt water resistant
resistente al agua salada
DIN EN ISO 9227



antibakteriell/antimikrobiell
antibacterial/antimicrobial
antibacteriano/antimicrobiana



schweiß-, urin- und blutbeständig
resistant to sudor, blood and urine
resistente al sudor, la orina y la sangre



vegan
vegan
vegan

Anwendung / Verarbeitung

Geeignet für viele Arten von Bepolsterungen und Bespannungen in der Polsterindustrie. Besonders geeignet für den Einsatz im trendorientierten Wohn- und Objektbereich, in öffentlichen Gebäuden und Einrichtungen. Problemlose Verarbeitung nach den üblichen Verfahren (Nähen, Heften, Kleben, Nageln). Keine Lösemittelkleber verwenden!

Sonstige Hinweise

Zum Erhalt der Materialeigenschaften Ihres skai® Produktes ist eine regelmäßige Reinigung der Materialoberfläche erforderlich. Benutzen Sie hierzu den skai® Reiniger oder eine warme, milde Seifenlauge und ein Mikrofaser Tuch. Bitte verwenden Sie keine chemischen Bleichen oder scheuernde Reinigungsmittel. Bitte beachten Sie, dass Anfärbungen des Materials durch Jeans oder andere Textilien von jeglicher Gewährleistung ausgenommen sind.

Besondere Hinweise

Unsere anwendungstechnischen Empfehlungen in Wort und Schrift, die wir aufgrund unserer Erfahrung entsprechend dem aktuellen Kenntnisstand weitergeben, sind unverbindlich und begründen kein Rechtsverhältnis und keine Nebenverpflichtungen aus dem Kaufvertrag. Sie entbinden den Käufer nicht davon, unsere Produkte für den vorgesehenen Verwendungszweck in eigener Verantwortung selbst zu prüfen. Im Übrigen gelten unsere allgemeinen Geschäftsbedingungen. Hiermit verlieren alle früheren, anderslautenden Regelungen ihre Gültigkeit.

Application / Processing

Suitable for many kinds of upholsteries and coverings in the upholstery industry. Especially suitable for the use in the modern residential and contract area, in public buildings and institutions. Problem-free processing in the usual procedures (sewing, tacking, sticking, nailing). Do not use solvent-based adhesives!

Other instructions

To maintain the material properties of your skai® product, it is necessary to regularly clean the material surface. For cleaning, please use skai® cleaning agent or a warm, mild soapy water and a microfiber cloth. Please do not use chemical bleach or abrasive cleaning agents. Please note that staining of the material through jeans or other textiles is excluded from any warranty.

Special notes

Our written and spoken technical recommendations, which we provide based on our experience in accordance with the current state of knowledge, are nonbinding and do not constitute a legal relationship and are not additional obligations from the purchase agreement. They do not release the purchaser from checking our products for the intended use under his own responsibility. Otherwise, our general terms and conditions are in effect. All earlier provisions to the contrary hereby become invalid.

Aplicaciones / Manipulación

Apto para múltiples tipos de tapizado y revestimientos para la industria del mueble tapizado. Especialmente diseñado para el empleo en espacios modernos tanto públicos como privados, en edificios públicos e instituciones. Aplicación sencilla por medio de procedimientos habituales (cosido, hilvanado, pegado, clavado). No usar pegamento disolvente.

Otros consejos

Para conservar las propiedades del material de su producto de skai® es necesario limpiar regularmente la superficie del material. Para ello, utilice skai® limpiador o agua jabonosa caliente y suave y un paño de microfibra. No utilice blanqueadores químicos ni productos de limpieza abrasivos. Tenga en cuenta que las manchas por decoloración en el material causadas por pantalones vaqueros u otros tejidos quedan excluidas de cualquier garantía.

Advertencias especiales

Nuestras recomendaciones técnicas de aplicación, verbales o escritas, que facilitemos sobre la base de nuestra experiencia y de los conocimientos técnicos más actuales, no son vinculantes en ningún caso ni constituyen un compromiso contractual o responsabilidades añadidas al contrato de compraventa. No eximien al comprador de verificar personalmente nuestros productos para el uso previsto y bajo su responsabilidad. En todo lo demás, se aplicarán nuestras condiciones generales, lo que supone la nulidad de cualquier otro acuerdo previo.



* nach den gesetzlichen Bestimmungen prescribed by law de conformidad con las disposiciones legales

REACH

DIN EN ISO 14001
DIN EN ISO 45001
DIN EN ISO 9001
IATF 16949

Continental 
The Future in Motion



skai® Gavino
Leather Design FR

Hochwertiger Polsterbezugstoff mit klassischer Ledernarbung. Dank seiner natürlichen Prägung wirkt das Material wie Echtleder. Der einzigartige Druck verleiht dem Material Lebendigkeit. Die vielfältige Farbpalette und flammhemmende Eigenschaften machen skai® Gavino perfekt für den Einsatz im Hospitality-Bereich.

High-quality upholstery material with classic leather grain. Thanks to its natural embossing, the material looks like genuine leather. The unique print gives the material vitality. Due to its diverse color palette and flame-retardant properties, skai® Gavino is perfectly suited for use in the hospitality industry.

Material de tapizado de alta calidad con grano de cuero clásico. Gracias a su relieve natural, el material ofrece las sensaciones del cuero auténtico. Su estampado único aporta vitalidad a este material. Gracias a su paleta de colores diversa y sus propiedades retardantes de la flama, skai® Gavino es ideal para su uso en el sector hostelero.



skai® Gavino grey F6425015

skai® Gavino



white F6425010



beige F6425011



sand F6425012



light brown F6425008

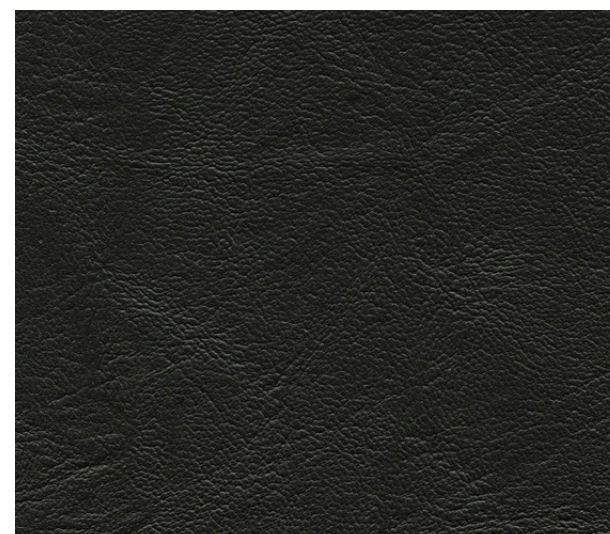

black F6425013

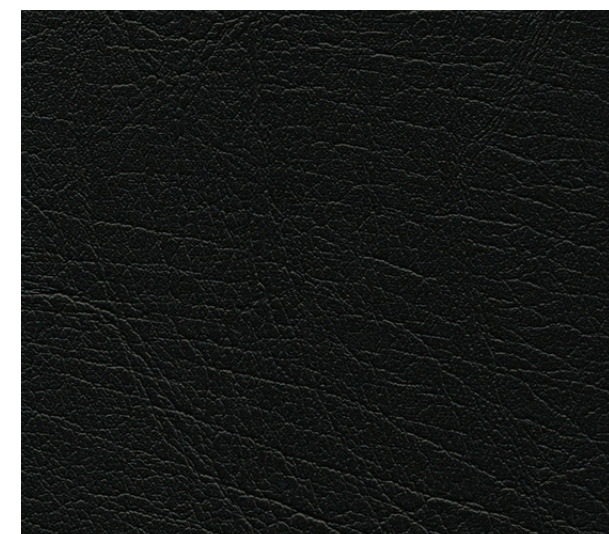

black shine F6425014

skai® Gavino



brown F6425007

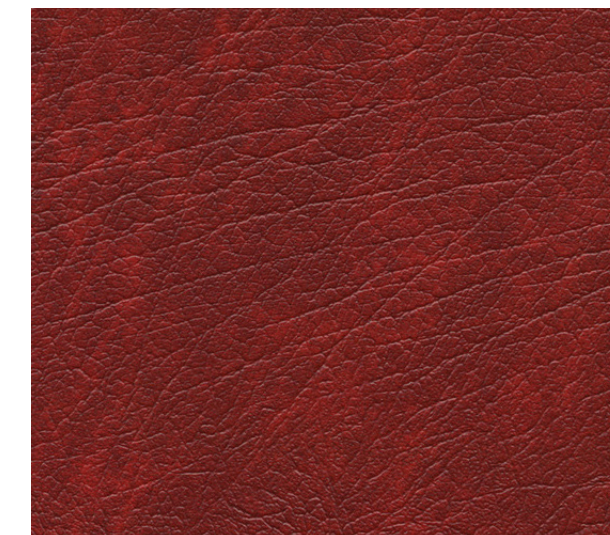

bordeaux F6425003

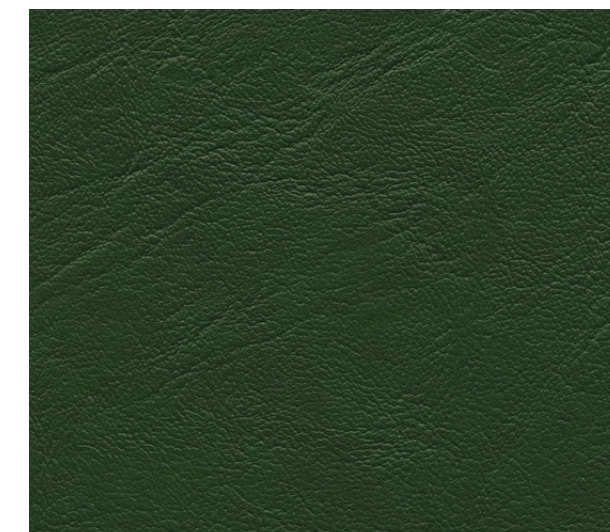

green F6425017



Public Area



Hospitality



Residential



Healthcare



Fitness

Materialzusammensetzung:

ca. 90% PVC-Compound
ca. 10% Baumwolle
Gewicht: 735 +/- 65 g/m²
Dicke: 1,2 +/- 0,2 mm
Rollenbreite: 140 cm
Rollenlänge: 30 m

Material composition:

approx. 90% PVC-compound
approx. 10% Cotton
Weight: 735 +/- 65 g/m²
Thickness: 1.2 +/- 0.2 mm
Roll width: 140 cm
Roll length: 30 m

Composición del material:

aprox. 90% compuesto de PVC
aprox. 10% Algodón
Peso: 735 +/- 65 g/m²
Espesor: 1,2 +/- 0,2 mm
Ancho de rollo: 140 cm
Largo de rollo: 30 m



atmungsaktiv
breathable
transpirable



lichtecht
lightfast
resistente a la luz
DIN EN ISO 105-B02,
Stufe 6 / level 6 / nivel 6



abriebfest
abrasion resistant
resistencia a la abrasión
DIN EN ISO 5470-2:
≥ 160 000 Martindale
invers/inverse/inverso



schwer entflammbar
flame protection
resistencia al fuego
EN 1021 (1-2), M2, B2,
BS 5852 (CRIB 5),
IMO FTPC 2010 Part 8



lösungsmittelfrei
solvent free
exento de solvente



salzwasserbeständig
salt water resistant
resistente al agua salada
DIN EN ISO 9227



antibakteriell/antimikrobiell
antibacterial/antimicrobial
antibacteriano/antimicrobiana



vegan
vegan
vegano

Anwendung / Verarbeitung

Geeignet für viele Arten von Bepolsterungen und Bespannungen in der Polsterindustrie. Besonders geeignet für den Einsatz im trendorientierten Wohn- und Objektbereich, in öffentlichen Gebäuden und Einrichtungen. Problemlose Verarbeitung nach den üblichen Verfahren (Nähen, Heften, Kleben, Nageln). Keine Lösemittelkleber verwenden!

Sonstige Hinweise

Zum Erhalt der Materialeigenschaften Ihres skai® Produktes ist eine regelmäßige Reinigung der Materialoberfläche erforderlich. For cleaning, please use skai® cleaning agent or a warm, mild soapy water and a microfiber cloth. Bitte verwenden Sie keine chemischen Bleichen oder scheuernde Reinigungsmittel. Bitte beachten Sie, dass Anfärbungen des Materials durch Jeans oder andere Textilien von jeglicher Gewährleistung ausgenommen sind.

Besondere Hinweise

Unsere anwendungstechnischen Empfehlungen in Wort und Schrift, die wir aufgrund unserer Erfahrung entsprechend dem aktuellen Kenntnisstand weitergeben, sind unverbindlich und begründen kein Rechtsverhältnis und keine Nebenverpflichtungen aus dem Kaufvertrag. Sie entbinden den Käufer nicht davon, unsere Produkte für den vorgesehenen Verwendungszweck in eigener Verantwortung selbst zu prüfen. Im Übrigen gelten unsere allgemeinen Geschäftsbedingungen. Hiermit verlieren alle früheren, anderslautenden Regelungen ihre Gültigkeit.

Application / Processing

Suitable for many kinds of upholsterys and coverings in the upholstery industry. Especially suitable for the use in the modern residential and contract area, in public buildings and institutions. Problem-free processing in the usual procedures (sewing, tacking, sticking, nailing). Do not use solvent-based adhesives!

Other instructions

To maintain the material properties of your skai® product, it is necessary to regularly clean the material surface. For cleaning, please use skai® cleaning agent or a warm, mild soapy water and a microfiber cloth. Please do not use chemical bleach or abrasive cleaning agents. Please note that staining of the material through jeans or other textiles is excluded from any warranty.

Special notes

Our written and spoken technical recommendations, which we provide based on our experience in accordance with the current state of knowledge, are nonbinding and do not constitute a legal relationship and are not additional obligations from the purchase agreement. They do not release the purchaser from checking our products for the intended use under his own responsibility. Otherwise, our general terms and conditions are in effect. All earlier provisions to the contrary hereby become invalid.

Aplicaciones / Manipulación

Apto para múltiples tipos de tapizado y revestimientos para la industria del mueble tapizado. Especialmente diseñado para el empleo en espacios modernos tanto públicos como privados, en edificios públicos e instituciones. Aplicación sencilla por medio de procedimientos habituales (cosido, hilvanado, pegado, clavado). No usar pegamento disolvente.

Otros consejos

Para conservar las propiedades del material de su producto de skai® es necesario limpiar regularmente la superficie del material. Para ello, utilice skai® limpiador o agua jabonosa caliente y suave y un paño de microfibra. No utilice blanqueadores químicos ni productos de limpieza abrasivos. Tenga en cuenta que las manchas por decoloración en el material causadas por pantalones vaqueros u otros tejidos quedan excluidas de cualquier garantía.

Advertencias especiales

Nuestras recomendaciones técnicas de aplicación, verbales o escritas, que facilitemos sobre la base de nuestra experiencia y de los conocimientos técnicos más actuales, no son vinculantes en ningún caso ni constituyen un compromiso contractual o responsabilidades añadidas al contrato de compraventa. No eximen al comprador de verificar personalmente nuestros productos para el uso previsto y bajo su responsabilidad. En todo lo demás, se aplicarán nuestras condiciones generales, lo que supone la nulidad de cualquier otro acuerdo previo.



* nach den gesetzlichen Bestimmungen prescribed by law de conformidad con las disposiciones legales



DIN EN ISO 14001
DIN EN ISO 45001
DIN EN ISO 9001
IATF 16949



Textile Design

Continental 
The Future in Motion

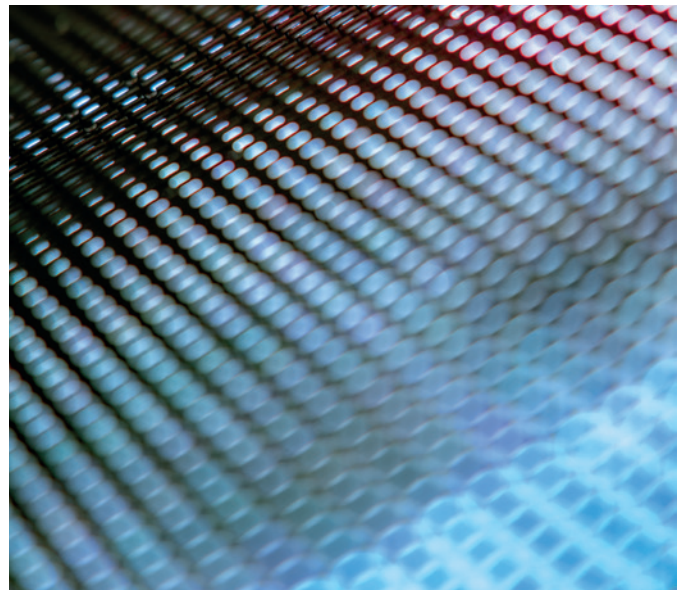
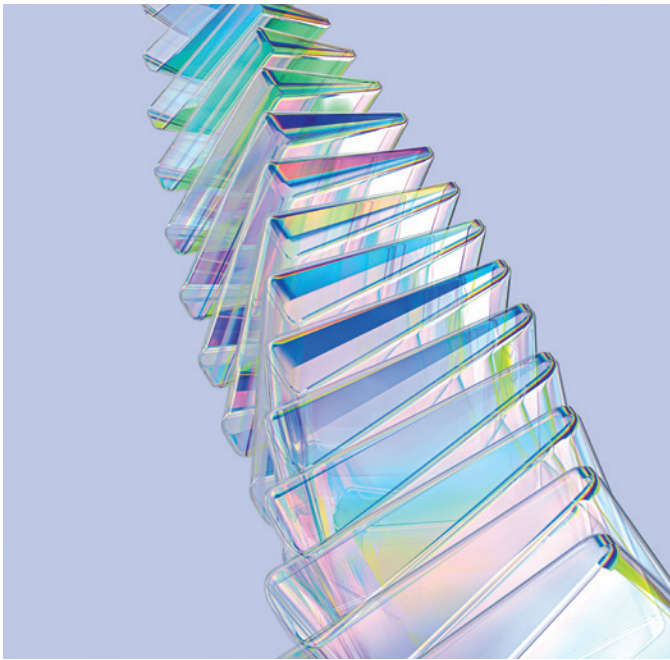

skai® Totexo EN
Textile Design



Totexo EN



Willkommen in der Zukunft - die Textilarbe von skai® Totexo EN sorgt mit ihrem faszinierenden Matt-Glanz-Effekt für einen eleganten Look mit technisch-futuristischem Appeal. Die Farbpalette zeigt sich passend dazu elektrisierend und spacig - perfekt, um einen Hauch von morgen in die Raumgestaltung von heute zu bringen.

Welcome to the future - with its fascinating matt-gloss effect, the textile grain of skai® Totexo EN creates an elegant look with a techno-futuristic appeal. Accordingly the color range is electrifying and spacey - perfect for bringing a touch of tomorrow into today's interior design.

Bienvenidos al futuro: la estructura textil de skai® Totexo EN proporciona un aspecto elegante con un atractivo técnico-futurista gracias a su fascinante efecto mate-brillante. La gama de colores es electrizante y espacial, perfecta para aportar un toque futurista al diseño actual de interiores.



skai® Totexo EN nordic green F6470113

skai® Totexo EN



skai® Totexo EN



brilliant white F6470110

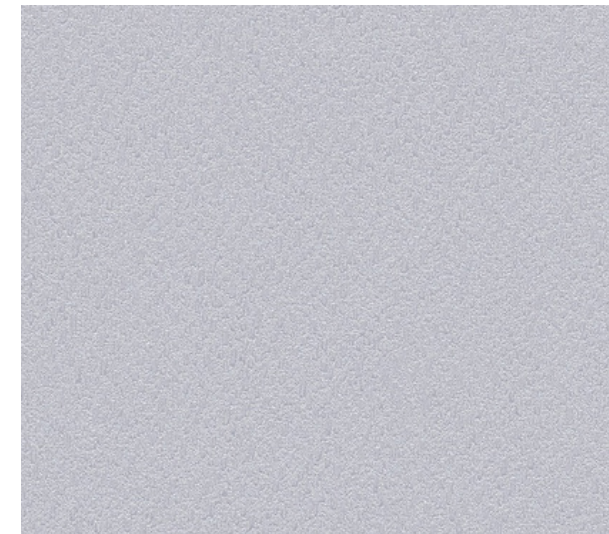

arctic pearl F6470111

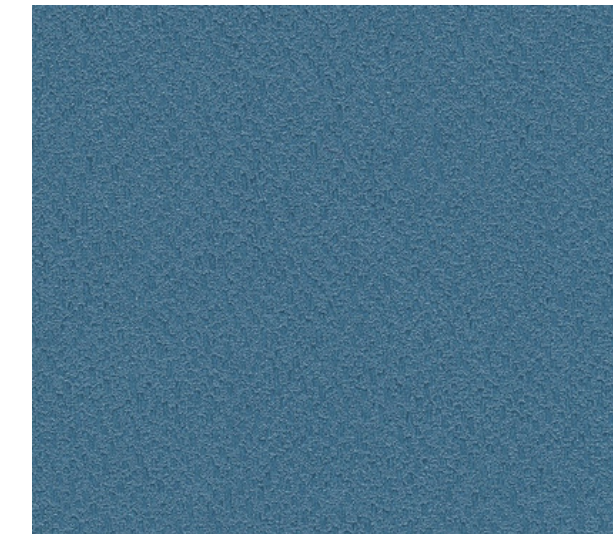

cosmic blue F6470114

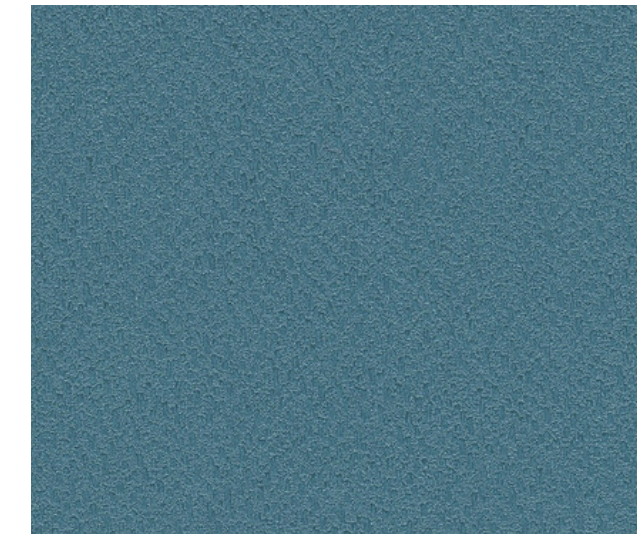

electric blue F6470115

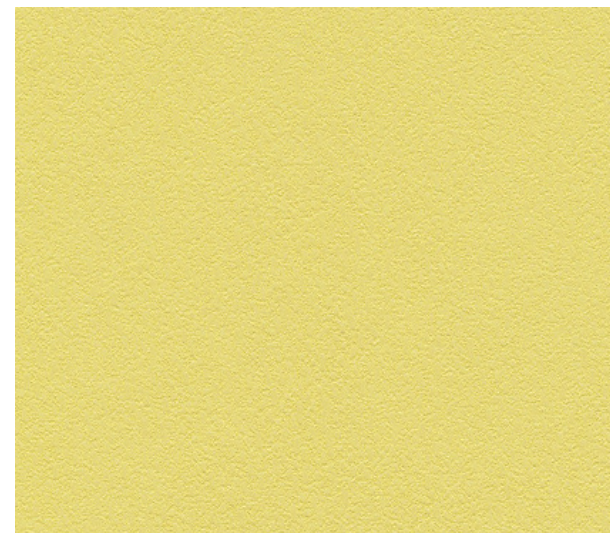

shiny star F6470118

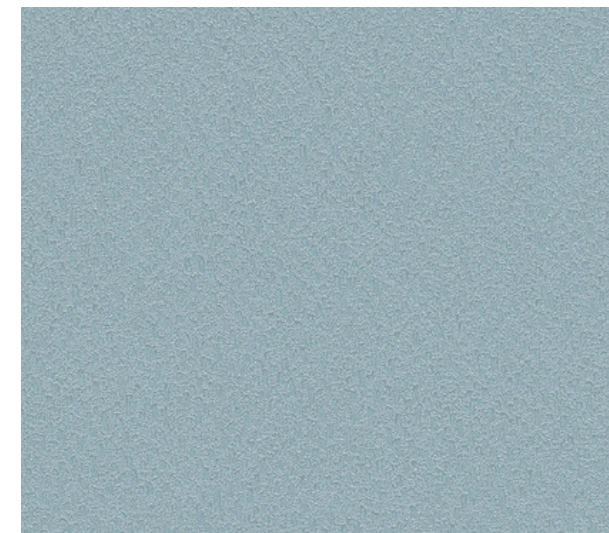

nordic green F6470113

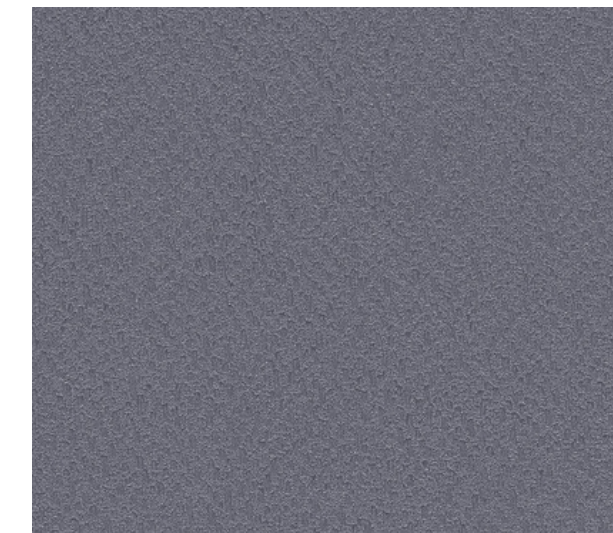

purple fantasy F6470117

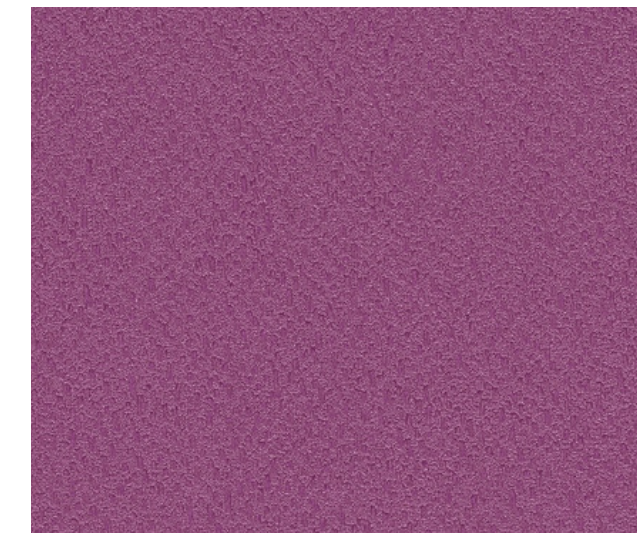

virtual wonder F6470116



nebula green F6470119

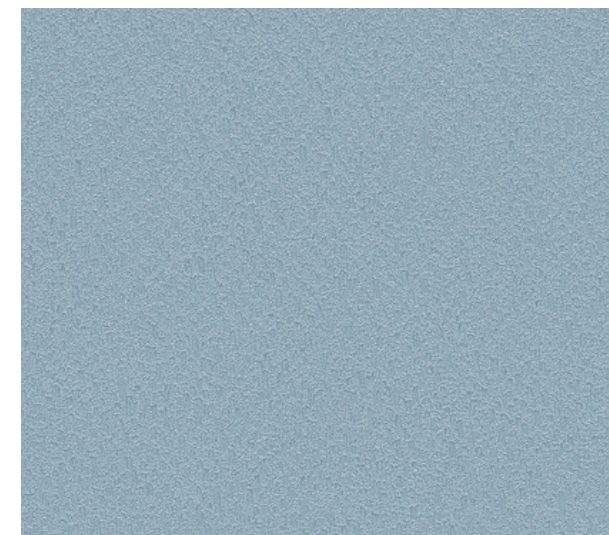

comet grey F6470112

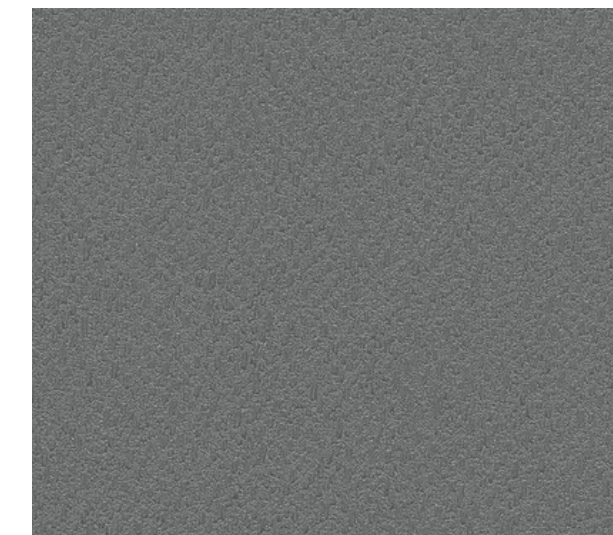

space grey F6470120



asteroid brown F6470121



Public Area



Hospitality



Residential



Fitness

Materialzusammensetzung:

ca. 84% PVC-Compound
ca. 16% Recycling PES-Gestrick
Gewicht: 740 +/- 50 g/m²
Dicke: 1,1 +/- 0,2 mm
Rollenbreite: 140 cm
Rollenlänge: 30m

Material composition:

approx. 84% PVC-compound
approx. 16% recycling PES-knitted fabric
Weight: 740 +/- 50 g/m²
Thickness: 1.1 +/- 0.2 mm
Roll width: 140cm
Roll length: 30m

Composición del material:

aprox. 84% compuesto de PVC
aprox. 16% reciclaje soporte textil de punto de PES
Peso: 740 +/- 50 g/m²
Espesor: 1,1 +/- 0,2 mm
Ancho de rollo: 140cm
Largo de rollo: 30m



langlebig
long-lasting
larga vida útil



reißfest
tear resistant
resistente al desgarro



abriebfest
abrasion resistant
resistencia a la abrasión
DIN EN ISO 5470-2:
≥ 50 000 Martindale
invers/inverse/inverso



schwer entflammbar
flame protection
resistencia al fuego
DIN EN 1021-1+2,
BS 5852 IS-O+1, MVSS302,
compliant with CAL AB
2998, IMO FTPC P8



pflegeleicht
easy to clean
fácil mantenimiento



lichtecht
lightfast
resistencia a la luz
DIN EN ISO 105-BS02,
Stufe 5, level 5, nivel 5



weich und dehnfähig
soft and stretchable
Suave y elástico



phthalatfrei
phthalate-free
no contiene ftalatos



vegan
vegan
vegano



Träger aus recycelter PES Faser
Recycled PES fibre backing
Soporte de fibra PES reciclada

Anwendung / Verarbeitung

Geeignet für viele Arten von Bepolsterungen und Spannungen in der Polsterindustrie. Besonders geeignet für den Einsatz im trendorientierten Wohn- und Objektbereich. Problemlose Verarbeitung nach den üblichen Verfahren (Nähen, Heften, Kleben, Nageln). Keine eingefärbten Kleber oder Lösemittelkleber verwenden!

Sonstige Hinweise

Zum Erhalt der Materialeigenschaften Ihres skai® Produktes ist eine regelmäßige Reinigung der Materialoberfläche erforderlich. Benutzen Sie hierzu den skai® Reiniger oder eine warme, milde Seifenlauge und ein Mikrofasertuch. Bitte verwenden Sie keine chemischen Bleichen oder scheuernde Reinigungsmittel. Bitte beachten Sie, dass Anfärbungen des Materials durch Jeans oder andere Textilien von jeglicher Gewährleistung ausgenommen sind.

Besondere Hinweise

Unsere anwendungstechnischen Empfehlungen in Wort und Schrift, die wir aufgrund unserer Erfahrung entsprechend dem aktuellen Stand der Technik weitergeben, sind unverbindlich. Sie entbinden den Käufer nicht davon, die Eignung unsere Produkte für den vorgesehenen Verwendungszweck in eigener Verantwortung selbst zu prüfen. Dies gilt insbesondere für alle Komponenten, die zusammen mit unserem Produkt verarbeitet werden und deren Verträglichkeit im Verbund. Im Übrigen gelten unsere allgemeinen Geschäftsbedingungen. Hiermit verlieren alle früheren, anderslautenden Regelungen ihre Gültigkeit.

Application / Processing

Suitable for many kinds of upholsteries and coverings in the upholstery industry. Especially suitable for the use in the modern residential and contract area. Problem-free processing in the usual procedures (sewing, tacking, sticking, nailing). Do not use colored adhesives or solvent adhesives!

Other instructions

To maintain the material properties of your skai® product, it is necessary to regularly clean the material surface. For cleaning, please use skai® cleaning agent or a warm, mild soapy water and a microfiber cloth. Please do not use chemical bleach or abrasive cleaning agents. Please note that staining of the material through jeans or other textiles is excluded from any warranty.

Special notes

Our spoken and written application engineering recommendations, which we pass on based on our experience and in accordance with the current state of the art, are non-binding. They do not absolve buyers of their own responsibility to check the suitability of our products for the intended purpose. This applies in particular to all components that are processed together with our product and their compatibility in combination with each other. Otherwise, our general terms and conditions are in effect. All earlier provisions to the contrary hereby become invalid.

Aplicaciones / Manipulación

Adecuado para numerosos tipos de tapizados y revestimientos en el sector de la tapicería. Especialmente adecuado para su uso en el ámbito residencial exclusivo y de tendencia. Aplicación sencilla por medio de procedimientos habituales (cosido, hilvanado, pegado, clavado). ¡No utilizar adhesivos tintados ni a base de disolventes!

Otros consejos

Para conservar las propiedades del material de su producto de skai® es necesario limpiar regularmente la superficie del material. Para ello, utilice skai® limpiador o agua jabonosa caliente y suave y un paño de microfibra. No utilice blanqueadores químicos ni productos de limpieza abrasivos. Tenga en cuenta que las manchas por decoloración en el material causadas por pantalones vaqueros u otros tejidos quedan excluidas de cualquier garantía.

Advertencias especiales

Las recomendaciones de aplicaciones técnicas que ofrecemos, ya sea de palabra o por escrito, en base a nuestra experiencia y conforme a los avances tecnológicos actuales, no son vinculantes. En ningún caso eximirán al comprador de comprobar por sí mismo y bajo su propia responsabilidad la idoneidad de nuestros productos para la finalidad de uso prevista. Esto se aplica especialmente para todos aquellos componentes que se utilicen junto con nuestro producto y su compatibilidad al combinarlos. En todo lo demás, se aplicarán nuestras condiciones generales, lo que supone la nulidad de cualquier otro acuerdo previo.



* nach den gesetzlichen Bestimmungen prescribed by law de conformidad con las disposiciones legales





skai® Paratexa NF
Textile Design

skai® Paratexa NF ist ein hochwertiger Polsterbezugsstoff mit einer sehr authentischen Textilloptik. Das Material überzeugt durch die Erfüllung der anspruchsvollen B1-Flammenschutznorm. Die trendige Farbauswahl, eine angenehme Haptik und eine extrem detaillierte Textilprägung machen skai® Paratexa NF zum echten Premiumprodukt.

skai® Paratexa NF is a high-quality upholstery material with a very realistic textile look. The material is notable due to its compliance with the rigorous B1-flame resistance standard. The trendy colours, pleasant feel, and extremely detailed embossing make skai® Paratexa NF a genuine premium product.

skai® Paratexa NF es un material de tapizado de alta calidad con una estética textil muy auténtica. Este material convence por el cumplimiento de la exigente norma de resistencia a la ignición B1. Su selección de colores de plena actualidad, su tacto agradable y su estampación textil tremendamente detallada hacen de skai® Paratexa NF un auténtico producto de primera clase.

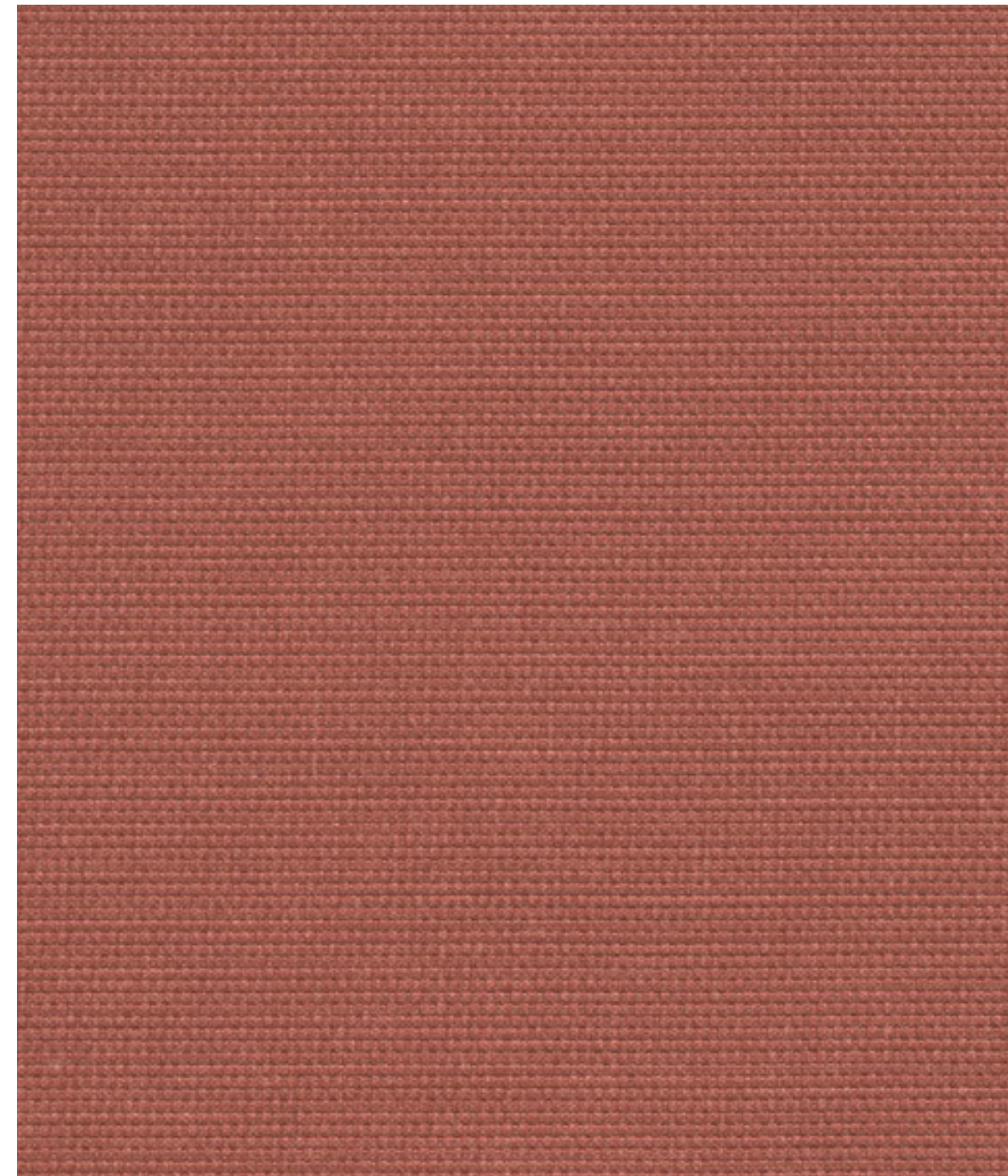

skai® Paratexa NF marsala F6411241

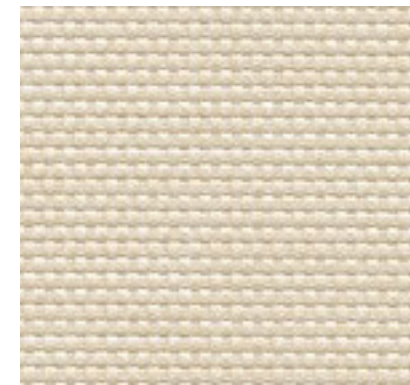
skai® Paratexa NF

ivory F6411239



cashmere F6411240



stone blue F6411243



arctic blue F6411210

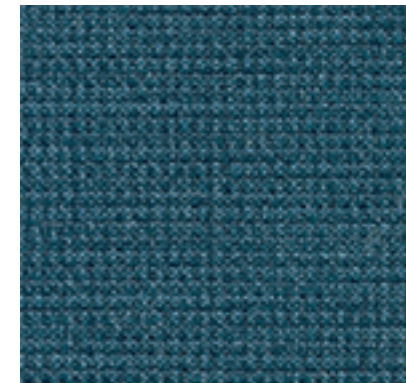

sapphire F6411211



deep sea F6411244

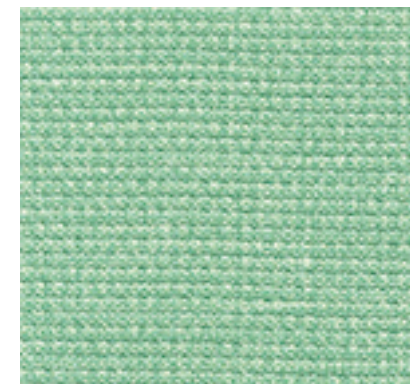

seafoam green F6411206



tourmaline F6411207



vineyard F6411242



birch F6411202



fango F6411208

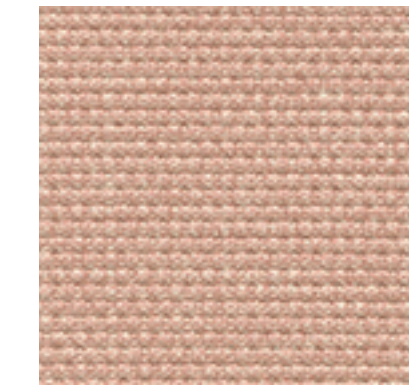

choco F6411205

skai® Paratexa NF

powder rose F6411203

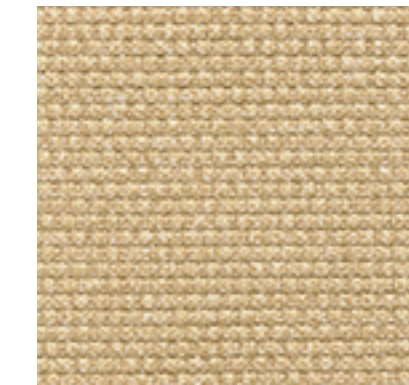

pearl F6411201



gobi F6411245



silvergrey F6411209

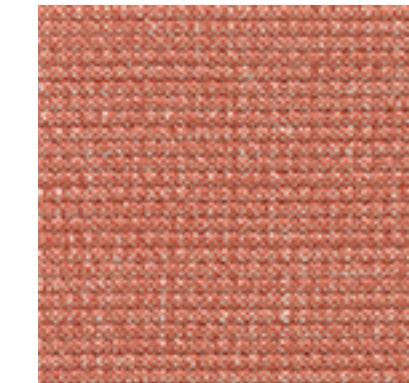

coral F6411204

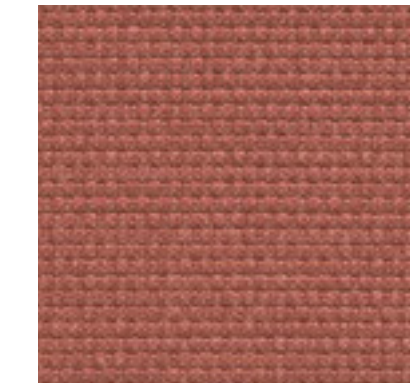

marsala F6411241

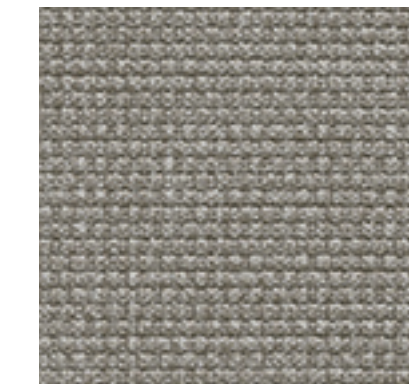

pewter F6411212

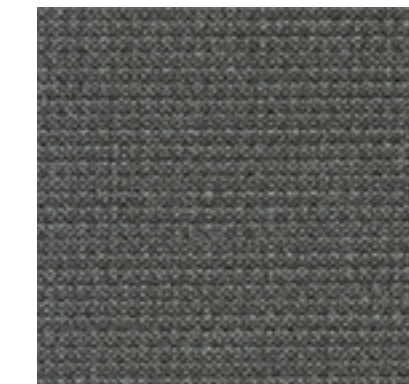

anthracite F6411213

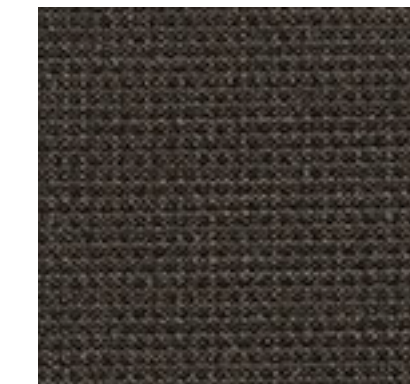

black F6411214



Public Area



Hospitality



Residential



Healthcare

Materialzusammensetzung:

85 % PVC-Compound
 15 % BW-Gestrick
Gewicht: 780 +/- 50 g/m²
Dicke: 1,3 +/- 0,2 mm
Rollenbreite: 137 cm
Rollenlänge: 30 m

Material composition:

85 % PVC-compound
 15 % CO-knitted fabric
Weight: 780 +/- 50 g/m²,
 34.5 +/- 2.2 oz/lyd
Thickness: 1.3 +/- 0.2 mm
Roll width: 137 cm / 54 in.
Roll length: 30 m / 32.8 yd

Composición del material:

85 % compuesto de PVC
 15 % textil de punto de algodón
Peso: 780 +/- 50 g/m²
Espesor: 1,3 +/- 0,2 mm
Ancho de rollo: 137 cm
Largo de rollo: 30 m



langlebig
 long-lasting
 larga vida útil



reißfest
 tear resistant
 resistente al desgarro



abriebfest
 abrasion resistant
 resistencia a la abrasión
DIN EN ISO 5470-2:
≥ 100 000 Martindale
invers/inverse/inverso
ASTM D4157 / CFFA-1A:
≥ 100 000
Abrieb Wyzenbeek
double rubs Wyzenbeek
doble frota Wyzenbeek



schwer entflammbar
 flame protection
 resistencia al fuego
DIN 4102-1 (Part 1, B1),
DIN 4102-1 (B2),
DIN EN 13501-1 B, s3, d0,
NF M1, AM 18,
BS5852 IS-O+1+5,
EN1021+1+2, MVSS302,
UNI 9175/87 (1.IM), CA TB
117-2013, UFAC/NFPA260
Class1, ASTM E 84



pflegeleicht
 easy to clean
 fácil mantenimiento



lichtecht
 lightfast
 resistente a la luz
DIN EN ISO 105-B02,
Stufe 6 / level 6 / nivel 6



blut- und urinbeständig
 blood- and urine resistant
 resistente a la sangre
 y a la orina



desinfektionsmittelbeständig
 disinfectant resistant
 resistente a los
 desinfectantes



vegan
 vegan
 vegano



0161/2023
IMO FTPC 2010 Part 8

Anwendung / Verarbeitung

Geeignet für viele Arten von Bepolsterungen und Bespannungen in der Polsterindustrie. Besonders geeignet für den Einsatz im trendorientierten Wohn- und Objektbereich, in öffentlichen Gebäuden und Einrichtungen. Problemlose Verarbeitung nach den üblichen Verfahren (Nähen, Heften, Kleben, Nageln). Keine eingefärbten Kleber oder Lösemittelkleber verwenden!

Sonstige Hinweise

Zum Erhalt der Materialeigenschaften Ihres skai® Produktes ist eine regelmäßige Reinigung der Materialoberfläche erforderlich. Benutzen Sie hierzu eine warme, milde Seifenlauge und ein Mikrofasertuch oder eine weiche Handbürste. Bitte verwenden Sie keine chemischen Bleichen oder scheuernde Reinigungsmittel. Bitte beachten Sie, dass Anfärbungen des Materials durch Jeans oder andere Textilien von jeglicher Gewährleistung ausgenommen sind.

Besondere Hinweise

Unsere anwendungstechnischen Empfehlungen in Wort und Schrift, die wir aufgrund unserer Erfahrung entsprechend dem aktuellen Stand der Technik weitergeben, sind unverbindlich. Sie entbinden den Käufer nicht davon, die Eignung unsere Produkte für den vorgesehenen Verwendungszweck in eigener Verantwortung selbst zu prüfen. Dies gilt insbesondere für alle Komponenten, die zusammen mit unserem Produkt verarbeitet werden und deren Verträglichkeit im Verbund. Im Übrigen gelten unsere allgemeinen Geschäftsbedingungen. Hiermit verlieren alle früheren, anderslautenden Regelungen ihre Gültigkeit.

Application / Processing

Suitable for many kinds of upholsteries and coverings in the upholstery industry. Especially suitable for the use in the modern residential and contract area, in public buildings and institutions. Problem-free processing in the usual procedures (sewing, tacking, sticking, nailing). Do not use colored adhesives or solvent adhesives!

Other instructions

To maintain the material properties of your skai® product, it is necessary to regularly clean the material surface. Use a warm, mild soap solution and a microfiber cloth or a soft hand brush for this purpose. Please do not use chemical bleach or abrasive cleaning agents. Please note that staining of the material through jeans or other textiles is excluded from any warranty.

Special notes

Our spoken and written application engineering recommendations, which we pass on based on our experience and in accordance with the current state of the art, are non-binding. They do not absolve buyers of their own responsibility to check the suitability of our products for the intended purpose. This applies in particular to all components that are processed together with our product and their compatibility in combination with each other. Otherwise, our general terms and conditions are in effect. All earlier provisions to the contrary hereby become invalid.

Aplicaciones / Manipulación

Apto para múltiples tipos de tapizado y revestimientos para la industria del mueble tapizado. Especialmente diseñado para el empleo en espacios modernos tanto públicos como privados, en edificios públicos e instituciones. Aplicación sencilla por medio de procedimientos habituales (cosido, hilvanado, pegado, clavado). ¡No utilizar adhesivos tintados ni a base de disolventes!

Otros consejos

Para conservar las propiedades del material de su producto de skai® es necesario limpiar regularmente la superficie del material. Utilice para ello lejía jabonosa suave y tibia con un paño de microfibra o un cepillo de mano suave. No utilice blanqueadores químicos ni productos de limpieza abrasivos. Tenga en cuenta que las manchas por decoloración en el material causadas por pantalones vaqueros u otros tejidos quedan excluidas de cualquier garantía.

Advertencias especiales

Las recomendaciones de aplicaciones técnicas que ofrecemos, ya sea de palabra o por escrito, en base a nuestra experiencia y conforme a los avances tecnológicos actuales, no son vinculantes. En ningún caso eximirán al comprador de comprobar por sí mismo y bajo su propia responsabilidad la idoneidad de nuestros productos para la finalidad de uso prevista. Esto se aplica especialmente para todos aquellos componentes que se utilicen junto con nuestro producto y su compatibilidad al combinarlos. En todo lo demás, se aplicarán nuestras condiciones generales, lo que supone la nulidad de cualquier otro acuerdo previo.



* nach den gesetzlichen Bestimmungen prescribed by law de conformidad con las disposiciones legales



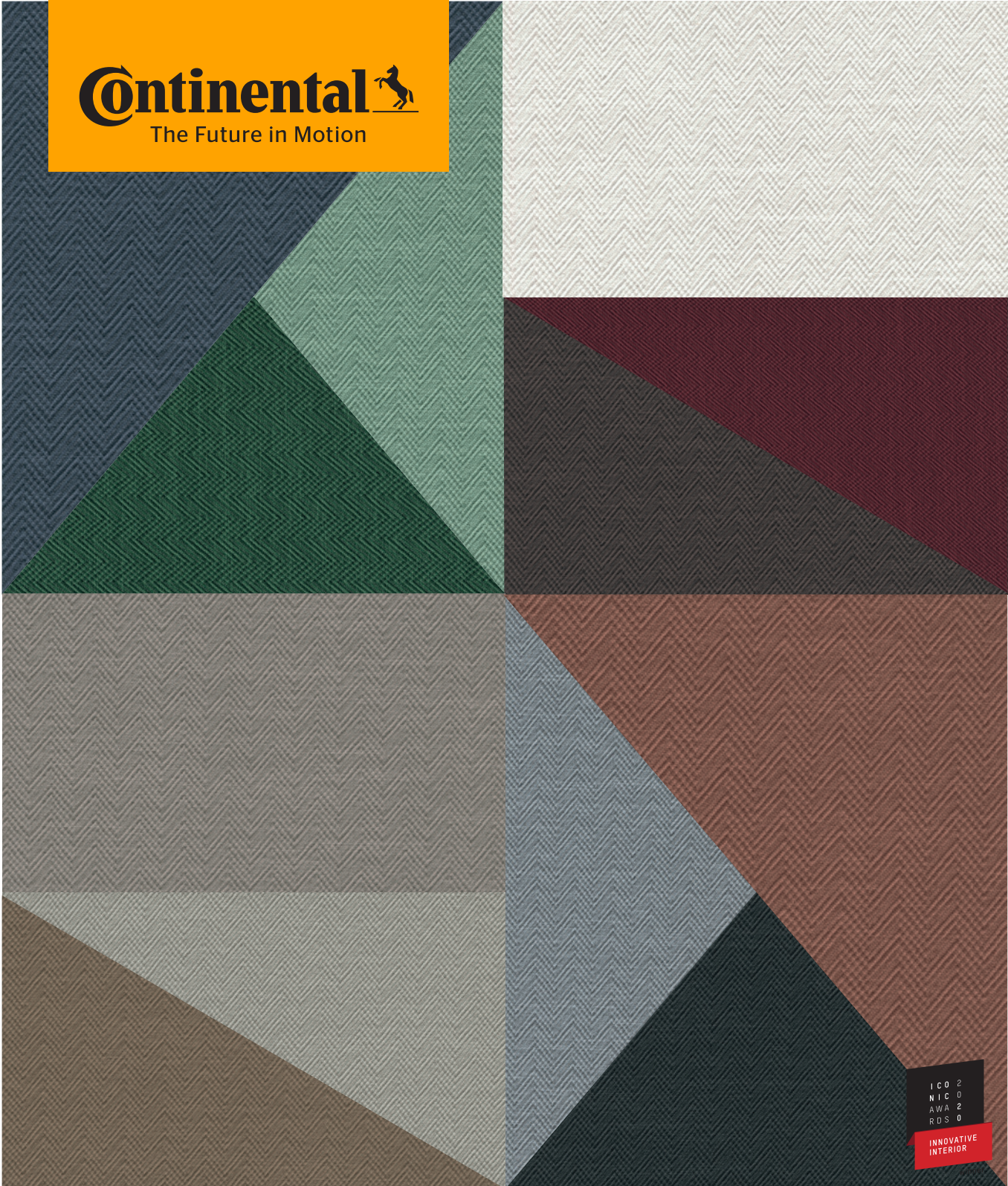

IC 2
NIC 0
AWA 2
RDS 0
INNOVATIVE
INTERIOR

skai® Torino FLS
Textile Design

Torino FLS

skai® Torino FLS

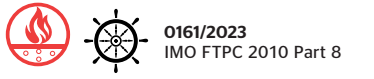
skai® Torino FLS

skai® Torino FLS ist ein hochwertiger Polsterbezugsstoff, bei dem klassisches Fischgrät-Design und eine feine Textilprägung eine moderne Textilanmutung erzielen. Ein Soft-Touch-Finish sorgt für eine angenehm weiche Haptik. Die pastellige Farbpalette spiegelt aktuelle Farbtrends.

skai® Torino FLS is a high-quality upholstery fabric in which a traditional herringbone design and a sophisticated textile embossing achieve a modern textile look. A soft-touch finish ensures a pleasantly smooth feel. The pastel color range reflects current color trends.

skai® Torino FLS es una tela de alta calidad para tapicería de acolchados con una moderna apariencia textil gracias al clásico diseño de espiga y al delicado gofrado. Con el acabado "soft touch" se consigue un agradable tacto suave. La gama de tonos pastel refleja las tendencias cromáticas actuales.

skai® Torino FLS white F6473014

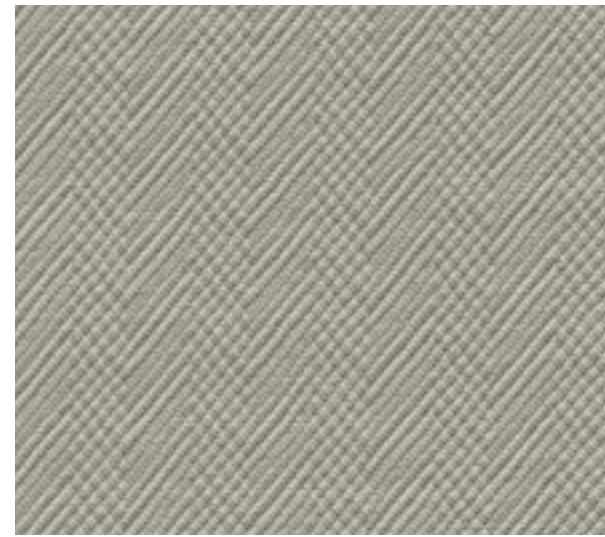
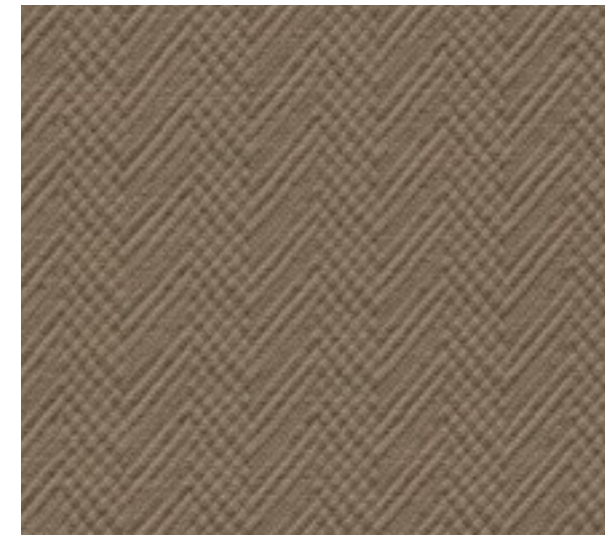
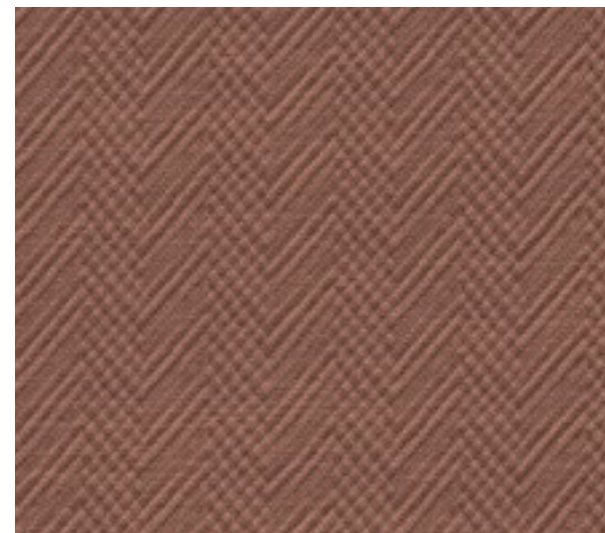
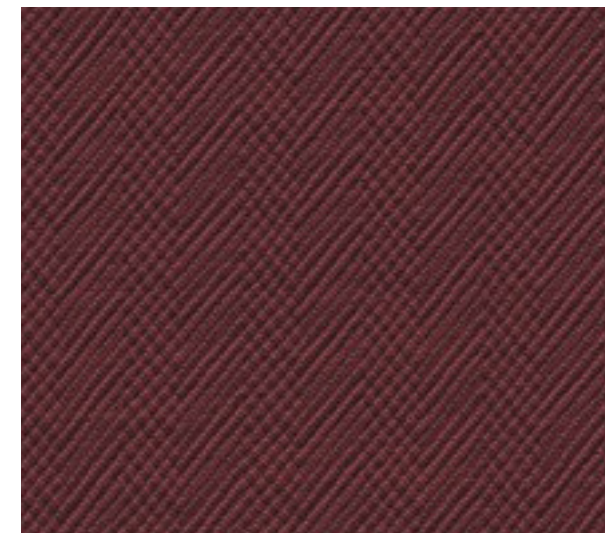
skai® Torino FLS cashmere F6473015

pebble F6473016

sand F6473017

teint F6473018

marsala F6473019

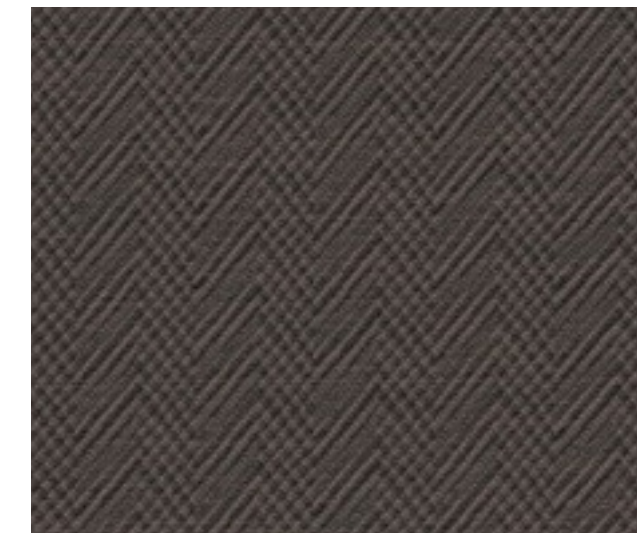
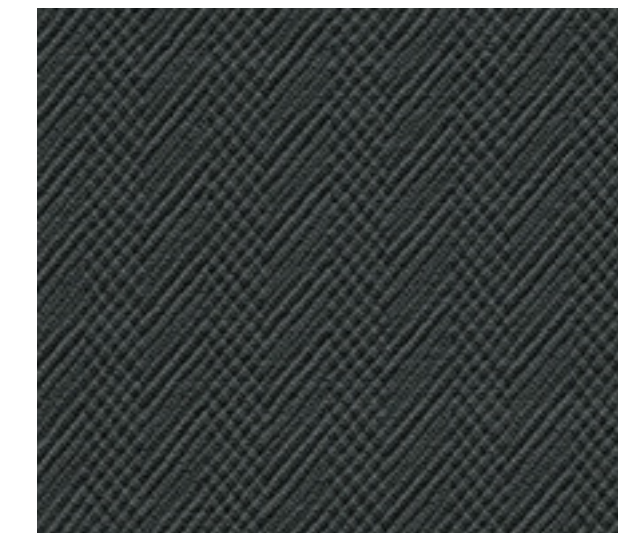
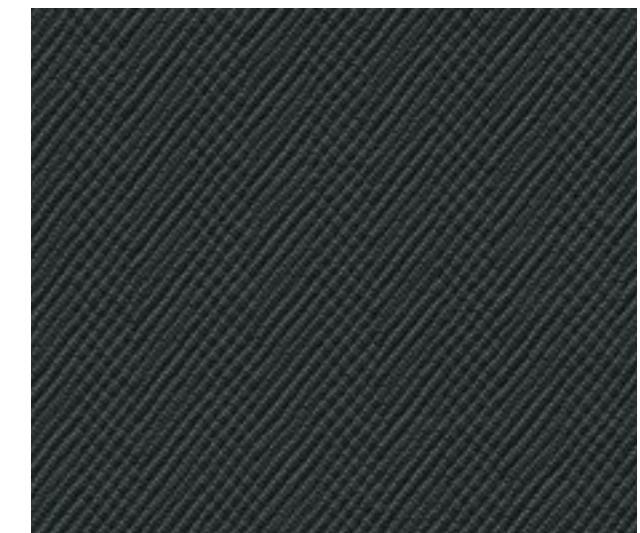
agave F6473021

vineyard F6473022

stone blue F6473023

deep sea F6473024

ashgrey F6473025

carob F6473020

anthracite F6473026

black F6473028



Public Area



Hospitality



Residential

Materialzusammensetzung:

ca. 1 % PU-Finish
ca. 84 % PVC-Compound
ca. 15 % BW/PES-Gestrick
Gewicht: 790 +/- 50 g/m²
Dicke: 1,4 +/- 0,2 mm
Rollenbreite: 140 cm
Rollenlänge: 30m

Material composition:

approx. 1 % PU-finish
approx. 84 % PVC-compound
approx. 15 % CO/PES-knitted fabric
Weight: 790 +/- 50 g/m²
35.7 +/- 2.3 oz/yd
Thickness: 1.4 +/- 0.2 mm
Roll width: 140cm / 55.1 in
Roll length: 30m / 32.8 yd

Composición del material:

aprox. 1 % de acabado de PU
aprox. 84 % compuesto de PVC
aprox. 15 % soporte textil de punto de PES
Peso: 790 +/- 50 g/m²
Espesor: 1,4 +/- 0,2 mm
Ancho de rollo: 140cm
Largo de rollo: 30m



langlebig
long-lasting
larga vida útil



reißfest
tear resistant
resistente al desgarro



schwer entflammbar
flame protection
resistencia al fuego
**DIN4102 (Part 1, B2),
NF M2, AM 18,
BS5852 IS-0+1+5,
DIN EN 1021-1+2, MVSS302,
CA TB 117-2013, UFAC/
NFPA260 Class 1**



abriebfest
abrasion resistant
resistencia a la abrasión
**DIN EN ISO 5470-2:
≥ 150 000 Martindale
invers/inverse/inverso
ASTM D4157 / CFFA-1A:
≥ 50 000
Abrieb Wyzenbeek
double rubs Wyzenbeek
doble frota Wyzenbeek**



pflegeleicht
easy to clean
fácil mantenimiento



lichtecht
lightfast
resistencia a la luz
**DIN EN ISO 105-BS02,
Stufe 6, level 6, nivel 6**



phthalatfrei
phthalate-free
no contiene ftalatos



lösungsmittelfrei
solvent free
exento de solvente



0161/2023
IMO FTPC 2010 Part 8



vegan
vegan
vegano

Anwendung / Verarbeitung

Geeignet für viele Arten von Bepolsterungen und Bespannungen in der Polsterindustrie, besonders für den Einsatz im trendorientierten und exklusiven Wohn- und Objektbereich. Problemlose Verarbeitung nach den üblichen Verfahren (Nähen, Heften, Kleben, Nageln). Keine eingefärbten Kleber oder Lösemittelkleber verwenden!

Sonstige Hinweise

Zum Erhalt der Materialeigenschaften Ihres skai® Produktes ist eine regelmäßige Reinigung der Materialoberfläche erforderlich. Benutzen Sie hierzu den skai® Reiniger oder eine warme, milde Seifenlauge und ein Mikrofasertuch. Bitte verwenden Sie keine chemischen Bleichen oder scheuernde Reinigungsmittel. Bitte beachten Sie, dass Anfärbungen des Materials durch Jeans oder andere Textilien von jeglicher Gewährleistung ausgenommen sind.

Besondere Hinweise

Unsere anwendungstechnischen Empfehlungen in Wort und Schrift, die wir aufgrund unserer Erfahrung entsprechend dem aktuellen Stand der Technik weitergeben, sind unverbindlich. Sie entbinden den Käufer nicht davon, die Eignung unsere Produkte für den vorgesehenen Verwendungszweck in eigener Verantwortung selbst zu prüfen. Dies gilt insbesondere für alle Komponenten, die zusammen mit unserem Produkt verarbeitet werden und deren Verträglichkeit im Verbund. Im Übrigen gelten unsere allgemeinen Geschäftsbedingungen. Hiermit verlieren alle früheren, anderslautenden Regelungen ihre Gültigkeit.

Application / Processing

Suitable for many kinds of upholsteries and coverings in the upholstery industry. Especially suitable in the modern and exclusive residential area and contract area. Problem-free processing in the usual procedures (sewing, tacking, sticking, nailing). Do not use colored adhesives or solvent adhesives!

Other instructions

To maintain the material properties of your skai® product, it is necessary to regularly clean the material surface. For cleaning, please use skai® cleaning agent or a warm, mild soapy water and a microfiber cloth. Please do not use chemical bleach or abrasive cleaning agents. Please note that staining of the material through jeans or other textiles is excluded from any warranty.

Special notes

Our spoken and written application engineering recommendations, which we pass on based on our experience and in accordance with the current state of the art, are non-binding. They do not absolve buyers of their own responsibility to check the suitability of our products for the intended purpose. This applies in particular to all components that are processed together with our product and their compatibility in combination with each other. Otherwise, our general terms and conditions are in effect. All earlier provisions to the contrary hereby become invalid.

Aplicaciones / Manipulación

Adecuado para numerosos tipos de tapizados y revestimientos en el sector de la tapicería, en especial en ámbitos como el sanitario, fitness, bienestar y hostelero. Aplicación sencilla por medio de procedimientos habituales (cosido, hilvanado, pegado, clavado). ¡No utilizar adhesivos tintados ni a base de disolventes!

Otros consejos

Para conservar las propiedades del material de su producto de skai® es necesario limpiar regularmente la superficie del material. Para ello, utilice skai® limpiador o agua jabonosa caliente y un paño de microfibra. No utilice blanqueadores químicos ni productos de limpieza abrasivos. Tenga en cuenta que las manchas por decoloración en el material causadas por pantalones vaqueros u otros tejidos quedan excluidas de cualquier garantía.

Advertencias especiales

Las recomendaciones de aplicaciones técnicas que ofrecemos, ya sea de palabra o por escrito, en base a nuestra experiencia y conforme a los avances tecnológicos actuales, no son vinculantes. En ningún caso eximirán al comprador de comprobar por sí mismo y bajo su propia responsabilidad la idoneidad de nuestros productos para la finalidad de uso prevista. Esto se aplica especialmente para todos aquellos componentes que se utilicen junto con nuestro producto y su compatibilidad al combinarlos. En todo lo demás, se aplicarán nuestras condiciones generales, lo que supone la nulidad de cualquier otro acuerdo previo.



* nach den gesetzlichen Bestimmungen prescribed by law de conformidad con las disposiciones legales



Continental 
The Future in Motion



skai® Pandoria Plus
Textile Design

skai® Pandoria Plus ist ein hochwertiger Polsterbezugstoff, dessen feine Mikroporenstruktur eine dezente Optik ergibt, die durch einen Ton-in-Ton-Effekt veredelt wird. Die angenehme Haptik des Materials sowie die hervorragende Materialeigenschaften und das breite, aktuelle Farbspektrum machen skai® Pandoria Plus universell einsetzbar.

skai® Pandoria Plus is a high-quality upholstery material, whose fine micropore structure gives a certain unobtrusiveness, which is refined by an attractive tone-in-tone effect. The very pleasant feel of the material and the excellent material characteristic and the broad, modern color spectrum make skai® Pandoria Plus universally usable.

skai® Pandoria Plus es un material de tapizado de alta calidad cuya estructura microporosa le aporta una estética discreta, realzada por un efecto de tono sobre tono. El agradable tacto del material, así como sus excepcionales propiedades y su amplia gama de colores, permite emplear skai® Pandoria Plus en todo tipo de aplicaciones.

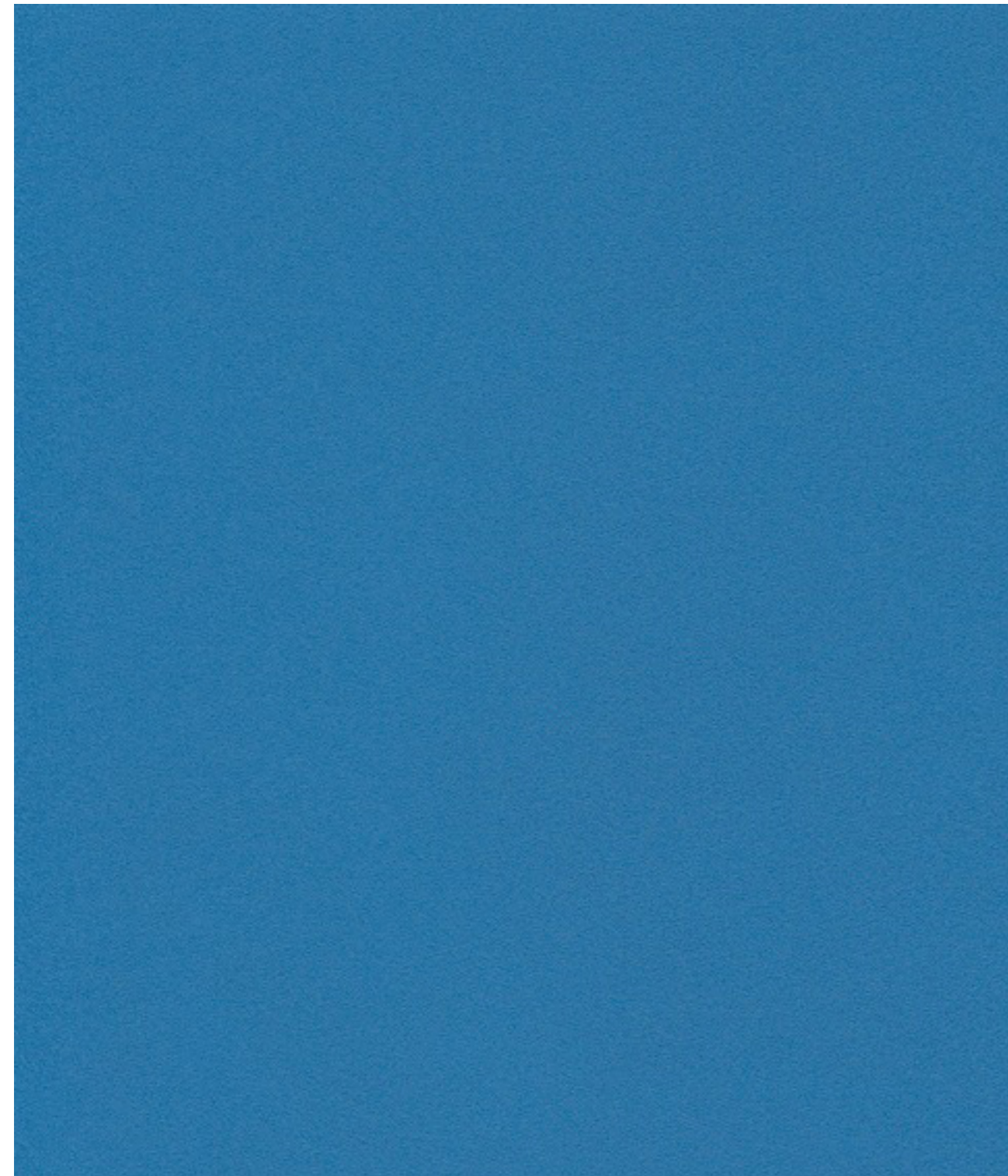
skai® Pandoria Plus sky F6413074

skai® Pandoria Plus

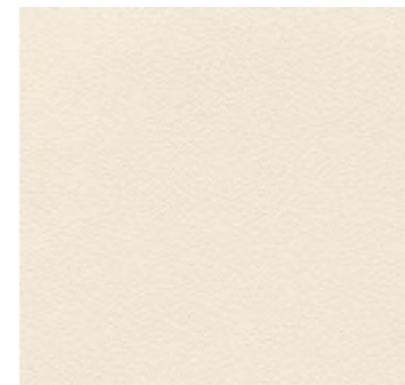

weiß F6413046



hellbeige F6413047

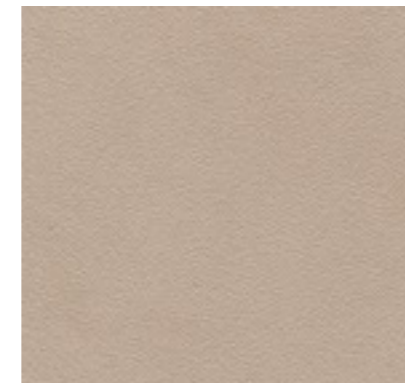

kiesel F6413048



birke F6413049

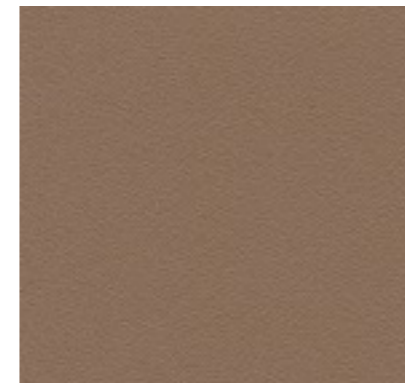

smoke F6413050

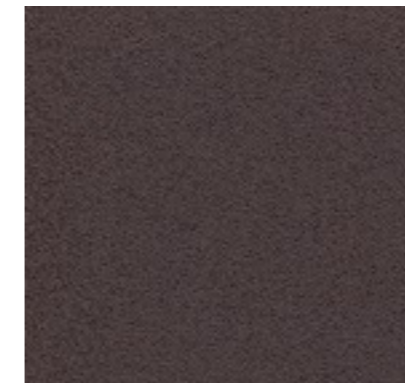

schoko F6413051

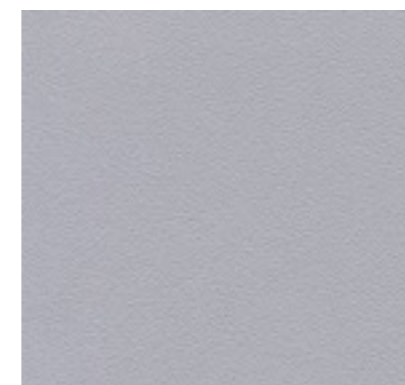

silbergrau F6413075



platin F6413053



anthrazit F6413076

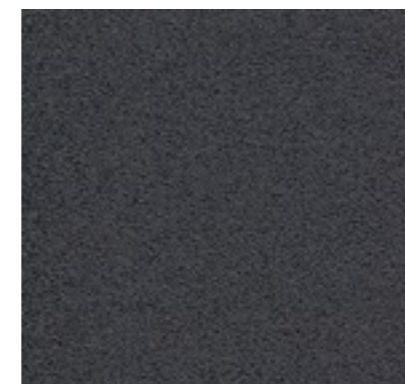

schwarz F6413052



gletscher F6413055

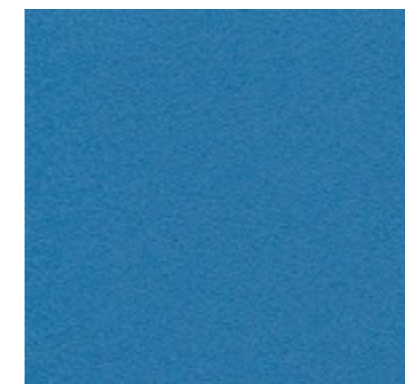

sky F6413074

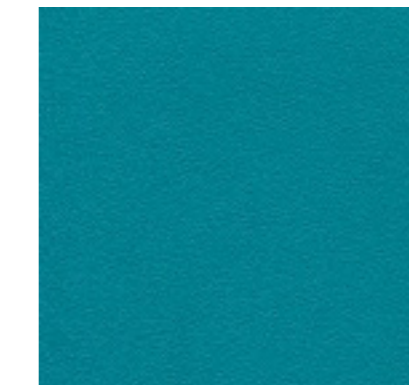
skai® Pandoria Plus

smaragd F6413073

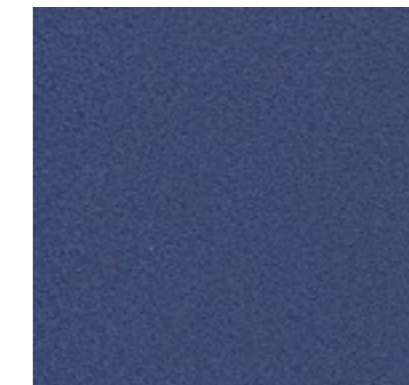

royal F6413056



mais F6413057



feuer F6413058

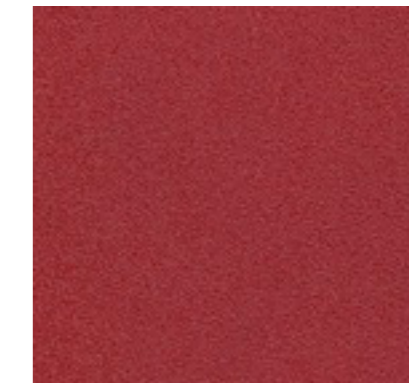

kirsche F6413079



fuchsia F6413078



limone F6413054

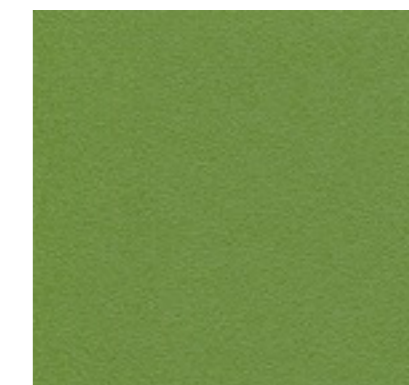

kaktus F6413077



Public Area



Hospitality



Residential



Healthcare



Fitness

Materialzusammensetzung:

ca. 3% PVC-PU-Finish
 ca. 12% BW/PES-Gestrick
 ca. 85% PVC-Compound
Gewicht: 800 +/- 50 g/m²
Dicke: 1,35 +/- 0,2 mm
Rollenbreite: 140 cm
Rollenlänge: 25 m

Material composition:

approx. 3% PVC-PU finish
 approx. 12% CO/PES knitted fabric
 approx. 85% PVC compound
weight: 800 +/- 50 g/m²
thickness: 1.35 +/- 0.2 mm
roll width: 140 cm
roll length: 25 m

Composición del material:

aprox. 3% PVC-PU finish
 aprox. 12% soporte textil de punto de algodón/PES
 aprox. 85% compuesto de PVC
Peso: 800 +/- 50 g/m²
Espesor: 1,35 +/- 0,2 mm
Ancho de rollo: 140 cm
largo de rollo: 25 m



langlebig
 long-lasting
 larga vida útil



reißfest
 tear resistant
 resistente al desgarro



pflegeleicht
 easy to clean
 fácil mantenimiento



abriebfest
 abrasion resistant
 resistencia a la abrasión
DIN EN ISO 5470-2:
≥ 300 000 Martindale
 invers/inverse/inverso



öl- und fettbeständig
 resistant to oil and fat
 resistente a aceites y grasas



lichtecht
 lightfast
 resistente a la luz
DIN EN ISO 105-B02,
Stufe 6 / level 6 / nivel 6



desinfektionsmittelbeständig
 disinfectant resistant
 resistente a los
 desinfectantes



schwer entflammbar
 flame protection
 resistencia al fuego
NF M2, BS 5852 IS-O+1,
DIN 4102 (Part 1, B2),
DIN EN 1021 1+2,
MVSS302, FAR 25.853



erfüllt Medizinproduktegesetz
 fulfills medical standard
 cumple la normativa para
 productos sanitarios
DIN EN ISO 10993-5+10



schweiß-, urin- und blutbeständig
 resistant to sudor, blood and urine
 resistente al sudor, la orina y la sangre



0161/2023
IMO FTPC 2010 Part 8



vegan
 vegan
 vegano



antibakteriell nach ISO 22196
 antibacterial according to ISO 22196
 Antibacteriano según ISO 22196
 antimikrobiell
 antimicrobial
 antimicrobiana

Anwendung / Verarbeitung

Geeignet für viele Arten von Polsterungen und Bespannungen, insbesondere im Medizin-, Fitness-, Wellness- und Physiotherapiebereich sowie im Objektbereich und in der Gastronomie. Problemlose Verarbeitung nach den üblichen Verfahren (Nähen, Heften, Kleben, Nageln). Keine eingefärbten Kleber oder Lösemittelkleber verwenden!

Sonstige Hinweise

Zum Erhalt der Materialeigenschaften Ihres skai® Produktes ist eine regelmäßige Reinigung der Materialoberfläche erforderlich. Benutzen Sie hierzu den skai® Reiniger oder eine warme, milde Seifenlauge und ein Mikrofasertuch. Bitte verwenden Sie keine chemischen Bleichen oder scheuernde Reinigungsmittel. Bitte beachten Sie, dass Anfärbungen des Materials durch Jeans oder andere Textilien von jeglicher Gewährleistung ausgenommen sind.

Besondere Hinweise

Unsere anwendungstechnischen Empfehlungen in Wort und Schrift, die wir aufgrund unserer Erfahrung entsprechend dem aktuellen Stand der Technik weitergeben, sind unverbindlich. Sie entbinden den Käufer nicht davon, die Eignung unsere Produkte für den vorgesehenen Verwendungszweck in eigener Verantwortung selbst zu prüfen. Dies gilt insbesondere für alle Komponenten, die zusammen mit unserem Produkt verarbeitet werden und deren Verträglichkeit im Verbund. Im Übrigen gelten unsere allgemeinen Geschäftsbedingungen. Hiermit verlieren alle früheren, anderslautenden Regelungen ihre Gültigkeit. ihre Gültigkeit.

Application / Processing

Suitable for many types of upholstery and coverings, especially in the area of medicine, fitness, wellness, and physical therapy, as well as in commercial and gastronomy sectors. Problem-free processing in the usual procedures (sewing, tacking, sticking, nailing). Do not use colored adhesives or solvent adhesives!

Other instructions

To maintain the material properties of your skai® product, it is necessary to regularly clean the material surface. For cleaning, please use skai® cleaning agent or a warm, mild soapy water and a microfiber cloth. Please do not use chemical bleach or abrasive cleaning agents. Please note that staining of the material through jeans or other textiles is excluded from any warranty.

Special notes

Our spoken and written application engineering recommendations, which we pass on based on our experience and in accordance with the current state of the art, are non-binding. They do not absolve buyers of their own responsibility to check the suitability of our products for the intended purpose. This applies in particular to all components that are processed together with our product and their compatibility in combination with each other. Otherwise, our general terms and conditions are in effect. All earlier provisions to the contrary hereby become invalid.

Aplicaciones / Manipulación

Adecuado para numerosos tipos de tapizados y revestimientos en el sector de la tapicería, en especial en ámbitos como el sanitario, fitness, bienestar y hostelero. Aplicación sencilla por medio de procedimientos habituales (cosido, hilvanado, pegado, clavado). ¡No utilizar adhesivos tintados ni a base de disolventes!

Otros consejos

Para conservar las propiedades del material de su producto de skai® es necesario limpiar regularmente la superficie del material. Para ello, utilice skai® limpiador o agua jabonosa caliente y suave y un paño de microfibra. No utilice blanqueadores químicos ni productos de limpieza abrasivos. Tenga en cuenta que las manchas por decoloración en el material causadas por pantalones vaqueros u otros tejidos quedan excluidas de cualquier garantía.

Advertencias especiales

Las recomendaciones de aplicaciones técnicas que ofrecemos, ya sea de palabra o por escrito, en base a nuestra experiencia y conforme a los avances tecnológicos actuales, no son vinculantes. En ningún caso eximirán al comprador de comprobar por sí mismo y bajo su propia responsabilidad la idoneidad de nuestros productos para la finalidad de uso prevista. Esto se aplica especialmente para todos aquellos componentes que se utilicen junto con nuestro producto y su compatibilidad al combinarlos. En todo lo demás, se aplicarán nuestras condiciones generales, lo que supone la nulidad de cualquier otro acuerdo previo.



* nach den gesetzlichen Bestimmungen prescribed by law de conformidad con las disposiciones legales







Foto: © Novotel Angers Centre Gare

skai® Makari
Textile Design

Der hochwertige Polsterbezugstoff zeichnet sich durch eine detailreiche Textilloptik aus. Ein spezieller Textildruck und die geradlinige Prägung lassen das Material noch authentischer wirken. In trendigen Farben bietet das Material eine große Vielfalt für den Einsatz im Hospitality-Bereich.

The high-quality upholstery material is characterized by a detailed textile look. Special textile printing and straight embossing make the material seem even more realistic. With trendy colors, the material offers great versatility for use in the hospitality industry.

Este material de tapizado de alta calidad se caracteriza por su fiel estética textil. Su estampado textil especial y su relieve lineal aportan aún más realismo al material. Con sus colores de plena actualidad, este material ofrece una gran versatilidad para su uso en el sector hostelero.

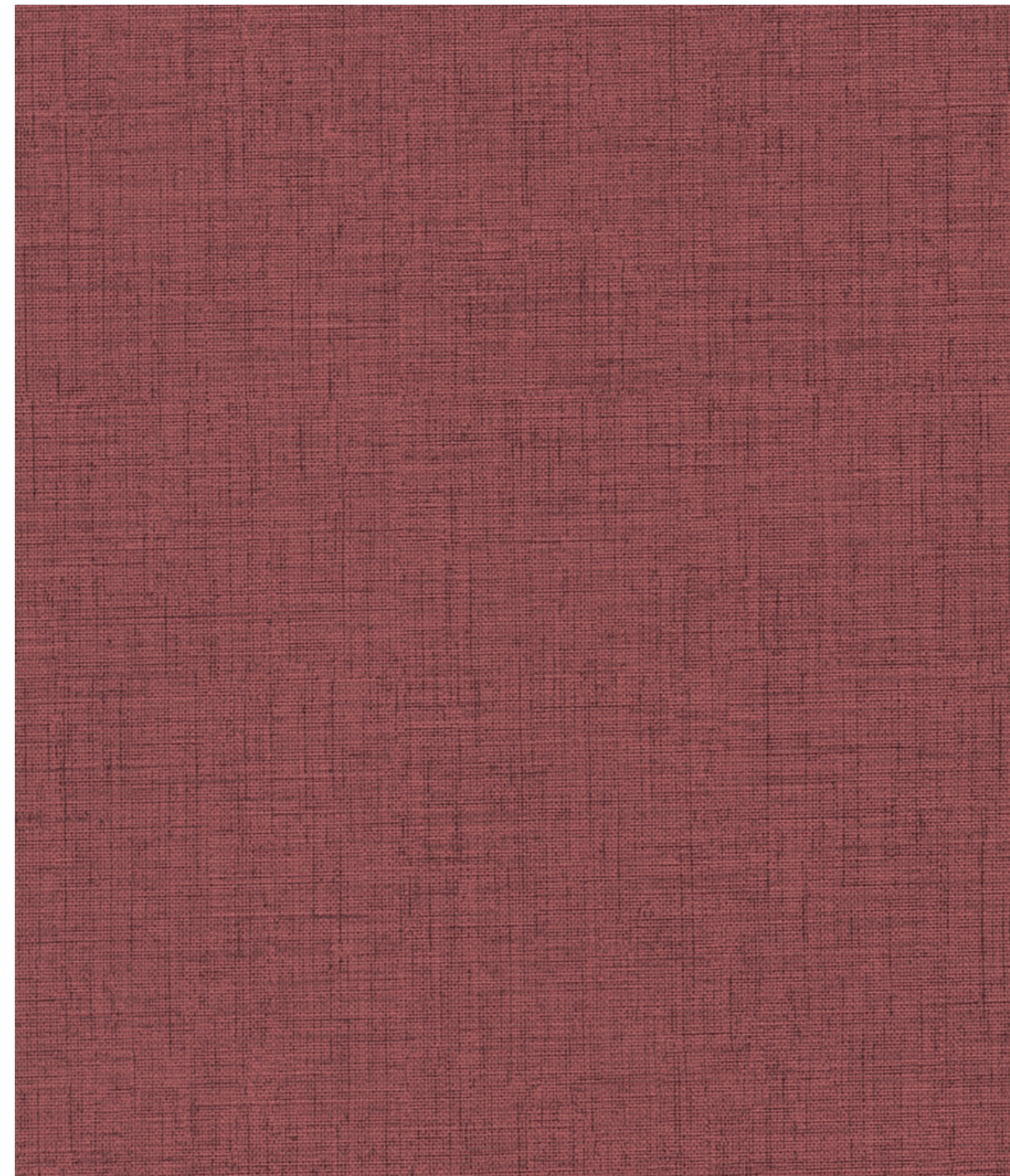

skai® Makari marsala F6425056



white F6425045	sand F6425044	creme F6425053	stone F6425049
light brown F6425043	beige F6425052	light orange F6425038	orange F6425036
pebble F6425054	cinder F6425055	dark stone F6425051	dark brown F6425042
marsala F6425056	fuchsia F6425035	bordeaux F6425034	red F6425037
terracota F6425057	nude F6425058	oil F6425050	cobalt F6425039



ashgrey F6425059	grey F6425046	dark grey F6425048	black F6425047
frost F6425060	turquoise F6425030	blue-grey F6425041	blue F6425040
pistache F6425031	light green F6425032	green F6425033	vineyard F6425061

skai® Surfaces Protective Finish

Protective finish
Advanced technology that protects the article against the stains, making it easier to clean and maintaining the initial appearance for longer (slower aging).

Antifungal and antibacteria treatment

PVC Layer

Textile support

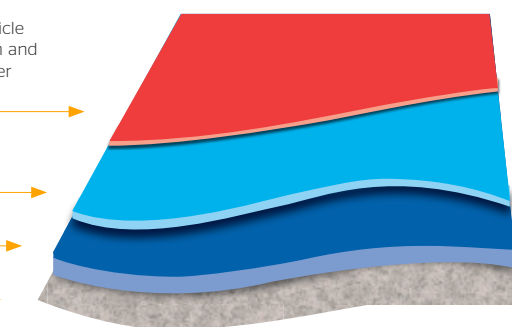



Public Area



Hospitality



Residential



Healthcare

Materialzusammensetzung:

ca. 89% PVC-Compound
ca. 11% Baumwolle
Gewicht: 800 +/- 60 g/m²
Dicke: 1,3 +/- 0,2 mm
Rollenbreite: 140 cm
Rollenlänge: 30m

Material composition:

approx. 89% PVC-compound
approx. 11% Cotton
Weight: 800 +/- 60 g/m²
Thickness: 1.3 +/- 0.2 mm
Roll width: 140 cm
Roll length: 30m

Composición del material:

aprox. 89% compuesto de PVC
aprox. 11% Algodón
Peso: 800 +/- 60 g/m²
Espesor: 1,3 +/- 0,2 mm
Ancho de rollo: 140 cm
Largo de rollo: 30m



lichtecht
lightfast
resistente a la luz
DIN EN ISO 105-B02,
Stufe 6 / level 6 / nivel 6



abriebfest
abrasion resistant
resistencia a la abrasión
DIN EN ISO 5470-2:
≥ 150 000 Martindale
invers/inverse/inverso



lösungsmittelfrei
solvent free
exento de solvente



schwer entflammbar
flame protection
resistencia al fuego
EN 1021 (1-2), M2, B2,
BS 5852 (CRIB 5),
IMO FTPC 2010 Part 8



salzwasserbeständig
salt water resistant
resistente al agua salada
DIN EN ISO 9227



antibakteriell/antimikrobiell
antibacterial/antimicrobial
antibacteriano/antimicrobiana



schweiß-, urin- und blutbeständig
resistant to sudor, blood and urine
resistente al sudor, la orina y la sangre



vegan
vegan
vegano

Anwendung / Verarbeitung

Geeignet für viele Arten von Bepolsterungen und Bespannungen in der Polsterindustrie. Besonders geeignet für den Einsatz im trendorientierten Wohn- und Objektbereich, in öffentlichen Gebäuden und Einrichtungen. Problemlose Verarbeitung nach den üblichen Verfahren (Nähen, Heften, Kleben, Nageln). Keine Lösemittelkleber verwenden!

Sonstige Hinweise

Zum Erhalt der Materialeigenschaften Ihres skai® Produktes ist eine regelmäßige Reinigung der Materialoberfläche erforderlich. Benutzen Sie hierzu den skai® Reiniger oder eine warme, milde Seifenlauge und ein Mikrofaser Tuch. Bitte verwenden Sie keine chemischen Bleichen oder scheuernde Reinigungsmittel. Bitte beachten Sie, dass Anfärbungen des Materials durch Jeans oder andere Textilien von jeglicher Gewährleistung ausgenommen sind.

Besondere Hinweise

Unsere anwendungstechnischen Empfehlungen in Wort und Schrift, die wir aufgrund unserer Erfahrung entsprechend dem aktuellen Kenntnisstand weitergeben, sind unverbindlich und begründen kein Rechtsverhältnis und keine Nebenverpflichtungen aus dem Kaufvertrag. Sie entbinden den Käufer nicht davon, unsere Produkte für den vorgesehenen Verwendungszweck in eigener Verantwortung selbst zu prüfen. Im Übrigen gelten unsere allgemeinen Geschäftsbedingungen. Hiermit verlieren alle früheren, anderslautenden Regelungen ihre Gültigkeit.

Application / Processing

Suitable for many kinds of upholsteries and coverings in the upholstery industry. Especially suitable for the use in the modern residential and contract area, in public buildings and institutions. Problem-free processing in the usual procedures (sewing, tacking, sticking, nailing). Do not use solvent-based adhesives!

Other instructions

To maintain the material properties of your skai® product, it is necessary to regularly clean the material surface. For cleaning, please use skai® cleaning agent or a warm, mild soapy water and a microfiber cloth. Please do not use chemical bleach or abrasive cleaning agents. Please note that staining of the material through jeans or other textiles is excluded from any warranty.

Special notes

Our written and spoken technical recommendations, which we provide based on our experience in accordance with the current state of knowledge, are nonbinding and do not constitute a legal relationship and are not additional obligations from the purchase agreement. They do not release the purchaser from checking our products for the intended use under his own responsibility. Otherwise, our general terms and conditions are in effect. All earlier provisions to the contrary hereby become invalid.

Aplicaciones / Manipulación

Apto para múltiples tipos de tapizado y revestimientos para la industria del mueble tapizado. Especialmente diseñado para el empleo en espacios modernos tanto públicos como privados, en edificios públicos e instituciones. Aplicación sencilla por medio de procedimientos habituales (cosido, hilvanado, pegado, clavado). No usar pegamento disolvente.

Otros consejos

Para conservar las propiedades del material de su producto de skai® es necesario limpiar regularmente la superficie del material. Para ello, utilice skai® limpiador o agua jabonosa caliente y suave y un paño de microfibra. No utilice blanqueadores químicos ni productos de limpieza abrasivos. Tenga en cuenta que las manchas por decoloración en el material causadas por pantalones vaqueros u otros tejidos quedan excluidas de cualquier garantía.

Advertencias especiales

Nuestras recomendaciones técnicas de aplicación, verbales o escritas, que facilitemos sobre la base de nuestra experiencia y de los conocimientos técnicos más actuales, no son vinculantes en ningún caso ni constituyen un compromiso contractual o responsabilidades añadidas al contrato de compraventa. No eximen al comprador de verificar personalmente nuestros productos para el uso previsto y bajo su responsabilidad. En todo lo demás, se aplicarán nuestras condiciones generales, lo que supone la nulidad de cualquier otro acuerdo previo.



* nach den gesetzlichen Bestimmungen prescribed by law de conformidad con las disposiciones legales



DIN EN ISO 14001
DIN EN ISO 45001
DIN EN ISO 9001
IATF 16949

Continental 
The Future in Motion

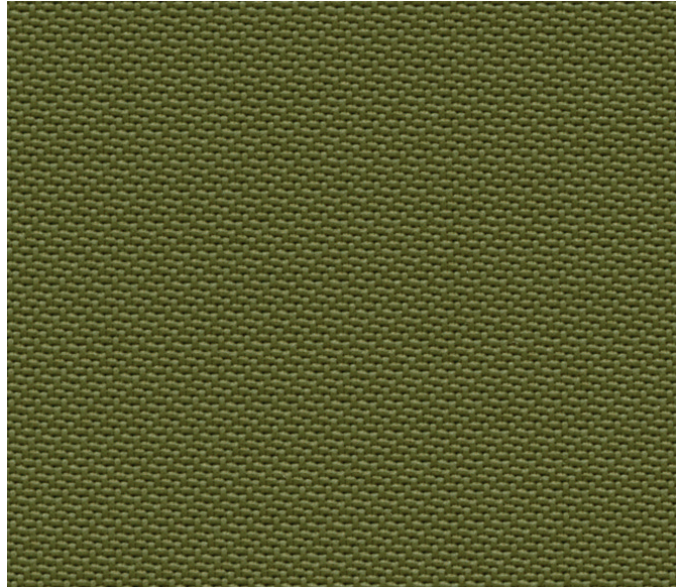
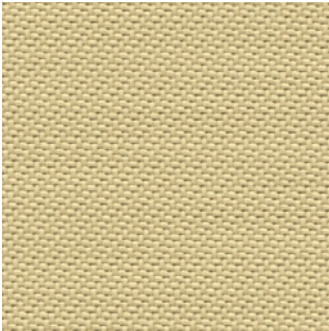
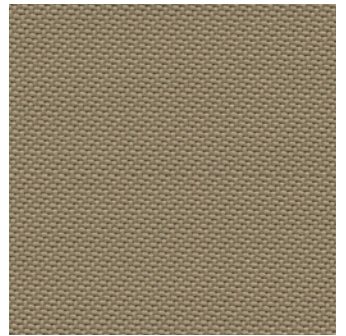

skai[®] Galeno
Textile Design

Der hochwertige Polsterbezugstoff skai® Galeno zeichnet sich durch eine äußerst feine, authentische Textilstruktur aus, die sowohl optisch als auch haptisch beeindruckt. Die umfangreiche Farbpalette macht skai® Galeno für den Einsatz im Hospitality-Bereich perfekt.

The high-quality upholstery fabric skai® Galeno is characterized by an extremely fine, authentic textile structure that impresses both visually and haptically. The extensive color range makes skai® Galeno perfect for use in the hospitality sector.

El tejido de tapicería de alta calidad skai® Galeno se caracteriza por una estructura textil extremadamente fina y auténtica que impresiona tanto visual como táctilmente. La amplia gama de colores hace que skai® Galeno sea perfecto para su uso en el sector de la hostelería.



skai® Galeno stone F6425326

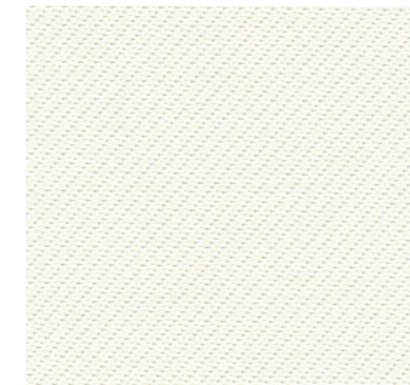

white F6425319

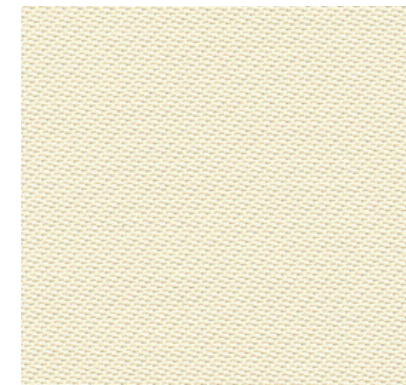

light beige F6425320

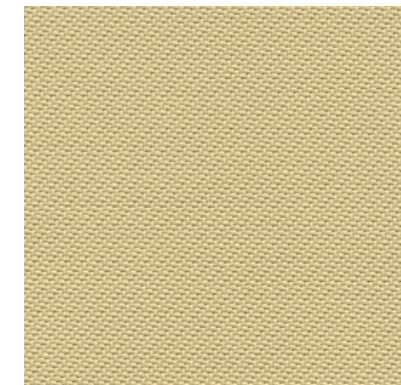

beige F6425321

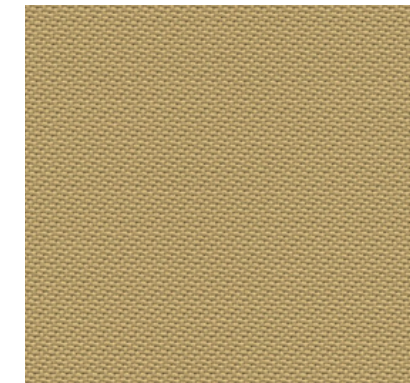

sand F6425322

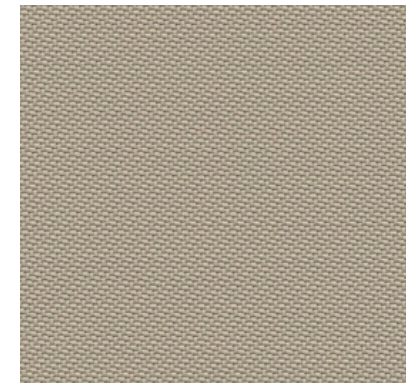

light stone F6425323

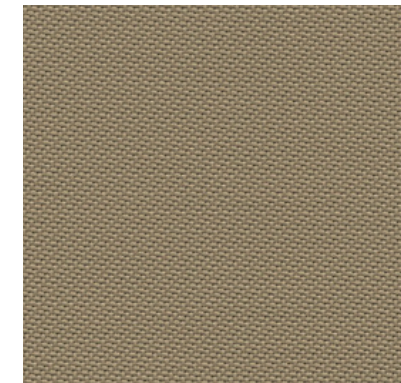

taupe F6425324

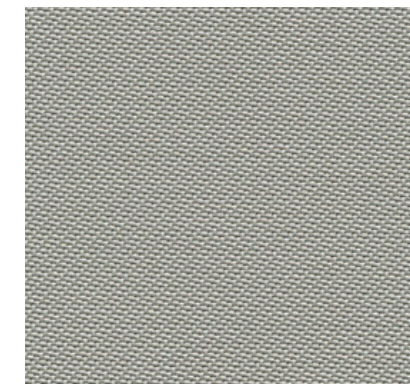

silver F6425330

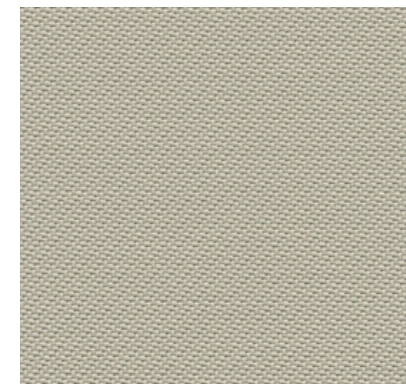

light grey F6425327

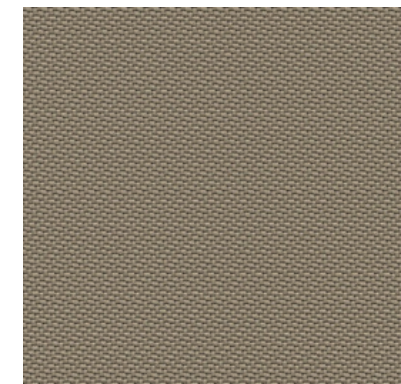

stone F6425326

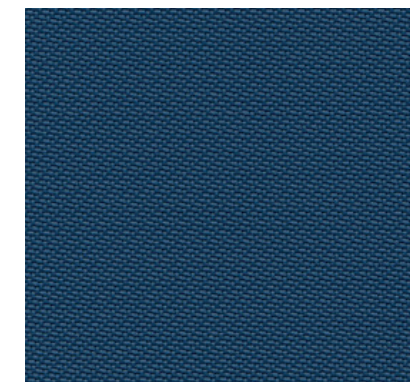

navy F6425312

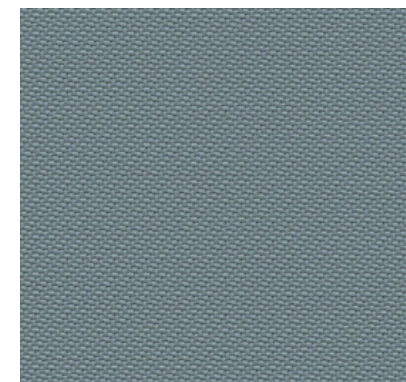

blue grey F6425313

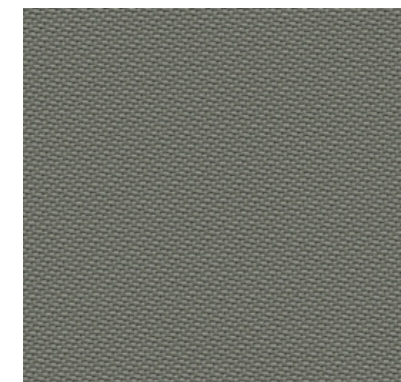

grey F6425329

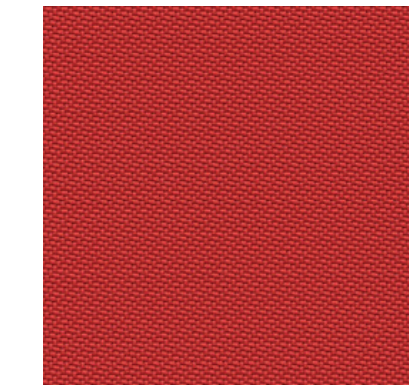

red F6425307

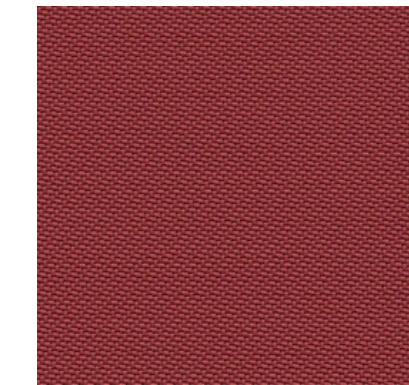

dark red F6425308

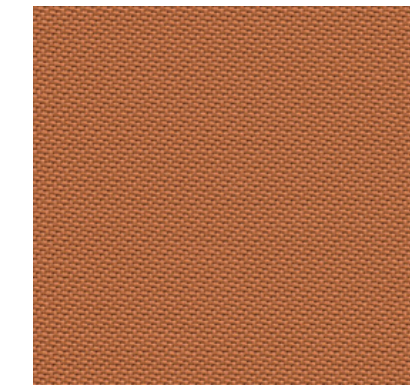

copper F6425314

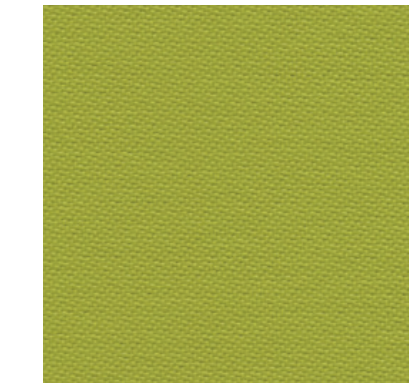

pistache F6425300

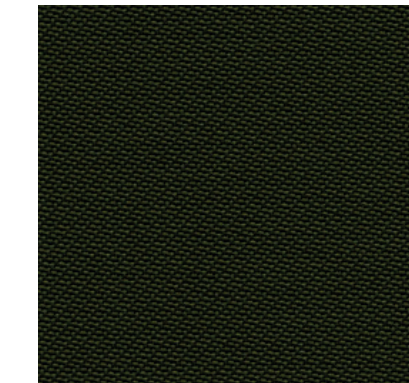

dark green F6425302

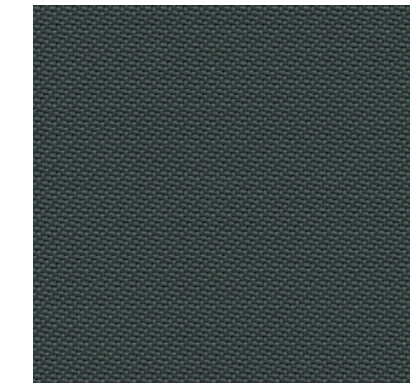

dark grey F6425328

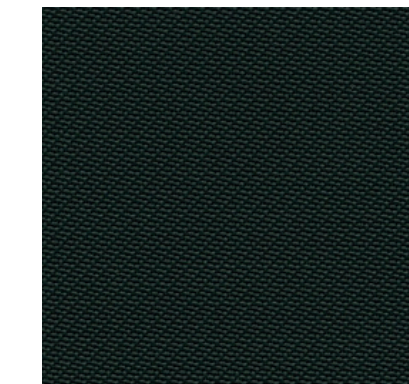

black F6425325

skai® Surfaces Protective Finish

Protective finish
Advanced technology that protects the article against the stains, making it easier to clean and maintaining the initial appearance for longer (slower aging).

Antifungal and antibacteria treatment

PVC Layer

Textile support

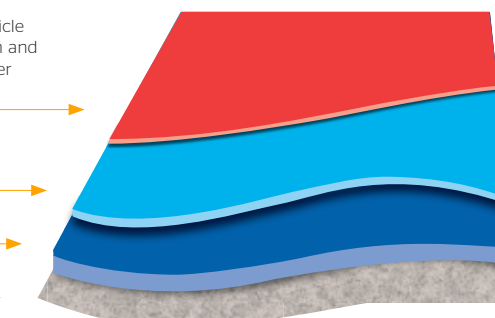



Public Area



Hospitality



Residential



Healthcare

Materialzusammensetzung:

ca. 89% PVC-Compound
ca. 7% Polyester
ca. 4% Baumwolle
Gewicht: 820 +/- 80 g/m²
Dicke: 1,1 +/- 0,2 mm
Rollenbreite: 140cm
Rollenlänge: 30m

Material composition:

approx. 89% PVC-compound
approx. 7% Polyester
approx. 4% Cotton
Weight: 820 +/- 80 g/m²
37.0 +/- 3.6 oz/yd
Thickness: 1.1 +/- 0.2 mm
Roll width: 140cm / 55.1 in.
Roll length: 30m / 32.8 yd

Composición del material:

aprox. 89% compuesto de PVC
aprox. 7% Poliéster
aprox. 4% Algodón
Peso: 820 +/- 80 g/m²
Espesor: 1,1 +/- 0,2 mm
Ancho de rollo: 140cm
Largo de rollo: 30m



lichtecht
lightfast
resistente a la luz
DIN EN ISO 105-B02,
Stufe 6 / level 6 / nivel 6



lösungsmittelfrei
solvent free
exento de solvente



abriebfest
abrasion resistant
resistencia a la abrasión
DIN EN ISO 5470-2:
≥ 125 000 Martindale
invers/inverse/inverso



schwer entflammbar
flame protection
resistencia al fuego
EN 1021 (1-2), M2, AM18,
B2, BS 5852 (CRIB5),
FAR 25853, R118, UNI 9175,
CA TB 117-2013, UFAC/
NFPA260 Class1,
IMO FTPC 2010 Part 8



salzwasserbeständig
salt water resistant
resistente al agua salada
DIN EN ISO 9227



antibakteriell/antimikrobiell
antibacterial/antimicrobial
antibacteriano/antimicrobiana



phthalatfrei
phthalate-free
no contiene ftalatos



schweiß-, urin- und blutbeständig
resistant to sudor, blood and urine
resistente al sudor, la orina y la sangre



vegan
vegan
vegan

Anwendung / Verarbeitung

Geeignet für viele Arten von Bepolsterungen und Spannungen in der Polsterindustrie. Besonders geeignet für den Einsatz im trendorientierten Wohn- und Objektbereich, in öffentlichen Gebäuden und Einrichtungen. Problemlose Verarbeitung nach den üblichen Verfahren (Nähen, Heften, Kleben, Nageln). Keine Lösemittelkleber verwenden!

Sonstige Hinweise

Zum Erhalt der Materialeigenschaften Ihres skai® Produktes ist eine regelmäßige Reinigung der Materialoberfläche erforderlich. Benutzen Sie hierzu eine warme, milde Seifenlauge und ein Mikrofaser Tuch oder eine weiche Handbürste. Bitte verwenden Sie keine chemischen Bleichen oder scheuernde Reinigungsmittel. Bitte beachten Sie, dass Anfärbungen des Materials durch Jeans oder andere Textilien von jeglicher Gewährleistung ausgenommen sind.

Besondere Hinweise

Unsere anwendungstechnischen Empfehlungen in Wort und Schrift, die wir aufgrund unserer Erfahrung entsprechend dem aktuellen Kenntnisstand weitergeben, sind unverbindlich und begründen kein Rechtsverhältnis und keine Nebenverpflichtungen aus dem Kaufvertrag. Sie entbinden den Käufer nicht davon, unsere Produkte für den vorgesehenen Verwendungszweck in eigener Verantwortung selbst zu prüfen. Im Übrigen gelten unsere allgemeinen Geschäftsbedingungen. Hiermit verlieren alle früheren, anderslautenden Regelungen ihre Gültigkeit.

Application / Processing

Suitable for many kinds of upholsteries and coverings in the upholstery industry. Especially suitable for the use in the modern residential and contract area, in public buildings and institutions. Problem-free processing in the usual procedures (sewing, tacking, sticking, nailing). Do not use solvent-based adhesives!

Other instructions

To maintain the material properties of your skai® product, it is necessary to regularly clean the material surface. Use a warm, mild soap solution and a microfiber cloth or a soft hand brush for this purpose. Please do not use chemical bleach or abrasive cleaning agents. Please note that staining of the material through jeans or other textiles is excluded from any warranty.

Special notes

Our written and spoken technical recommendations, which we provide based on our experience in accordance with the current state of knowledge, are nonbinding and do not constitute a legal relationship and are not additional obligations from the purchase agreement. They do not release the purchaser from checking our products for the intended use under his own responsibility. Otherwise, our general terms and conditions are in effect. All earlier provisions to the contrary hereby become invalid.

Aplicaciones / Manipulación

Apto para múltiples tipos de tapizado y revestimientos para la industria del mueble tapizado. Especialmente diseñado para el empleo en espacios modernos tanto públicos como privados, en edificios públicos e instituciones. Aplicación sencilla por medio de procedimientos habituales (cosido, hilvanado, pegado, clavado). No usar pegamento disolvente.

Otros consejos

Para conservar las propiedades del material de su producto de skai® es necesario limpiar regularmente la superficie del material. Utilice para ello lejía jabonosa suave y tibia con un paño de microfibra o un cepillo de mano suave. No utilice blanqueadores químicos ni productos de limpieza abrasivos. Tenga en cuenta que las manchas por decoloración en el material causadas por pantalones vaqueros u otros tejidos quedan excluidas de cualquier garantía.

Advertencias especiales

Nuestras recomendaciones técnicas de aplicación, verbales o escritas, que facilitemos sobre la base de nuestra experiencia y de los conocimientos técnicos más actuales, no son vinculantes en ningún caso ni constituyen un compromiso contractual o responsabilidades añadidas al contrato de compraventa. No eximen al comprador de verificar personalmente nuestros productos para el uso previsto y bajo su responsabilidad. En todo lo demás, se aplicarán nuestras condiciones generales, lo que supone la nulidad de cualquier otro acuerdo previo.



* nach den gesetzlichen Bestimmungen prescribed by law de conformidad con las disposiciones legales

REACH

DIN EN ISO 14001
DIN EN ISO 45001
DIN EN ISO 9001
IATF 16949

Interior Living

Contact

Konrad Hornschuch AG
Salinenstraße 1
74679 Weißbach
Germany
Tel. +49 (0)7947 / 81-8714
skai@continental.com
www.skai.com



Benecke-Kaliko S.A.U
Polígono Ind. Landaben C/A, nº 26
31012 Pamplona (Navarra)
Spain

O'Sullivan Films
1944 Valley Avenue
Winchester, Virginia 22601
USA

Der Inhalt dieser Druckschrift ist unverbindlich und dient ausschließlich Informationszwecken. Die dargestellten gewerblichen Schutzrechte sind Eigentum der Continental AG und/oder ihrer Tochtergesellschaften. Copyright © 2023 Continental AG, Hannover. Alle Rechte vorbehalten. Weitere Informationen erhalten Sie unter www.continental-industry.com/disc_l_de

The content of this print is non-binding and serves exclusively Information purposes. The industrial property rights shown are the property of Continental AG and / or its subsidiaries. Copyright © 2023 Continental AG, Hanover. All rights reserved. For further information, please visit www.continental-industry.com/disc_l_en

El contenido de esta publicación no es vinculante y se utiliza exclusivamente. Con fines informativos. Las marcas comerciales mostrados son propiedad de Continental AG y / o sus filiales. Copyright © 2023 ContiTech AG, Hanover. Todos los derechos reservados. Más información está disponible en www.continental-industry.com/disc_l_en