



## skai® Contract Collection 2

Interior

## Information

Empfohlene Einsatzgebiete  
 Technische Daten  
 Flammschutzübersicht  
 IMO-Übersicht  
 Nachhaltigkeitskriterien  
 Desinfektionsmittelempfehlung  
 Reinigung und Pflege

## Information

Fields of application  
 Technical specifications  
 Flame retardant standards  
 IMO overview  
 Sustainability Scorecard  
 Disinfectant recommendation  
 Cleaning and care

## Información

Campos de aplicación  
 Especificaciones técnicas  
 Certificaciones de ignifugación  
 IMO vista de conjunto  
 Criterios de sostenibilidad  
 Recomendaciones para desinfección  
 Limpieza y cuidado

## Innovation

	<b>Made in</b>
skai® Toronto EN	GER
skai® Pureto EN	GER
skai® VyP Nappa, skai® VyP Lana	GER
skai® Mano S	GER

## Leather Design EN

	<b>Made in</b>		<b>Made in</b>
skai® Tovosoft EN	GER	skai® Sorrento EN, skai® Soroma EN	GER
skai® Tovel EN	GER	skai® Sarano	GER
skai® Toledo EN	GER	skai® Kimera EN	ESP
skai® Sotega	GER	skai® Tundra	GER
skai® Sotega Stars	GER		

## Outdoor

	<b>Made in</b>
skai® cool colors Collection	GER
skai® Neptun Collection	GER

## Individual

	<b>Made in</b>
skai® Digital Print	GER

## Exotic Design

	<b>Made in</b>
skai® Soshagro EN	GER
skai® Sofelto EN	GER

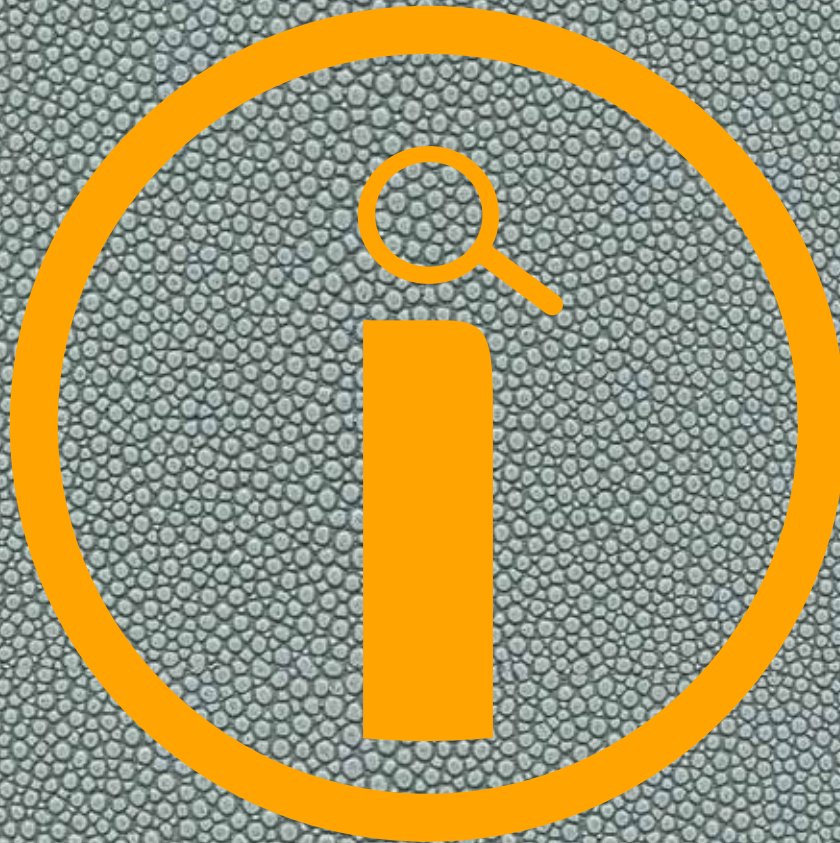

## Information / Information / Información







Empfohlene Einsatzgebiete  
Technische Daten  
Flammschutzübersicht  
IMO-Übersicht  
Nachhaltigkeitskriterien  
Desinfektionsmittelempfehlung  
Reinigung und Pflege

Fields of application  
Technical specifications  
Flame retardant standards  
IMO overview  
Sustainability Scorecard  
Disinfectant recommendation  
Cleaning and care

Campos de aplicación  
Especificaciones técnicas  
Certificaciones de ignifugación  
IMO vista de conjunto  
Criterios de sostenibilidad  
Recomendaciones para desinfección  
Limpieza y cuidado

## skai® Contract Collection 2

Empfohlene Einsatzgebiete / Fields of applications / Ámbitos de aplicación recomendados

Register Register Registro	Artikel Article Artículo						
		Public Area	Hospitality	Residential	Healthcare	Fitness	Outdoor/ Marine Application
<b>Innovation</b>	skai® Toronto EN	●	●	●	●	●	
	skai® Pureto EN	●	●	●			
	skai® VyP Lana	●	●	●			
	skai® VyP Nappa	●	●	●			
	skai® Mano S	●					
<b>Leather Design EN</b>	skai® Tovosoft EN	●	●	●	●	●	
	skai® Tovel EN	●	●	●	●	●	
	skai® Toledo EN	●	●	●	●	●	
	skai® Sotega	●	●	●			
	skai® Sotega Stars		●	●			
	skai® Sorrento EN	●	●	●			
	skai® Soroma EN	●	●	●			
	skai® Sarano		●	●			
	skai® Kimera EN	●	●	●	●	●	
	skai® Tundra	●	●	●	●	●	
	skai® Tundra	●	●	●	●	●	
<b>Outdoor</b>	skai® cool colors Collection	●	●	●	●	●	●
	skai® Neptun Collection	●	●	●	●	●	●
<b>Individual</b>	skai® Digital Print - Pandoria base		●	●			
	skai® Digital Print - Toledo EN base		●	●			
<b>Exotic Design</b>	skai® Soshagro EN		●	●			
	skai® Sofelto EN		●	●			



## skai® Contract Collection 2

Technische Daten / Technical specifications / Datos técnicos

Register Register Registro	Artikel Article Articulo	Gewicht Weight Peso	Dicke (mm) Thickness (mm) Espesor (mm)	Martindale (DIN EN ISO 5470-2) Abrieb invers Abrasion inverse Abrasión inverso	Abrieb (Wyzenbeek) Abrasion (Wyzenbeek) Abrasión (Wyzenbeek)	Warenbreite Roll width Ancho de rollo	Rollenlänge Length of roll Largo de rollo	Schwer entflammbar Flame retardant Retardante de llama	phthalatfrei phthalate-free no contiene ftalatos	lösemittelfreies Finish solvent-free finish exento de solvente	
<b>Innovation</b>	skai® Toronto EN	740 +/- 50 g/m <sup>2</sup>	1.3 +/- 0.2 mm	300 000		140 cm	30 m	●	●	●	
	skai® Pureto EN	640 +/- 50 g/m <sup>2</sup>	1.2 +/- 0.2 mm	100 000	100 000	140 cm	30 m	●	●	●	
	skai® VyP Lana	720 +/- 50 g/m <sup>2</sup>	1.4 +/- 0.2 mm	100 000		140 cm	30 m	●	●	●	
	skai® VyP Nappa	720 +/- 50 g/m <sup>2</sup>	1.4 +/- 0.2 mm	100 000	100 000	140 cm	30 m	●	●	●	
	skai® Mano S	650 +/- 50 g/m <sup>2</sup>	1.15 +/- 0.2 mm			137 cm	30 m				
<b>Leather Design EN</b>	skai® Tovosoft EN	740 +/- 50 g/m <sup>2</sup>	1.1 +/- 0.2 mm	150 000		140 cm	30 m	●	●	●	
	skai® Tovel EN	740 +/- 50 g/m <sup>2</sup>	1.3 +/- 0.2 mm	150 000		140 cm	30 m	●	●	●	
	skai® Toledo EN	740 +/- 50 g/m <sup>2</sup>	1.4 +/- 0.2 mm	200 000		140 cm	30 m	●	●		
	skai® Sotega	780 +/- 50 g/m <sup>2</sup>	1.65 +/- 0.2 mm	200 000		150 cm	30 m			●	
	skai® Sotega Stars	795 +/- 50 g/m <sup>2</sup>	1.7 +/- 0.2 mm	50 000		150 cm	30 m			●	
	skai® Sorrento EN	780 +/- 50 g/m <sup>2</sup>	1.6 +/- 0.2 mm	100 000		150 cm	30 m	●		●	
	skai® Soroma EN	780 +/- 50 g/m <sup>2</sup>	1.6 +/- 0.2 mm	50 000		150 cm	30 m	●		●	
	skai® Sarano	600 +/- 50 g/m <sup>2</sup>	1.45 +/- 0.2 mm	75 000		150 cm	30 m	●		●	
	skai® Kimera EN	630 +/- 50 g/m <sup>2</sup>	1.1 +/- 0.2 mm	100 000	50 000	140 cm	30 m	●		●	
	skai® Tundra	680 +/- 50 g/m <sup>2</sup>	1.0 +/- 0.2 mm	100 000 (silber: 5 000)		137 cm	30 m		●		
	<b>Outdoor</b>	skai® cool colors Collection	640 +/- 60 g/m <sup>2</sup>	1.35 +/- 0.2 mm	100 000	100 000	140 cm	30 m	●		
		skai® Neptun Collection	860 +/- 60 g/m <sup>2</sup>	1.15 +/- 0.2 mm	300 000		140 cm	30 m	●		
<b>Individual</b>	skai® Digital Print - Pandoria base	730 +/- 50 g/m <sup>2</sup>	1.2 +/- 0.2 mm	50 000		137 cm	30 m	●			
	skai® Digital Print - Toledo EN base	610 +/- 50 g/m <sup>2</sup>	1.2 +/- 0.2 mm	30 000		137 cm	30 m	●			
<b>Exotic Design</b>	skai® Soshagro EN	780 +/- 50 g/m <sup>2</sup>	1.75 +/- 0.2 mm	75 000	50 000	150 cm	30 m	●		●	
	skai® Sofelto EN	810 +/- 50 g/m <sup>2</sup>	1.6 +/- 0.2 mm	100 000	50 000	150 cm	30 m	●		●	



## skai® Contract Collection 2

Flammschutzübersicht / Flame retardants standards / Certificaciones de resistencia al fuego



Register Register Registro	Norm Norme	DIN EN 1021-1/-2	BS 5852 IS O+1	IMO FTPC 2010 Part 8	MVSS302	DIN 4102-1	NF P 92- 503	UNE 23 727-90	CA TB 117-2013 Section 1	UFAC Method 1990 / NFPA 260-19	ASTM E84
	Klassifizierung Class Classe	Pass	Pass	Pass		B2	M2	M2	Cigarette Pass	Cigarette Pass	"Tunnel test" Class A
Artikel Article Articulo											
<b>Innovation</b>	skai® Toronto EN	●	●	●	●				●	●	
	skai® Pureto EN	●	●	●	●				●	●	
	skai® VyP Lana	●	●	●	●				●	●	
	skai® VyP Nappa	●	●	●	●				●	●	
	skai® Mano S										
<b>Leather Design EN</b>	skai® Tovosoft EN	●	●	●	●						
	skai® Tovel EN	●	●	●	●				●	●	
	skai® Toledo EN	●	●	●	●				●	●	
	skai® Sotega								●	●	
	skai® Sotega Stars								●	●	
	skai® Sorrento EN	●	●	●	●				●	●	
	skai® Soroma EN	●	●	●	●				●	●	
	skai® Sarano	●	●								
	skai® Kimera EN	●	●		●				●	●	
	skai® Tundra								●	●	
<b>Outdoor</b>	skai® cool colors Collection	●	●	●					●	●	
	skai® Neptun Collection	●	●	●							
<b>Individual</b>	skai® Digital Print - Pandoria base	●	●	●	●	●	●				●
	skai® Digital Print - Toledo EN base	●	●		●						
<b>Exotic Design</b>	skai® Soshagro EN	●	●	●	●				●	●	
	skai® Sofelto EN	●	●	●	●				●	●	



© NCL

**skai® Cruise Ship Products**  
Contract Collection 2

# Impressionen / Impressions / Impresiones



## Schiffe / Ships / Barcos

Carnival Vista  
Carnival Horizon  
Costa Favolosa  
Costa Fortuna  
Costa Magica  
Cunard Queen Elizabeth  
Cunard Line Queen Mary II  
Disney Dream  
Disney Fantasy  
Genting Dream  
Marella Explorer 2  
MSC Preziosa  
MSC Poesia  
MSC Seaview  
MSC Sinfonia  
MSC Armonia

MSC Fantasia  
MSC Rhapsody  
MSC Meraviglia  
Norwegian Bliss  
Norwegian Breakaway  
Norwegian Getaway  
Norwegian Escape  
Norwegian Joy  
P&O Cruises Britannia  
P&O Cruises Pacific Explorer  
P&O Orania  
Ponant Le Champlain  
Ponant Le Lapérouse  
Royal Caribbean Oasis of the Sea  
Royal Caribbean Quantum of the Seas  
Royal Caribbean Anthem of the Seas

Royal Caribbean Ovation of the Seas  
Royal Caribbean Symphony of the Seas  
Saga Spirit of Adventure  
Saga Spirit of Discovery  
Silversea Silver Muse  
Silversea Silver Cloud  
Silversea Silver Galapagos  
Silversea Silver Shadow  
Silversea Silver Spirit  
TUI Mein Schiff 3  
TUI Mein Schiff 4  
TUI Mein Schiff 5  
Viking Orion  
Viking Sun



# IMO FTPC P8



Register Register Registro	Artikel Article Artículo	 0161/2023	IMO FTPC 2010 Part 8
<b>Innovation</b>	skai® Toronto EN	●	●
	skai® Pureto EN	●	●
	skai® VyP Lana	●	●
	skai® VyP Nappa	●	●
<b>Leather Design EN</b>	skai® Tovosoft EN		●
	skai® Tovel EN	●	●
	skai® Toledo EN	●	●
	skai® Sorrento EN	●	●
	skai® Soroma EN	●	●
<b>Outdoor</b>	skai® cool colors Collection	●	●
	skai® Neptun Collection	●	●
<b>Individual</b>	skai® Digital Print - Pandoria base	●	●
<b>Exotic Design</b>	skai® Soshagro EN	●	●
	skai® Sofelto EN	●	●

Conformity: 0161 = Notified body number.

Alle Artikel, welche aktuell nicht in schwer entflammbarer Ausrüstung angeboten werden, können mit einer Mindestmenge von 700 lfm in IMO-Version gefertigt werden.

All articles that are currently not available in flameresistant equipment, can be produced in a minimum of 700 rm in IMO-version.

Todos los artículos que no se ofrecen actualmente como equipos ignífugos, se pueden fabricar en una cantidad mínima de 700 m/lineales, en la versión IMO.

**Continental**   
The Future in Motion

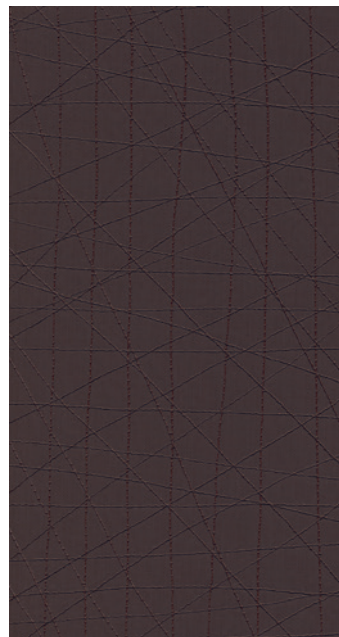
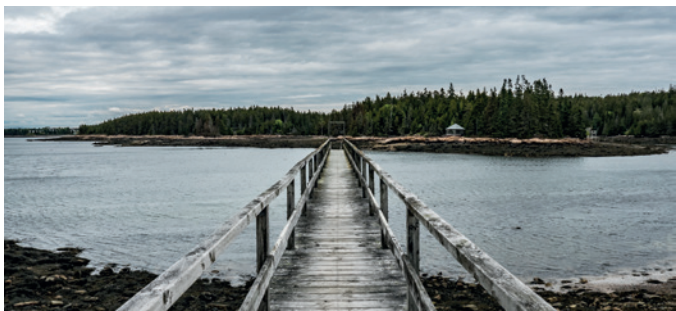
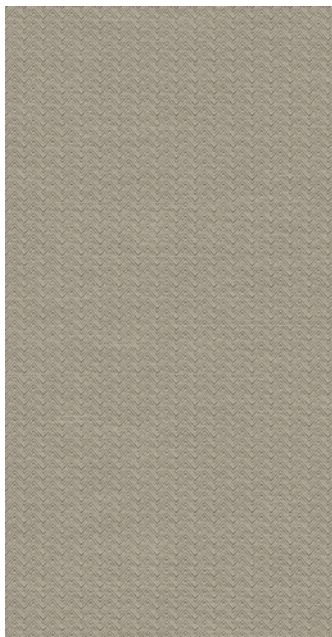
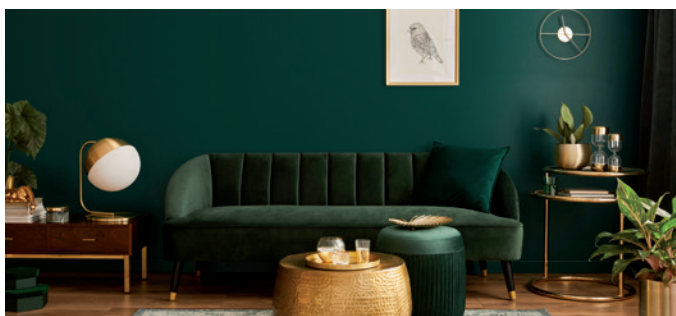

## skai® Nachhaltigkeitskriterien

So nachhaltig sind die skai® Polsterbezugsstoffe

## skai® Sustainability Scorecard

This is why the skai® upholstery fabrics are sustainable

Contract Collection 02





# Nachhaltigkeitskriterien

So nachhaltig sind die skai® Polsterbezugstoffe  
(07/2023)



# Sustainability Scorecard

This is why the skai® upholstery fabrics are sustainable  
(07/2023)

	Contract Collection O2	Innovation					Leather Design EN										Outdoor			Individual - skai® digital print		Exotic Design		
	Artikel Article	skai® Toronto EN	skai® Pureto EN	skai® VyP Nappa	skai® VyP Lana	skai® Mano S	skai® Tovosoft EN	skai® Tovel EN	skai® Toledo EN	skai® Sotega	skai® Sotega Stars	skai® Sorrento EN*	skai® Soroma EN*	skai® Sarano	skai® Kimera EN	skai® Tundra	skai® cool colors	skai® Neptun	skai® Marea	Pandoria base	Toledo EN base	skai® Soshagro EN*	skai® Sofelto EN*	
<b>Inhaltsstoffe Contents</b>	Phthalatfrei Phthalate-free	•	•	•	•		•	•	•		•	•	•			•						•	•	
	Einsatz nachwachsender Rohstoffe Use of renewable raw materials	•	•	•	•		•	•	•	•	•	•	•	•		•							•	•
	Einsatz von Weichmachern auf Basis nachwachsender Rohstoffe Use of plasticizers based on renewable raw materials	•		•	•		•	•	•		•	•	•			•							•	•
	Einsatz von Bio-Baumwolle oder recycelten PES-Fasern Use of organic cotton or recycled PES fibers						•						•											
	Lösemittelfreies Finish Solvent-free finish	•	•	•	•		•	•		•	•	•	•	•	•				•				•	•
Einsatz mineralischer Füllstoffe & Flammschutzmittel Use of mineral fillers & flame retardants	•					•	•	•		•	•				•						•	•	•	
<b>Prozess Process</b>	100% CO <sub>2</sub> -neutraler Strom 100% CO <sub>2</sub> -neutral electricity	•	•	•	•	•	•	•	•	•	•	•	•	•	•	•	•	•	•	•	•	•	•	
	Reduzierter Energieeinsatz im Prozess Reduced energy usage in the process	•	•	•	•																			
	Fertigstellung / Produktion an einem Standort Completion/production at one location	•	•	•	•	•	•	•	•	•	•	•	•	•	•	•	•	•	•	•	•	•	•	
	In-House-Recycling In-house recycling	•	•	•	•	•	•	•	•	•	•	•	•	•	•	•	•	•	•	•	•	•	•	
	Einsatz lokaler (DE) / regionaler (EU) Rohstoffe Use of local (GER) / regional (EU) raw materials	•	•	•	•	•	•	•	•	•	•	•	•	•	•	•	•	•	•	•	•	•	•	
<b>Eigenschaften Properties</b>	Langlebigkeit Durability	•	•	•	•	•	•	•	•	•	•	•	•	•	•	•	•	•	•	•	•	•	•	
	Ökotex-Zertifizierung Ökotex certification																							
	Medizinproduktegesetz / Biokompatibilität Medical Devices Act / Biocompatibility	•							•							•								
	PAK-Freiheit entsprechend der GS-Vorgaben Absence of PAH in accordance with GS specifications	•	•	•	•	•	•	•	•	•	•	•	•	•	•	•	•	•	•	•	•	•	•	
	Spielzeugnorm EN 71-3 Toy standard EN 71-3		•																					
	Emission / CE-Konformität nach Baurecht Emission / CE conformity according to building law																							

\* Produktionscharge größer als 100367000 | Lot number higher than 100367000

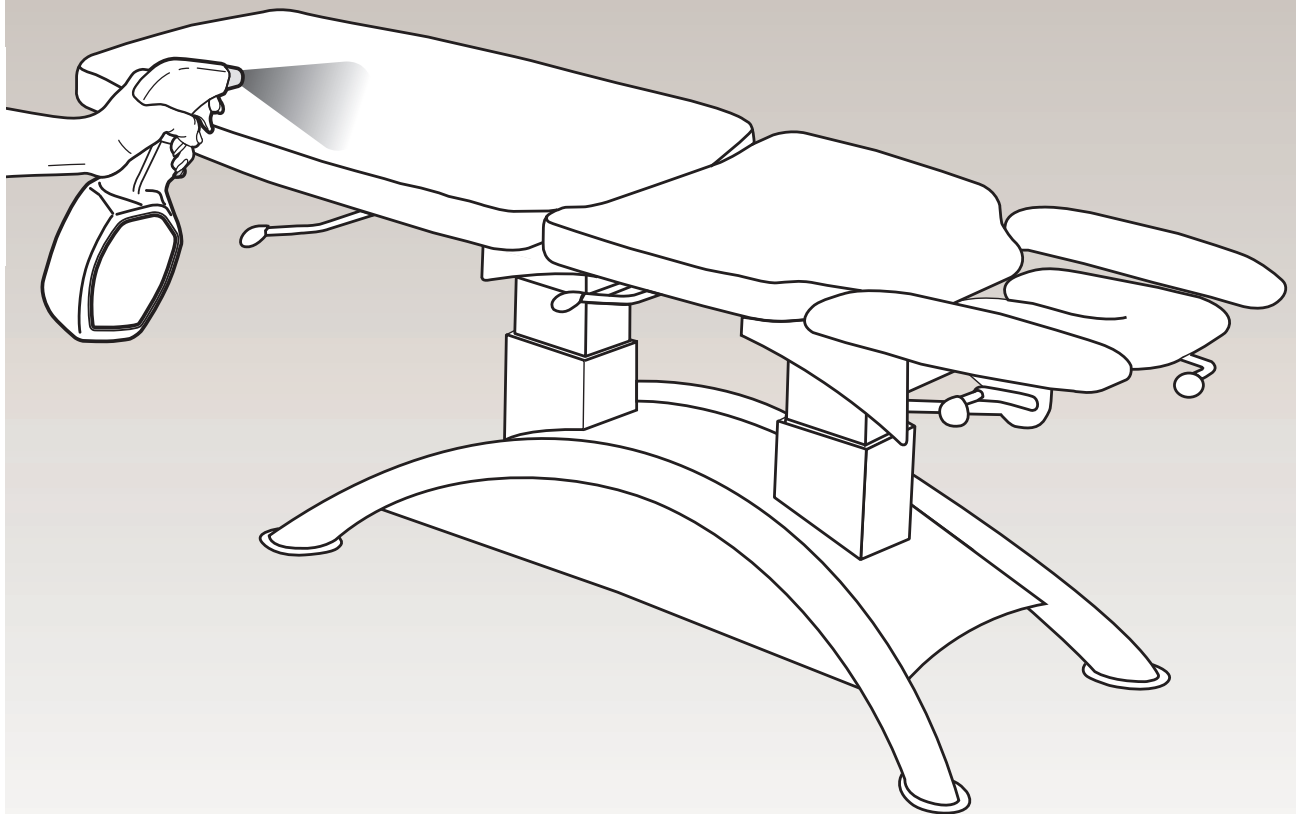

## **skai<sup>®</sup> Desinfektionsmittelempfehlung**

skai<sup>®</sup> Disinfectant recommendation

skai<sup>®</sup> Recomendación de desinfectantes

Effectiveness  
against  
SARS-CoV-2



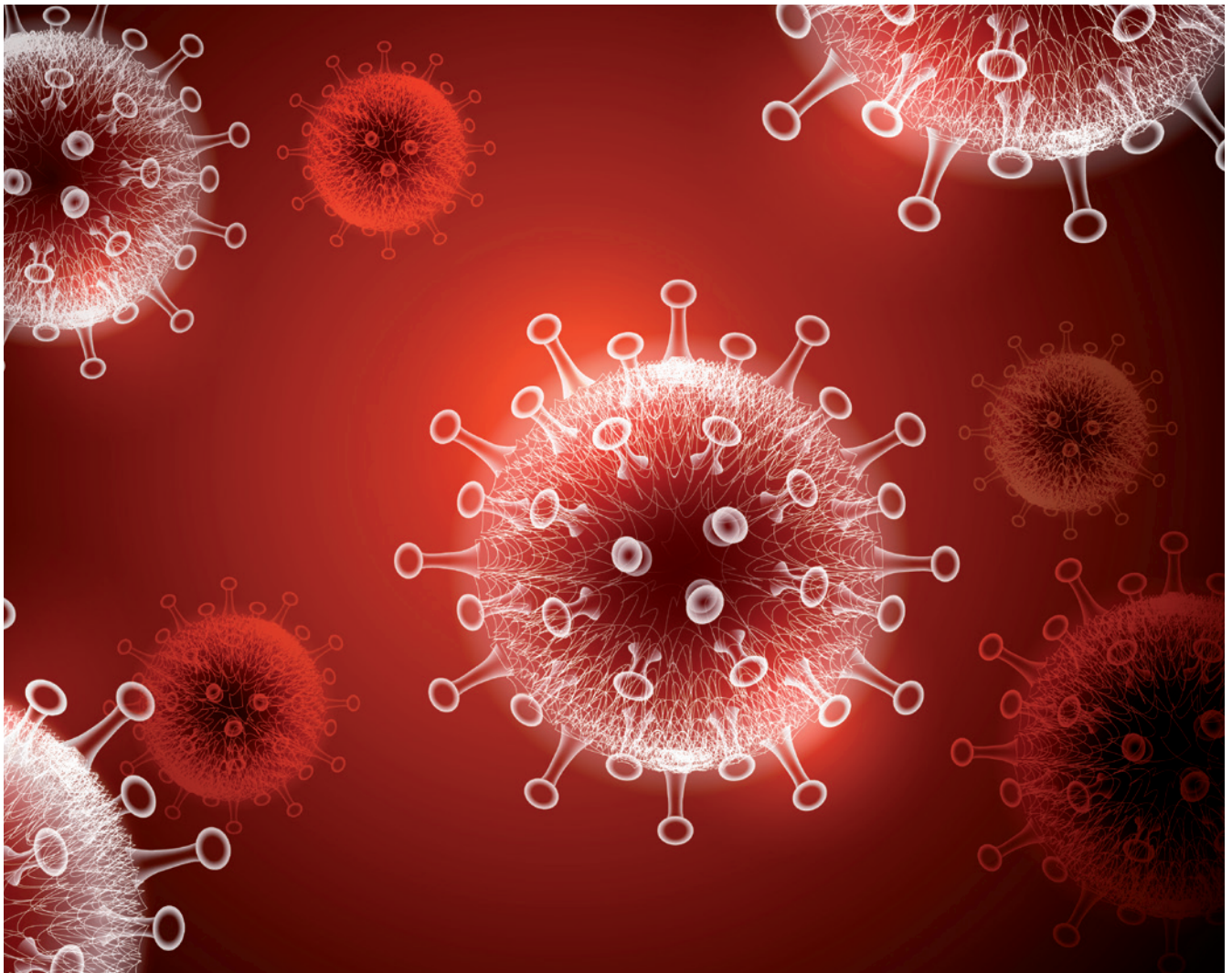

## Reinigung und Pflege skai® Polster- und Modematerialien

Zum Erhalt der Materialeigenschaften Ihres skai® Produktes ist eine regelmäßige Reinigung der Materialoberfläche erforderlich. Benutzen Sie hierzu eine warme, milde Seifenlauge und ein Mikrofasertuch. Bei stärkeren Verschmutzungen kann auch eine weiche Handbürste verwendet werden.

Verschmutzungen durch Öle, Fette, stark färbende Lebensmittel oder andere Substanzen müssen umgehend entfernt werden. Der Reinigungsvorgang muss bei starken Verunreinigungen unter Umständen wiederholt werden. Bitte berücksichtigen Sie bei der Verwendung von handelsüblichen Tensid-Reinigern stets die Dosierungsanleitung des jeweiligen Herstellers.

Eine regelmäßige Reinigung Ihres skai® Produktes ist zum Erhalt der Lebensdauer ausreichend. Eine zusätzliche Behandlung z.B. mit Lederpflegemitteln ist nicht erforderlich.

Bitte verwenden Sie keine chemischen Bleichen oder scheuernde Reinigungsmittel.

Bitte beachten Sie, dass Anfärbungen des Materials durch Jeans oder andere Textilien von jeglicher Gewährleistung ausgenommen sind.

## Cleaning and care skai® upholstery and fashion materials

To maintain the material properties of your skai® product, it is necessary to regularly clean the material surface. Use a warm, mild soap solution and a microfiber cloth for this purpose. A soft hand brush can also be used for heavier soiling.

Soiling due to oils, greases, highly-staining foods or other substances must be removed immediately. The cleaning process may have to be repeated in the event of heavy soiling. Please always observe the relevant manufacturer's dosage instructions when using commercially available surfactant cleaning agents.

Regular cleaning of your skai® product is sufficient to maintain its service life. No additional treatment, for example using leathercare products, is necessary. Please do not use any chemical bleaches or abrasive cleaning agents.

Please note that staining of the material through jeans or other textiles is excluded from any warranty.

## Limpieza y cuidado de los materiales de tapizado y de moda de skai®

Para conservar las propiedades del material de su producto de skai® es necesario limpiar regularmente la superficie del material. Para ello, utilice lejía jabonosa caliente y suave y un paño de microfibra. Para la suciedad más incrustada también puede utilizarse un cepillo de mano suave.

La suciedad causada por aceites, grasas, alimentos u otras sustancias de fuerte coloración debe eliminarse inmediatamente. Es posible que haya que repetir el proceso de limpieza en caso de que exista suciedad severa. Siga siempre las instrucciones de dosificación del fabricante cuando utilice limpiadores con surfactantes convencionales.

La limpieza regular de su producto de skai® es suficiente para mantener la vida útil. No es necesario un tratamiento adicional, por ejemplo, con productos para el cuidado del cuero. No utilice blanqueadores químicos ni productos de limpieza abrasivos.

Tenga en cuenta que las manchas por decoloración en el material causadas por pantalones vaqueros u otros tejidos quedan excluidas de cualquier garantía.

**Continental**   
The Future in Motion



Innovation



**Innovation**



**Continental**   
The Future in Motion



reddot winner 2021



**GERMAN  
INNOVATION  
AWARD '21  
WINNER**

**skai<sup>®</sup> Toronto EN**  
Innovation

Excellent  
stain resistance  
—  
**NEW**  
colors 2022

**staynu**



# Toronto EN



Hochwertiges skai® Polstermaterial für viele Anwendungen, vor allem im Objektbereich. Seine klassische Lederprägung wertet Möbel und Wände auf. Dank innovativer Finishierung mit der skai® staynu Technologie ist das Material hoch fleckunempfindlich und sehr reinigungsfreundlich. So bleibt seine Optik über lange Zeit in Bestform - egal was passiert.

High-quality skai® upholstery material for many applications, especially in the contract area. Its classic leather grain enhances furniture and walls. Thanks to innovative finishing with skai® staynu technology, the material is highly stain-resistant and very easy to clean. This keeps its visual appearance in top form for a long time - no matter what happens.

Material de tapicería de alta calidad de skai® para diversas aplicaciones, especialmente en el sector de las áreas públicas. Su grano de cuero clásico realza el mobiliario y las paredes. Gracias al innovador acabado con la tecnología skai® staynu, el material es muy resistente a las manchas y muy fácil de limpiar. Esto mantiene su aspecto visual como el primer día durante mucho tiempo, sin importar lo que pase.

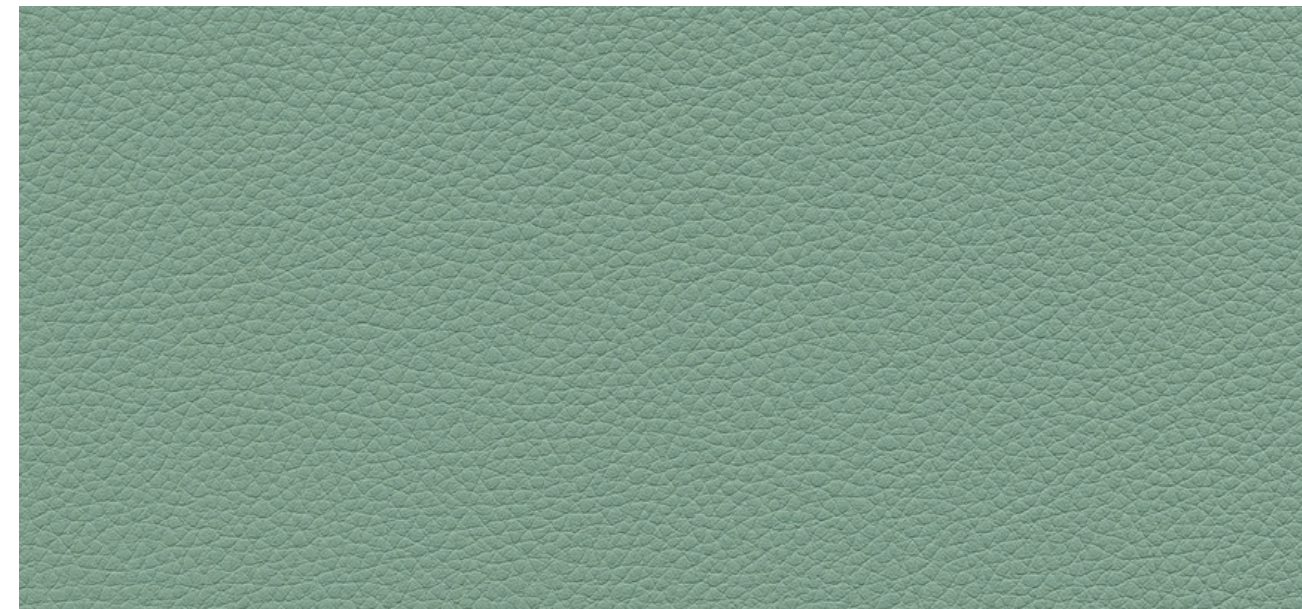

skai® Toronto EN sage F6471024



white F6471002



pearl F6471003



ashgrey F6471011



birch F6471004



nougat F6471025



rosé F6471026



# skai® Toronto EN

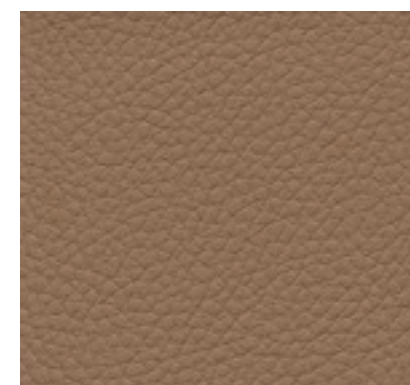

cappuccino F6471005

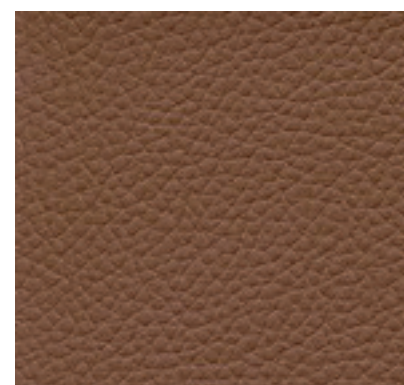

chestnut F6471007

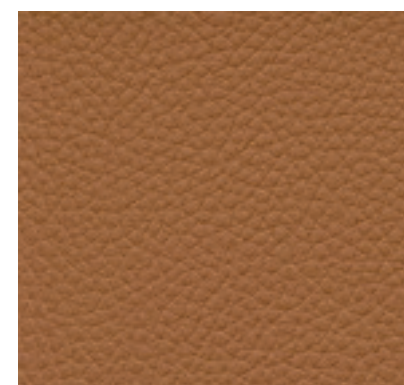

cashmere F6471006

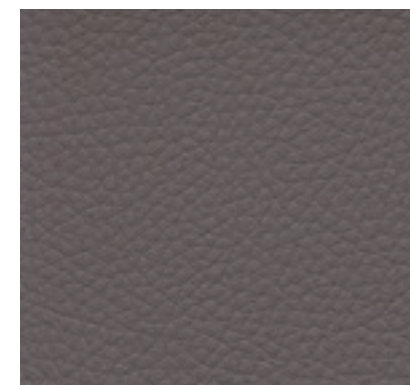

carob F6471009



mocca F6471010

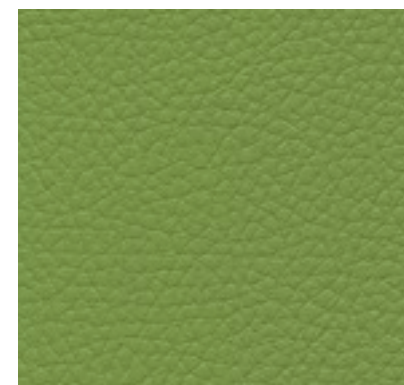

olive green F6471014

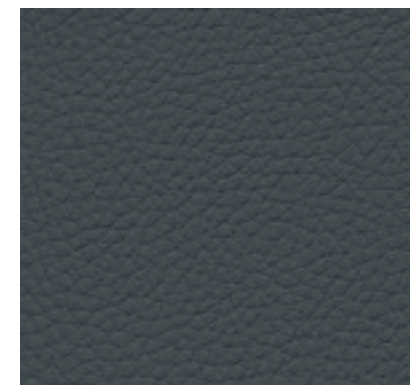

anthracite F6471015

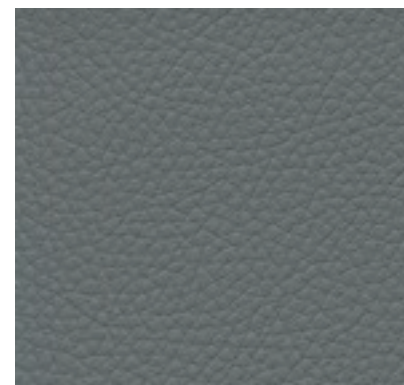

slate grey F6471012

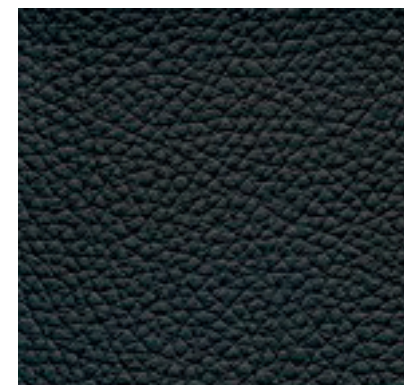

black F6471016

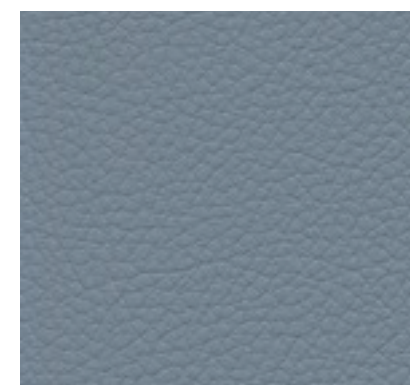

stone blue F6471001

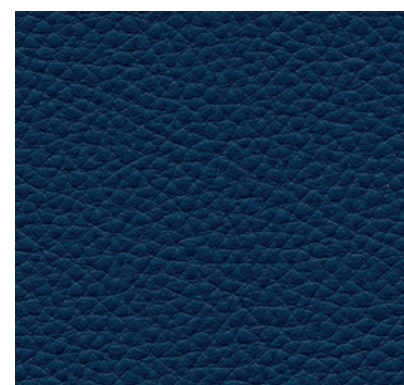

deep sea F6471018

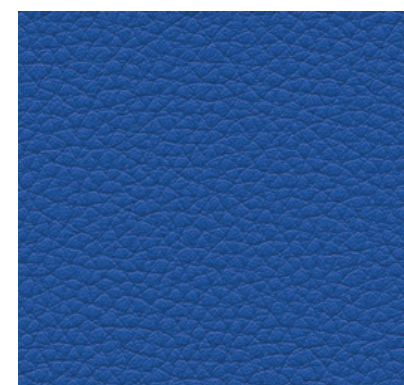

atoll F6471021



# skai® Toronto EN

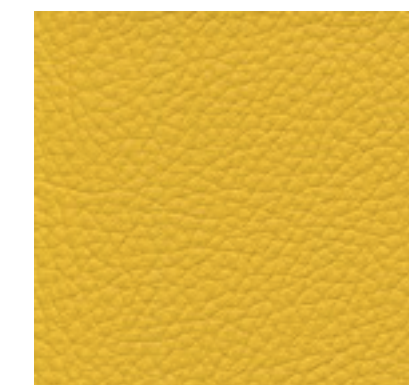

corn F6471013

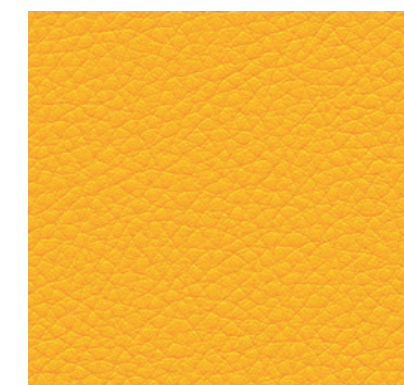

sun F6471023

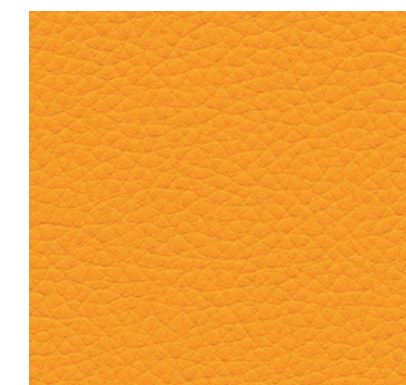

orange F6471022

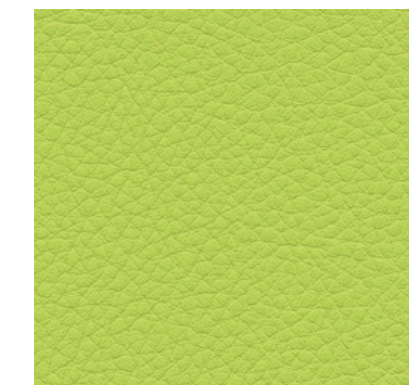

lime F6471019

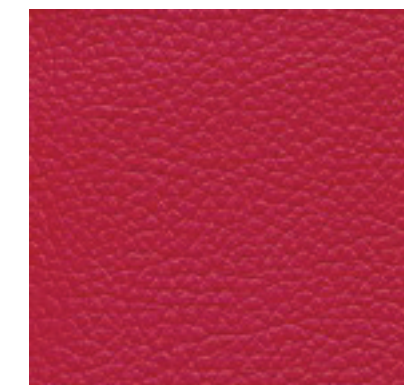

cherry F6471008



fire F6471020



## staynu

### Reinigung und Pflege der Materialoberfläche von skai® Toronto EN

Zum Erhalt der Materialeigenschaften von skai® Toronto EN ist eine regelmäßige Reinigung der Materialoberfläche erforderlich. Benutzen Sie hierzu den skai® Reiniger oder eine warme, milde Seifenlauge und ein Mikrofasertuch. Verschmutzungen durch stark färbende Lebensmittel oder andere Substanzen müssen umgehend entfernt werden. Bei hartnäckigen Verschmutzungen wie Kugelschreiber, Permanentmarker etc. kann die Materialoberfläche Ihres skai® Toronto EN Produktes zusätzlich mit alkoholbasierten Reinigern, wie beispielsweise Isopropanol oder Spiritus, gereinigt werden. Rückstände an alkoholischen Reinigungsmitteln sowie Seifenrückständen müssen im Anschluss mit einem feuchten Tuch und lauwarmem Wasser entfernt werden. Eine regelmäßige Reinigung des skai® Toronto EN Produktes ist zum Erhalt der Lebensdauer ausreichend. Eine zusätzliche Behandlung z. B. mit Lederpflegemitteln ist nicht erforderlich. Bitte verwenden Sie keine chemischen Bleichen oder scheuernde Reinigungsmittel.

### Cleaning and care of the material surface of skai® Toronto EN

In order to maintain the material properties of skai® Toronto EN, regular cleaning of the material surface is required. For cleaning, please use skai® cleaning agent or a warm, mild soapy water and a microfiber cloth. Soiling caused by color bleeding groceries or other substances must be removed immediately. In the case of persistent soiling, the material surface of your skai® Toronto EN product can also be cleaned with alcohol-based cleaners, such as isopropanol or ethanol. Residues of alcoholic cleaning agents or soap must then be removed with a damp cloth and lukewarm water. Regular cleaning of the skai® Toronto EN product is sufficient to maintain the product lifetime. Additional treatment e.g. with leather care products is not necessary. Please do not use chemical bleaches or abrasive cleaning agents.

### Limpeza y cuidado de la superficie del material de skai® Toronto EN

Para mantener las propiedades de los materiales de skai® Toronto EN, es necesario limpiar regularmente la superficie del material. Para ello, utilice skai® limpiador o agua jabonosa caliente y suave y un paño de microfibra. La suciedad causada por alimentos u otras sustancias de fuerte coloración debe eliminarse inmediatamente. En caso de suciedad resistente como bolígrafos, rotuladores permanentes, etc., la superficie del material de su producto skai® Toronto EN también puede limpiarse con productos a base de alcohol, como isopropanol o alcohol de quemar. Los restos de productos de limpieza alcoholizados y los restos de jabón se deben eliminar después con un paño húmedo y agua tibia. La limpieza regular del producto skai® Toronto EN es suficiente para mantener la vida útil. No es necesario un tratamiento adicional, por ejemplo, con productos para el cuidado del cuero. No utilice blanqueadores químicos ni productos de limpieza abrasivos.



Public Area



Hospitality



Residential



Healthcare



Fitness

**Materialzusammensetzung:**

ca. 84 % PVC-Compound  
ca. 16 % PES-Gestrick  
**Gewicht:** 740 +/- 50 g/m<sup>2</sup>  
**Dicke:** 1,3 +/- 0,2 mm  
**Rollenbreite:** 140 cm  
**Rollenlänge:** 30m

**Material composition:**

approx. 84 % PVC-compound  
approx. 16 % PES-knitted fabric  
**Weight:** 740 +/- 50 g/m<sup>2</sup>  
**Thickness:** 1.3 +/- 0.2 mm  
**Roll width:** 140cm  
**Roll length:** 30m

**Composición del material:**

aprox. 84 % compuesto de PVC  
aprox. 16 % soporte textil de punto de PES  
**Peso:** 740 +/- 50 g/m<sup>2</sup>  
**Espesor:** 1,3 +/- 0,2 mm  
**Ancho de rollo:** 140cm  
**Largo de rollo:** 30m



langlebig  
long-lasting  
larga vida útil



reißfest  
tear resistant  
resistente al desgarro



abriebfest  
abrasion resistant  
resistencia a la abrasión  
**DIN EN ISO 5470-2:**  
**≥ 300 000 Martindale**  
invers/inverse/inverso



schwer entflammbar  
flame protection  
resistencia al fuego  
**DIN EN 1021-1+2,**  
**BS 5852 IS-O+1, MVSS302**



pflegeleicht  
easy to clean  
fácil mantenimiento



lichtecht  
lightfast  
resistencia a la luz  
**DIN EN ISO 105-BS02,**  
**Stufe 6, level 6, nivel 6**



weich und dehnfähig  
soft and stretchable  
suave y elástico



**0161/2023**  
IMO FTPC 2010 Part 8



desinfektionsmittelbeständig  
disinfectant resistant  
resistente a los  
desinfectantes



öl- und fettbeständig  
resistant to oil and fat  
resistente a aceites y grasas



phthalatfrei  
phthalate-free  
no contiene ftalatos



erfüllt Medizinproduktegesetz  
fulfills medical standard  
cumple la normativa para  
productos sanitarios  
DIN EN ISO 10993-5+10



schweiß-, urin- und  
blutbeständig  
resistant to sudor,  
blood and urine  
resistente al sudor, la  
orina y la sangre



lösungsmittelfrei  
solvent free  
exento de solvente



nachhaltig  
sustainable  
sostenible



vegan  
vegan  
vegano

**Anwendung / Verarbeitung**

Geeignet für viele Arten von Bepolsterungen und Spannungen in der Polsterindustrie. Besonders geeignet für den Einsatz im trendorientierten Wohn- und Objektbereich, in öffentlichen Gebäuden und Einrichtungen. Problemlose Verarbeitung nach den üblichen Verfahren (Nähen, Heften, Kleben, Nageln). Keine eingefärbten Kleber oder Lösemittelkleber verwenden!

**Besondere Hinweise**

Unsere anwendungstechnischen Empfehlungen in Wort und Schrift, die wir aufgrund unserer Erfahrung entsprechend dem aktuellen Stand der Technik weitergeben, sind unverbindlich. Sie entbinden den Käufer nicht davon, die Eignung unsere Produkte für den vorgesehenen Verwendungszweck in eigener Verantwortung selbst zu prüfen. Dies gilt insbesondere für alle Komponenten, die zusammen mit unserem Produkt verarbeitet werden und deren Verträglichkeit im Verbund. Im Übrigen gelten unsere allgemeinen Geschäftsbedingungen. Hiermit verlieren alle früheren, anderslautenden Regelungen ihre Gültigkeit.

**Application / Processing**

Suitable for many kinds of upholsteries and coverings in the upholstery industry. Especially suitable for the use in the modern residential and contract area, in public buildings and institutions. Problem-free processing in the usual procedures (sewing, tacking, sticking, nailing). Do not use colored adhesives or solvent adhesives!

**Special notes**

Our spoken and written application engineering recommendations, which we pass on based on our experience and in accordance with the current state of the art, are non-binding. They do not absolve buyers of their own responsibility to check the suitability of our products for the intended purpose. This applies in particular to all components that are processed together with our product and their compatibility in combination with each other. Otherwise, our general terms and conditions are in effect. All earlier provisions to the contrary hereby become invalid.

**Aplicaciones / Manipulación**

Adecuado para numerosos tipos de tapizados y revestimientos en el sector de la tapicería. Especialmente adecuado para su uso en el ámbito residencial exclusivo y de tendencia y en instalaciones y edificios públicos. Aplicación sencilla por medio de procedimientos habituales (cosido, hilvanado, pegado, clavado). ¡No utilizar adhesivos tintados ni a base de disolventes!

**Advertencias especiales**

Las recomendaciones de aplicaciones técnicas que ofrecemos, ya sea de palabra o por escrito, en base a nuestra experiencia y conforme a los avances tecnológicos actuales, no son vinculantes. En ningún caso eximirán al comprador de comprobar por sí mismo y bajo su propia responsabilidad la idoneidad de nuestros productos para la finalidad de uso prevista. Esto se aplica especialmente para todos aquellos componentes que se utilicen junto con nuestro producto y su compatibilidad al combinarlos. En todo lo demás, se aplicarán nuestras condiciones generales, lo que supone la nulidad de cualquier otro acuerdo previo.



\* nach den gesetzlichen Bestimmungen prescribed by law de conformidad con las disposiciones legales



**Continental**   
The Future in Motion



**skai® Pureto EN**  
Innovation



skai® Pureto EN ist ein hochwertiger PVC-freier Polsterbezug für den Hospitality-, Office-, und Public Area-Bereich. Das nachhaltige Material wird mit einem sehr robusten Polyurethan-System produziert, das wasserbasiert und somit lösmittelfrei ist. Die Oberfläche ähnelt Kalbsleder, hat eine weiche Haptik und ist in unterschiedlichen Farben erhältlich.

skai® Pureto EN is a high-quality PVC-free upholstery material for the hospitality, office, and public area sectors. The sustainable material is produced using a very robust polyurethane system, which is water-based and therefore solvent-free. The surface resembles calfskin, has a soft feel, and is available in different colors.

skai® Pureto EN es una tela de alta calidad para tapicería de acolchados sin PVC para los sectores de la hostelería, la oficina y las áreas públicas. El material sostenible se produce con un sistema de poliuretano muy robusto, a base de agua y, por lo tanto, sin disolventes. La superficie se asemeja a la piel de vaca, tiene un tacto suave y está disponible en diferentes colores.

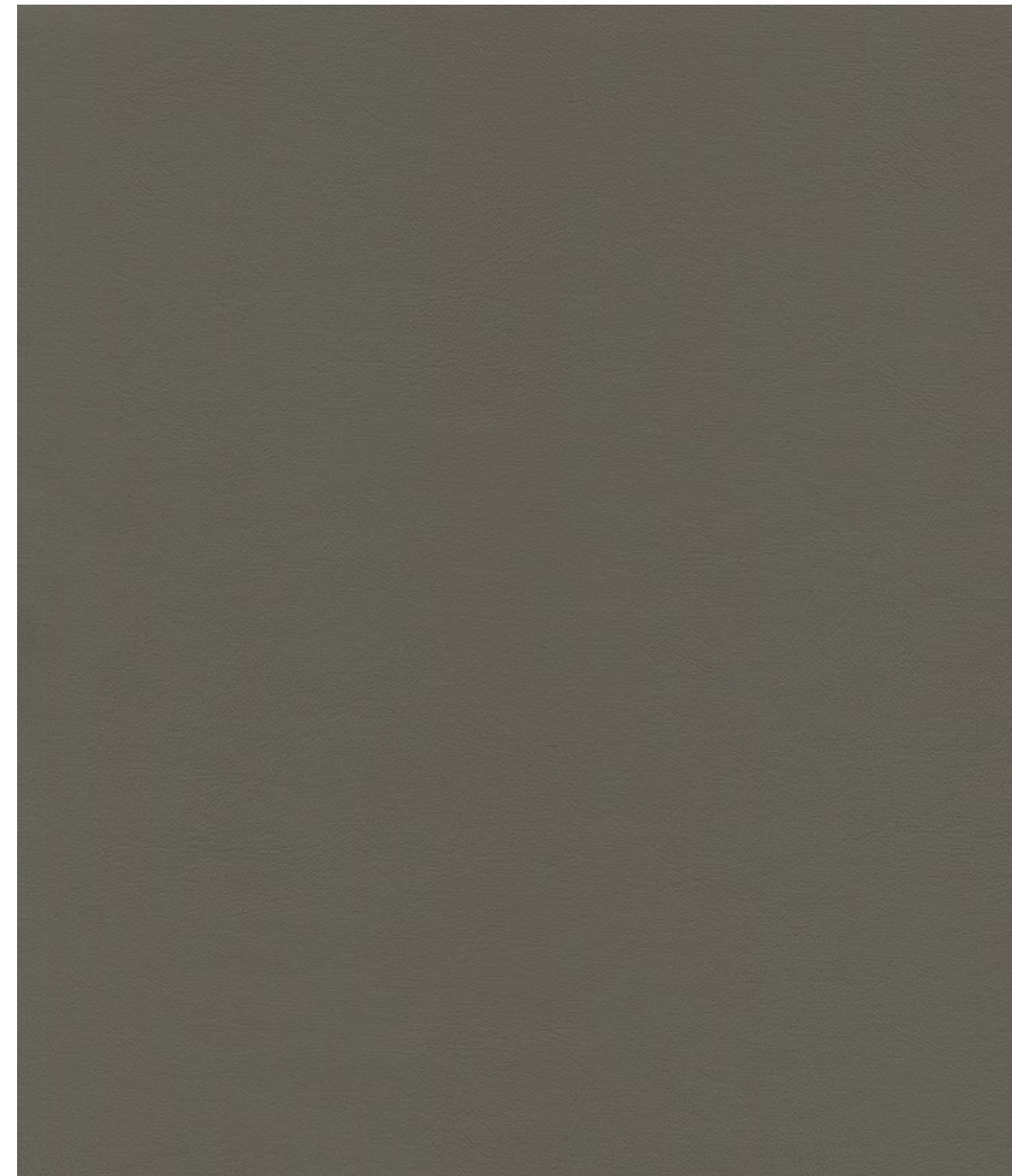

skai® Pureto EN slate F7610008

**skai® Pureto EN**

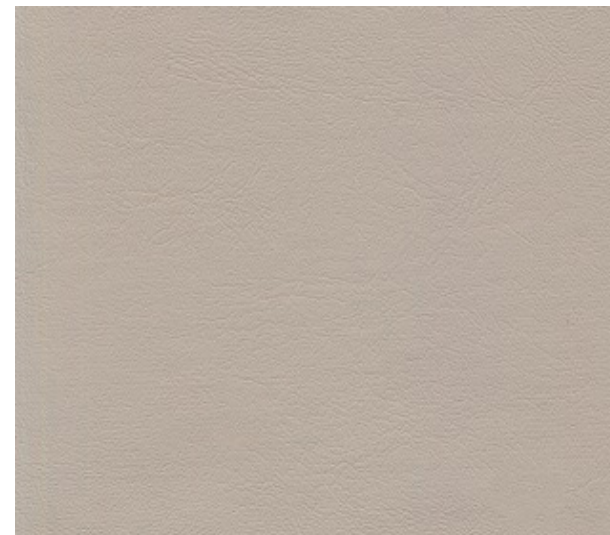

silkgrey F7610009



birch F7610010

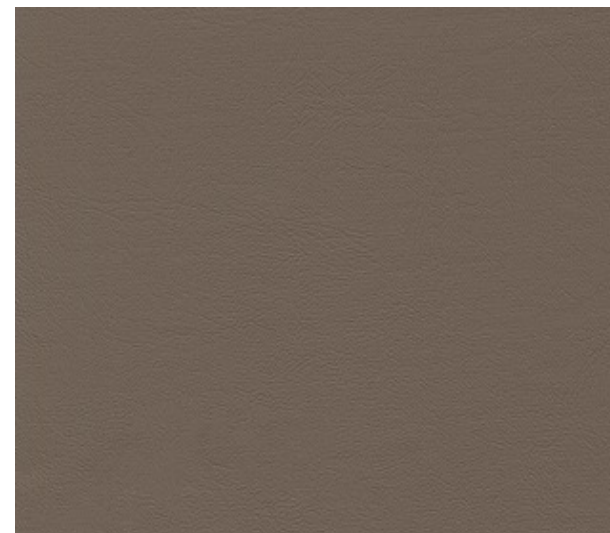

taupe F7610011

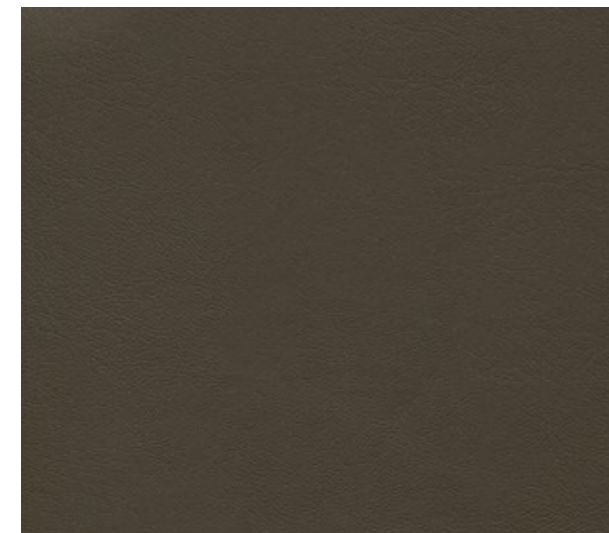

mocca F7610012

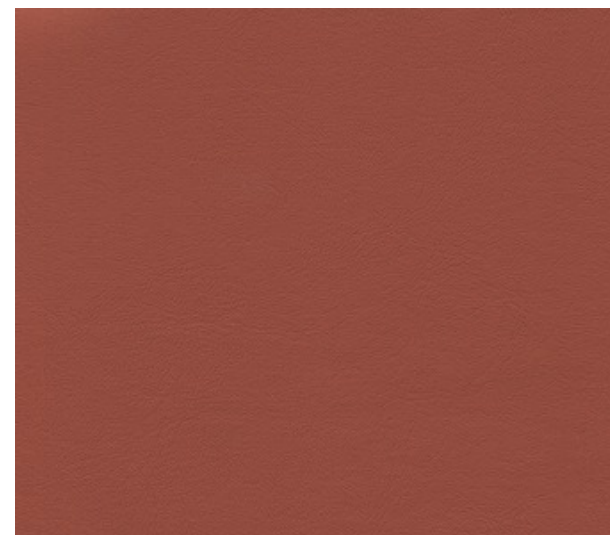

marsala F7610013

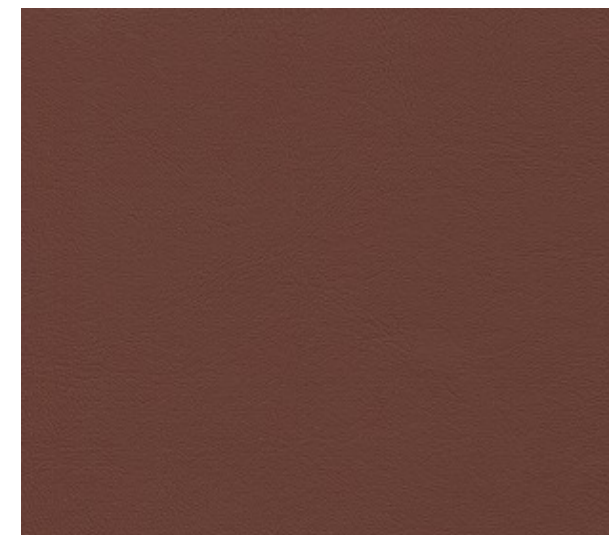

merlot F7610014

**skai® Pureto EN**

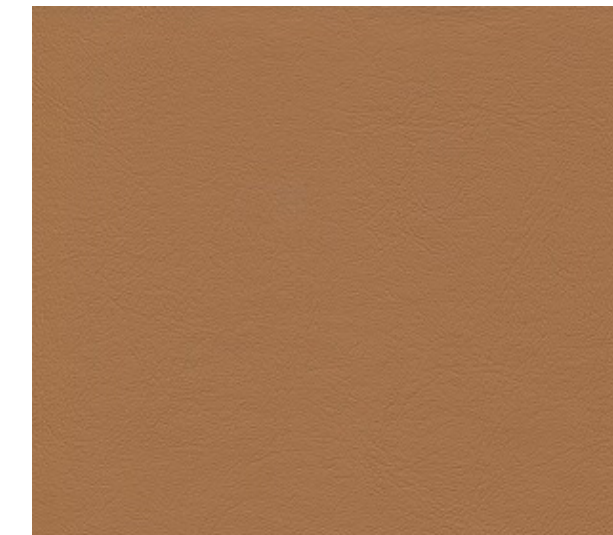

gobi F7610015

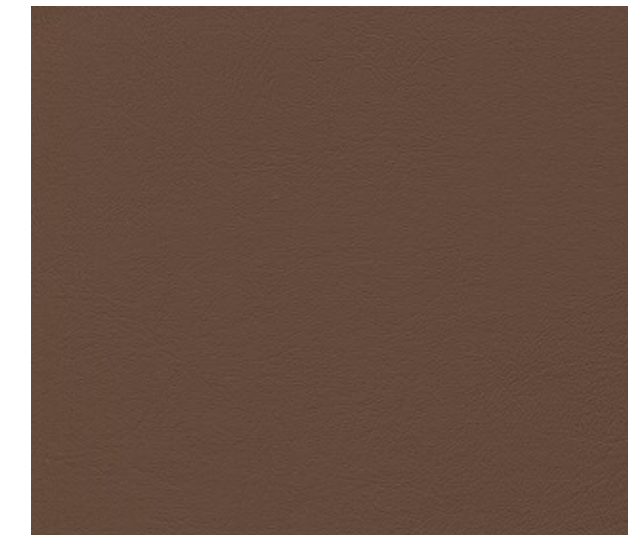

humus F7610016

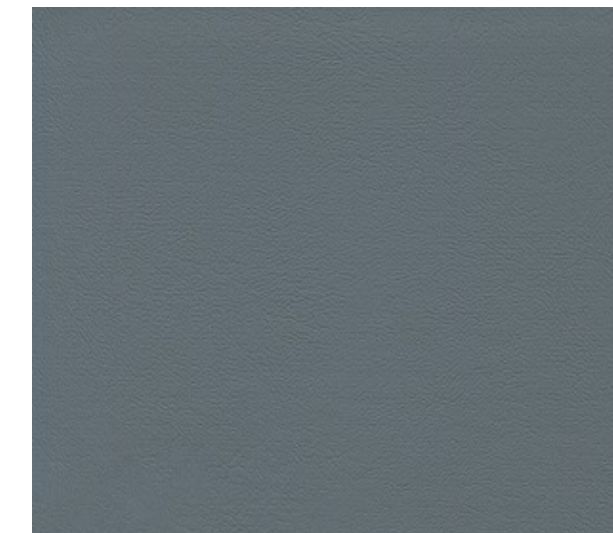

stone blue F7610017



deep sea F7610018

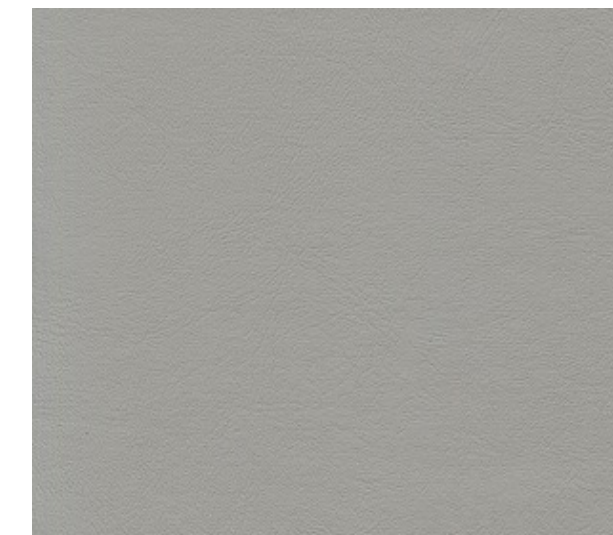

concrete F7610019

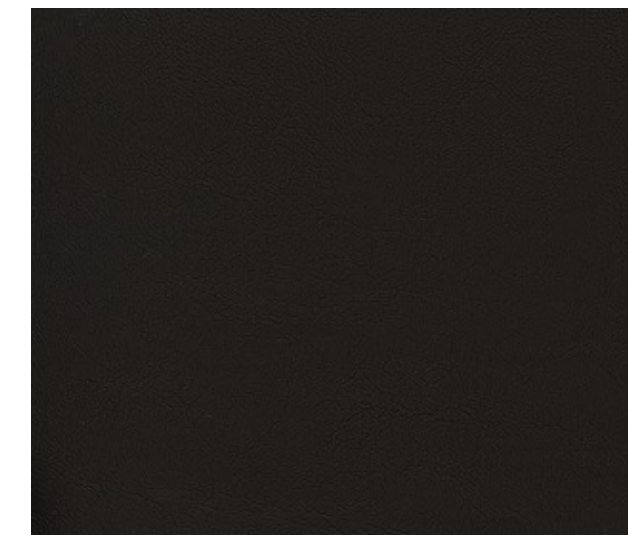

black F7610020



Public Area



Hospitality



Residential

**Materialzusammensetzung:**

ca. 60 % PU-Compound  
ca. 40 % BW/PES-Gestrick  
**Gewicht:** 640 +/- 50 g/m<sup>2</sup>  
**Dicke:** 1,1 +/- 0,2 mm  
**Rollenbreite:** 140 cm  
**Rollenlänge:** 30 m

**Material composition:**

approx. 60 % PU-compound  
approx. 40 % CO/PES-knitted fabric  
**weight:** 640 +/- 50 g/m<sup>2</sup>  
28.9 +/- 2.3 oz/yd  
**Thickness:** 1.1 +/- 0.2 mm  
**Roll width:** 140 cm / 55.1 in  
**Roll length:** 30 m / 32.8 yd

**Composición del material:**

aprox. 60 % compuesto de PU  
aprox. 40 % soporte textil de punto de algodón/PES  
**Peso:** 640 +/- 50 g/m<sup>2</sup>  
**Espesor:** 1,1 +/- 0,2 mm  
**Ancho de rollo:** 140 cm  
**Largo de rollo:** 30 m



langlebig  
long-lasting  
larga vida útil



lichtecht  
lightfast  
resistente a la luz  
DIN EN ISO 105-B02,  
Stufe 6 / level 6



abriebfest  
abrasion resistant  
resistencia a la abrasión  
DIN EN ISO 5470-2:  
≥ 100 000 Martindale  
invers/inverse/inverso  
ASTM D4157 / CFFA-1A:  
≥ 100 000  
Abrieb Wyzenbeek  
double rubs Wyzenbeek  
doble frota Wyzenbeek



schwer entflammbar  
flame protection  
resistencia al fuego  
EN 1021-1-2, BS 5852 IS-O+1,  
MVSS 302, CA TB 117-2013,  
UFAC/NFPA 260 Class 1



pflegeleicht  
easy to clean  
fácil mantenimiento



reißfest  
tear resistant  
resistente al desgarro



0161/2023  
IMO FTPC 2010 Part 8



hydrolysebeständig  
hydrolysis resistant  
resistente a hidrólisis  
21d / 70°C



phthalatfrei  
phthalate-free  
no contiene ftalatos



erfüllt Spielzeugnorm  
fulfills toys norm  
Cumple la norma para  
juguetes  
DIN EN 71-3



lösungsmittelfrei  
solvent free  
exento de solvente



vegan  
vegan  
vegano



nachhaltig  
sustainable  
sostenible

**Anwendung / Verarbeitung**

Geeignet für viele Arten von Bepolsterungen und Bespannungen in der Polsterindustrie. Besonders geeignet für den Einsatz im trendorientierten Wohn- und Objektbereich, in öffentlichen Gebäuden und Einrichtungen. Problemlose Verarbeitung nach den üblichen Verfahren (Nähen, Heften, Kleben, Nageln). Keine eingefärbten Kleber oder Lösemittelkleber verwenden!

**Sonstige Hinweise**

Zum Erhalt der Materialeigenschaften Ihres skai® Produktes ist eine regelmäßige Reinigung der Materialoberfläche erforderlich. Benutzen Sie hierzu eine warme, milde Seifenlauge und ein Mikrofasertuch oder eine weiche Handbürste. Bitte verwenden Sie keine chemischen Bleichen oder scheuernde Reinigungsmittel. Bitte beachten Sie, dass Anfärbungen des Materials durch Jeans oder andere Textilien von jeglicher Gewährleistung ausgenommen sind.

**Besondere Hinweise**

Unsere anwendungstechnischen Empfehlungen in Wort und Schrift, die wir aufgrund unserer Erfahrung entsprechend dem aktuellen Stand der Technik weitergeben, sind unverbindlich. Sie entbinden den Käufer nicht davon, die Eignung unsere Produkte für den vorgesehenen Verwendungszweck in eigener Verantwortung selbst zu prüfen. Dies gilt insbesondere für alle Komponenten, die zusammen mit unserem Produkt verarbeitet werden und deren Verträglichkeit im Verbund. Im Übrigen gelten unsere allgemeinen Geschäftsbedingungen. Hiermit verlieren alle früheren, anderslautenden Regelungen ihre Gültigkeit.

**Application / Processing**

Suitable for many kinds of upholsteries and coverings in the upholstery industry. Especially suitable for the use in the modern residential and contract area, in public buildings and institutions. Problem-free processing in the usual procedures (sewing, tacking, sticking, nailing). Do not use colored adhesives or solvent adhesives!

**Other instructions**

To maintain the material properties of your skai® product, it is necessary to regularly clean the material surface. Use a warm, mild soap solution and a microfiber cloth or a soft hand brush for this purpose. Please do not use chemical bleach or abrasive cleaning agents. Please note that staining of the material through jeans or other textiles is excluded from any warranty.

**Special notes**

Our spoken and written application engineering recommendations, which we pass on based on our experience and in accordance with the current state of the art, are non-binding. They do not absolve buyers of their own responsibility to check the suitability of our products for the intended purpose. This applies in particular to all components that are processed together with our product and their compatibility in combination with each other. Otherwise, our general terms and conditions are in effect. All earlier provisions to the contrary hereby become invalid.

**Aplicaciones / Manipulación**

Apto para múltiples tipos de tapizado y revestimientos para la industria del mueble tapizado. Especialmente diseñado para el empleo en espacios modernos tanto públicos como privados, en edificios públicos e instituciones. Aplicación sencilla por medio de procedimientos habituales (cosido, hilvanado, pegado, clavado). ¡No utilizar adhesivos tintados ni a base de disolventes!

**Otros consejos**

Para conservar las propiedades del material de su producto de skai® es necesario limpiar regularmente la superficie del material. Utilice para ello lejía jabonosa suave y tibia con un paño de microfibra o un cepillo de mano suave. No utilice blanqueadores químicos ni productos de limpieza abrasivos. Tenga en cuenta que las manchas por decoloración en el material causadas por pantalones vaqueros u otros tejidos quedan excluidas de cualquier garantía.

**Advertencias especiales**

Las recomendaciones de aplicaciones técnicas que ofrecemos, ya sea de palabra o por escrito, en base a nuestra experiencia y conforme a los avances tecnológicos actuales, no son vinculantes. En ningún caso eximirán al comprador de comprobar por sí mismo y bajo su propia responsabilidad la idoneidad de nuestros productos para la finalidad de uso prevista. Esto se aplica especialmente para todos aquellos componentes que se utilicen junto con nuestro producto y su compatibilidad al combinarlos. En todo lo demás, se aplicarán nuestras condiciones generales, lo que supone la nulidad de cualquier otro acuerdo previo.



\*nach den gesetzlichen Bestimmungen prescribed by law de conformidad con las disposiciones legales





skai® VyP Nappa:



skai® VyP Lana:



red dot winner 2021

# skai® VyP Nappa, skai® VyP Lana Innovation



with laif technology



# VyP Nappa, skai® VyP Lana



Das leistungsstarke Polstermaterial mit detailgetreuer Lederoptik und breiter Farbrange setzt neue Maßstäbe in Komfort und Nachhaltigkeit. Dank der laif Technologie ist das Hybridmaterial aus Vinyl und PU atmungsaktiv und ideal für alle Anwendungen, bei denen langes Sitzen die Regel ist.

The high-performance upholstery material with a realistic leather look and wide color range sets new standards in comfort and sustainability. Thanks to laif technology, the hybrid material of vinyl and PU is breathable and ideal for all applications where sitting for long periods is the rule.

El material de tapicería de alto rendimiento, con un aspecto de cuero totalmente natural y una amplia gama de colores, establece nuevos estándares de confort y sostenibilidad. Mediante la tecnología laif, se consigue que el material híbrido de vinilo y PU sea transpirable e ideal para todas las aplicaciones en las que es habitual estar sentado de forma prolongada en el tiempo.



skai® VyP Nappa ashgrey F7901011



skai® VyP Lana nude F7901033

## skai® VyP Nappa



pearl F7901002



fango F7901004



moss F7901008

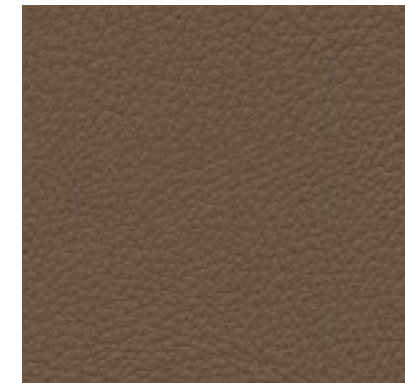

smoke F7901005

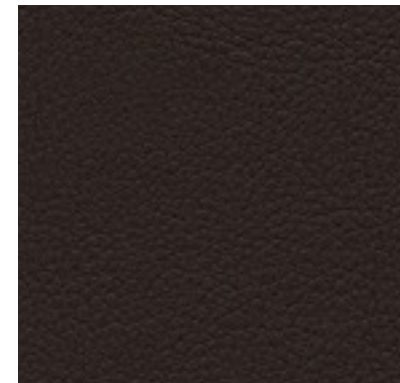

choco F7901006



carmine F7901009



navy blue F7901010

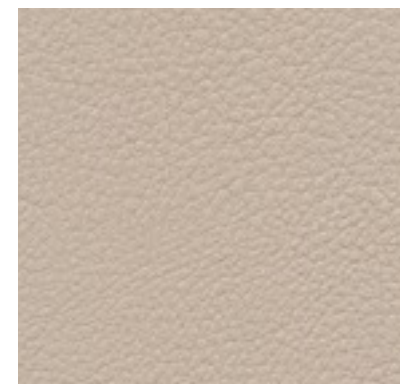

ashgrey F7901011



anthracite F7901013

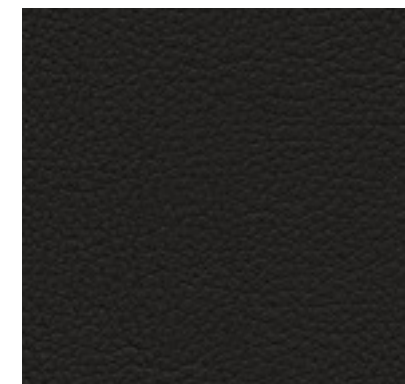

black F7901014

## skai® VyP Lana



creme F7901032



nude F7901033



lightblue F7901034

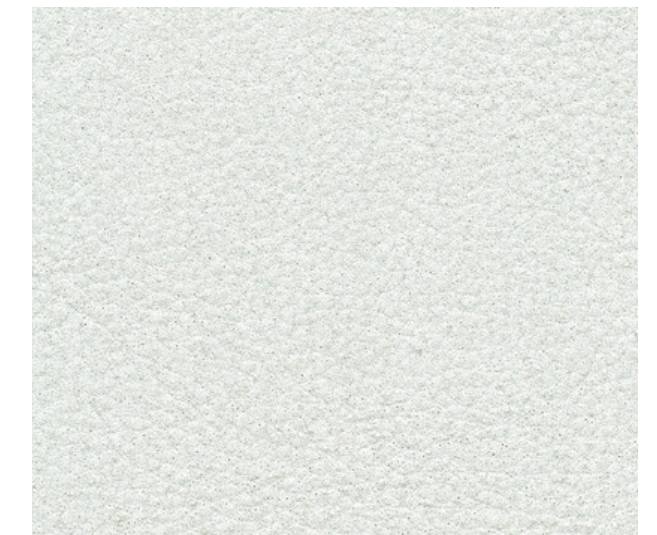

ashgrey F7901030



stonebeige F7901031



pistazio F7901035





Public Area



Hospitality



Residential

**Materialzusammensetzung:**

ca. 63 % Vinyl/PU-Compound  
ca. 37 % BW/PES-Gestrick  
**Gewicht:** 720 +/- 50 g/m<sup>2</sup>  
**Dicke:** 1,4 +/- 0,2 mm  
**Rollenbreite:** 140 cm  
**Rollenlänge:** 30 m

**Material composition:**

approx. 63 % Vinyl/PU-compound  
approx. 37 % CO/PES-knitted fabric  
**Weight:** 720 +/- 50 g/m<sup>2</sup>  
32.5 +/- 2.3 oz/yd  
**Thickness:** 1.4 +/- 0.2 mm  
**Roll width:** 140 cm / 55.1 in  
**Roll length:** 30 m / 32.8 yd

**Composición del material:**

aprox. 63 % compuesto de Vinilo/PU  
aprox. 37 % soporte textil de punto de algodón/PES  
**Peso:** 720 +/- 50 g/m<sup>2</sup>  
**Espesor:** 1,4 +/- 0,2 mm  
**Ancho de rollo:** 140 cm  
**Largo de rollo:** 30 m



atmungsaktiv  
breathable  
transpirable



reißfest  
tear resistant  
resistente al desgarro



pflegeleicht  
easy to clean  
fácil mantenimiento



abriebfest  
abrasion resistant  
resistencia a la abrasión  
**DIN EN ISO 5470-2:**  
≥ 100 000 Martindale  
**invers/inverso**  
**ASTM D4157 / CFFA-1A:**  
≥ 100 000  
**skai® VyP Nappa:**  
**Abrieb Wyzenbeek**  
**double rubs Wyzenbeek**  
**doble frota Wyzenbeek**



langlebig  
long-lasting  
larga vida útil



lichtecht  
lightfast  
resistente a la luz  
**DIN EN ISO 105-B02,**  
**Stufe 6 / level 6 / nivel 6**



dehnfähig  
extensible  
extensible



phthalatfrei  
phthalate-free  
no contiene ftalatos



vegan  
vegan  
vegano



nachhaltig  
sustainable  
sostenible



schwer entflammbar  
flame protection  
resistencia al fuego  
**DIN EN 1021-1+2,**  
**BS 5852 IS-O+1, MVSS**  
**302, IMO FTPC P8,**  
**CA TB 117-2013, UFAC/**  
**NFPA260 Class 1,**  
**compliant with CAL**  
**AB 2998**



lösungsmittelfrei  
solvent free  
exento de solvente

**Anwendung / Verarbeitung**

Geeignet für viele Arten von Bepolsterungen und Spannungen in der Polsterindustrie. Besonders geeignet für den Einsatz im trendorientierten Wohn- und Objektbereich, in öffentlichen Gebäuden und Einrichtungen. Problemlose Verarbeitung nach den üblichen Verfahren (Nähen, Heften, Kleben, Nageln). Keine eingefärbten Kleber oder Lösemittelkleber verwenden!

**Sonstige Hinweise**

Zum Erhalt der Materialeigenschaften Ihres skai® Produktes ist eine regelmäßige Reinigung der Materialoberfläche erforderlich. Benutzen Sie hierzu eine warme, milde Seifenlauge und ein Mikrofasertuch oder eine weiche Handbürste. Bitte verwenden Sie keine chemischen Bleichen oder scheuernde Reinigungsmittel. Bitte beachten Sie, dass Anfärbungen des Materials durch Jeans oder andere Textilien von jeglicher Gewährleistung ausgenommen sind.

**Besondere Hinweise**

Unsere anwendungstechnischen Empfehlungen in Wort und Schrift, die wir aufgrund unserer Erfahrung entsprechend dem aktuellen Stand der Technik weitergeben, sind unverbindlich. Sie entbinden den Käufer nicht davon, die Eignung unsere Produkte für den vorgesehenen Verwendungszweck in eigener Verantwortung selbst zu prüfen. Dies gilt insbesondere für alle Komponenten, die zusammen mit unserem Produkt verarbeitet werden und deren Verträglichkeit im Verbund. Im Übrigen gelten unsere allgemeinen Geschäftsbedingungen. Hiermit verlieren alle früheren, anderslautenden Regelungen ihre Gültigkeit.

**Application / Processing**

Suitable for many kinds of upholsterys and coverings in the upholstery industry. Especially suitable for the use in the modern residential and contract area, in public buildings and institutions. Problem-free processing in the usual procedures (sewing, tacking, sticking, nailing). Do not use colored adhesives or solvent adhesives!

**Other instructions**

To maintain the material properties of your skai® product, it is necessary to regularly clean the material surface. Use a warm, mild soap solution and a microfiber cloth or a soft hand brush for this purpose. Please do not use chemical bleach or abrasive cleaning agents. Please note that staining of the material through jeans or other textiles is excluded from any warranty.

**Special notes**

Our spoken and written application engineering recommendations, which we pass on based on our experience and in accordance with the current state of the art, are non-binding. They do not absolve buyers of their own responsibility to check the suitability of our products for the intended purpose. This applies in particular to all components that are processed together with our product and their compatibility in combination with each other. Otherwise, our general terms and conditions are in effect. All earlier provisions to the contrary hereby become invalid.

**Aplicaciones / Manipulación**

Apto para múltiples tipos de tapizado y revestimientos para la industria del mueble tapizado. Especialmente diseñado para el empleo en espacios modernos tanto públicos como privados, en edificios públicos e instituciones. Aplicación sencilla por medio de procedimientos habituales (cosido, hilvanado, pegado, clavado). ¡No utilizar adhesivos tintados ni a base de disolventes!

**Otros consejos**

Para conservar las propiedades del material de su producto de skai® es necesario limpiar regularmente la superficie del material. Utilice para ello lejía jabonosa suave y tibia con un paño de microfibra o un cepillo de mano suave. No utilice blanqueadores químicos ni productos de limpieza abrasivos. Tenga en cuenta que las manchas por decoloración en el material causadas por pantalones vaqueros u otros tejidos quedan excluidas de cualquier garantía.

**Advertencias especiales**

Las recomendaciones de aplicaciones técnicas que ofrecemos, ya sea de palabra o por escrito, en base a nuestra experiencia y conforme a los avances tecnológicos actuales, no son vinculantes. En ningún caso eximirán al comprador de comprobar por sí mismo y bajo su propia responsabilidad la idoneidad de nuestros productos para la finalidad de uso prevista. Esto se aplica especialmente para todos aquellos componentes que se utilicen junto con nuestro producto y su compatibilidad al combinarlos. En todo lo demás, se aplicarán nuestras condiciones generales, lo que supone la nulidad de cualquier otro acuerdo previo.



\* nach den gesetzlichen Bestimmungen prescribed by law de conformidad con las disposiciones legales





## Spitzenleistung / High Performance / Rendimiento insuperable

Wasserdampf- und Luftdurchlässigkeit / Water vapor permeability and air permeability / Permeabilidad al vapor de agua y el aire

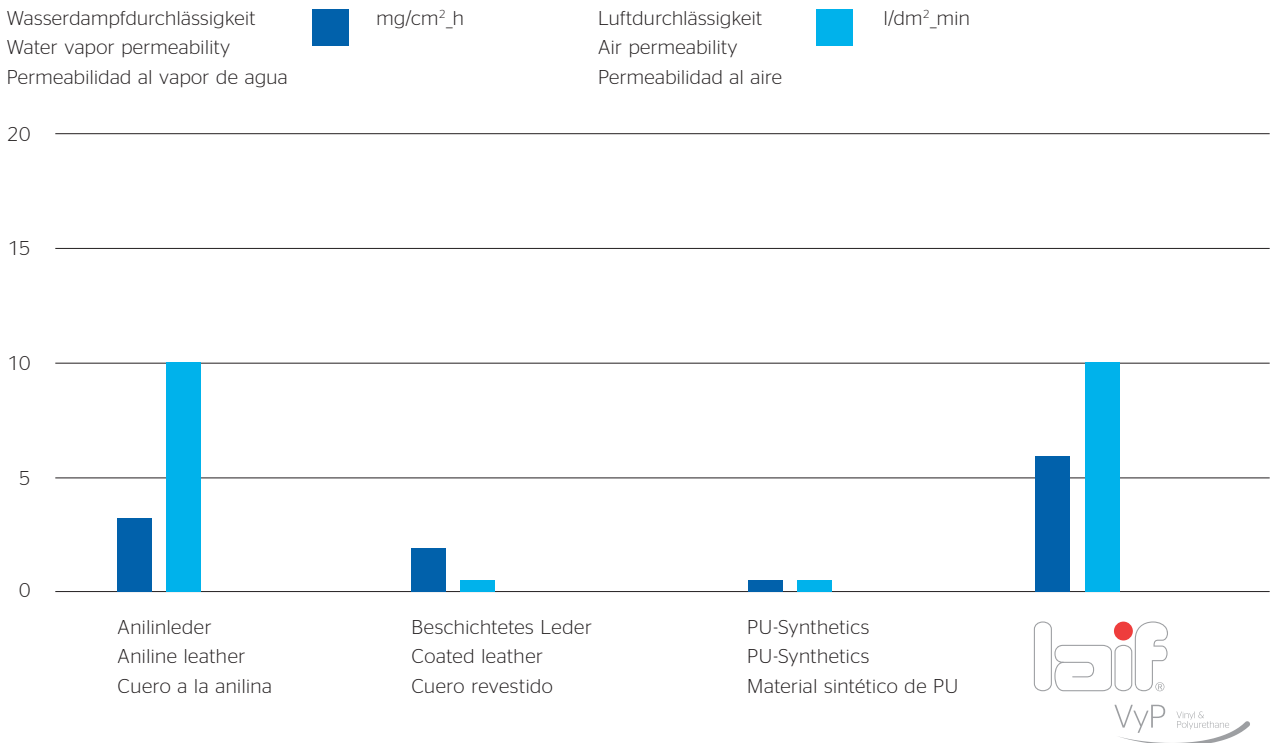

## Funktionsprinzip / Function Principle / Principio funcional

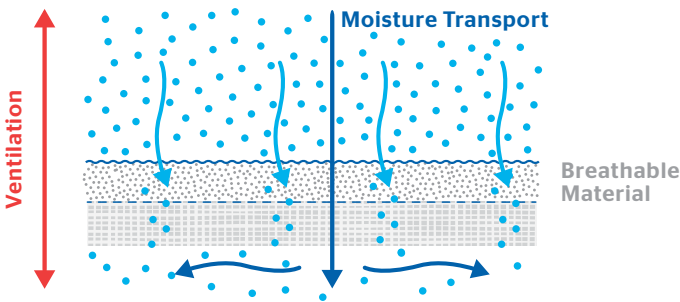

### Herausragende Eigenschaften

- > Niedrige Emissionen
- > Phthalatfrei
- > Gute Hydrolysebeständigkeit
- > Lösemittelfreie PU-Komponente
- > Dispersionsbasierte Finishierung
- > Gute Abriebbeständigkeit
- > Schwer entflammbar

### Highlights

- > Low emissions
- > Phthalate-free
- > Good hydrolysis resistance
- > Solvent-free PU component
- > Dispersion-based finished
- > Good abrasion resistance
- > Flame-retardant

### Características excepcionales

- > Bajas emisiones
- > Sin ftalatos
- > Buena resistencia a la hidrólisis
- > Componentes de PU sin disolventes
- > Acabado basado en la dispersión
- > Buena resistencia a la abrasión
- > Difícilmente inflamable



**Continental**   
The Future in Motion

**skai<sup>®</sup> Mano S**  
Innovation



# Mano S



Hochwertiges skai® Material mit feingliedriger Kalbsledernarbung. Die Oberfläche des Materials ist elektrisch leitfähig und deshalb besonders für Anwendungsbereiche geeignet, in denen eine elektrostatische Aufladung vermieden werden soll.

High-quality skai® material with fine calf leather grain. The surface of the material is electrically conductive and therefore particularly well suitable for application areas in which electrostatic charges must be avoided.

Un material skai® de alta calidad con un delicado grano de cuero vacuno. La superficie del material es conductora de electricidad y, por tanto, especialmente idónea para ámbitos de aplicación en los que se desea evitar las cargas electrostáticas.

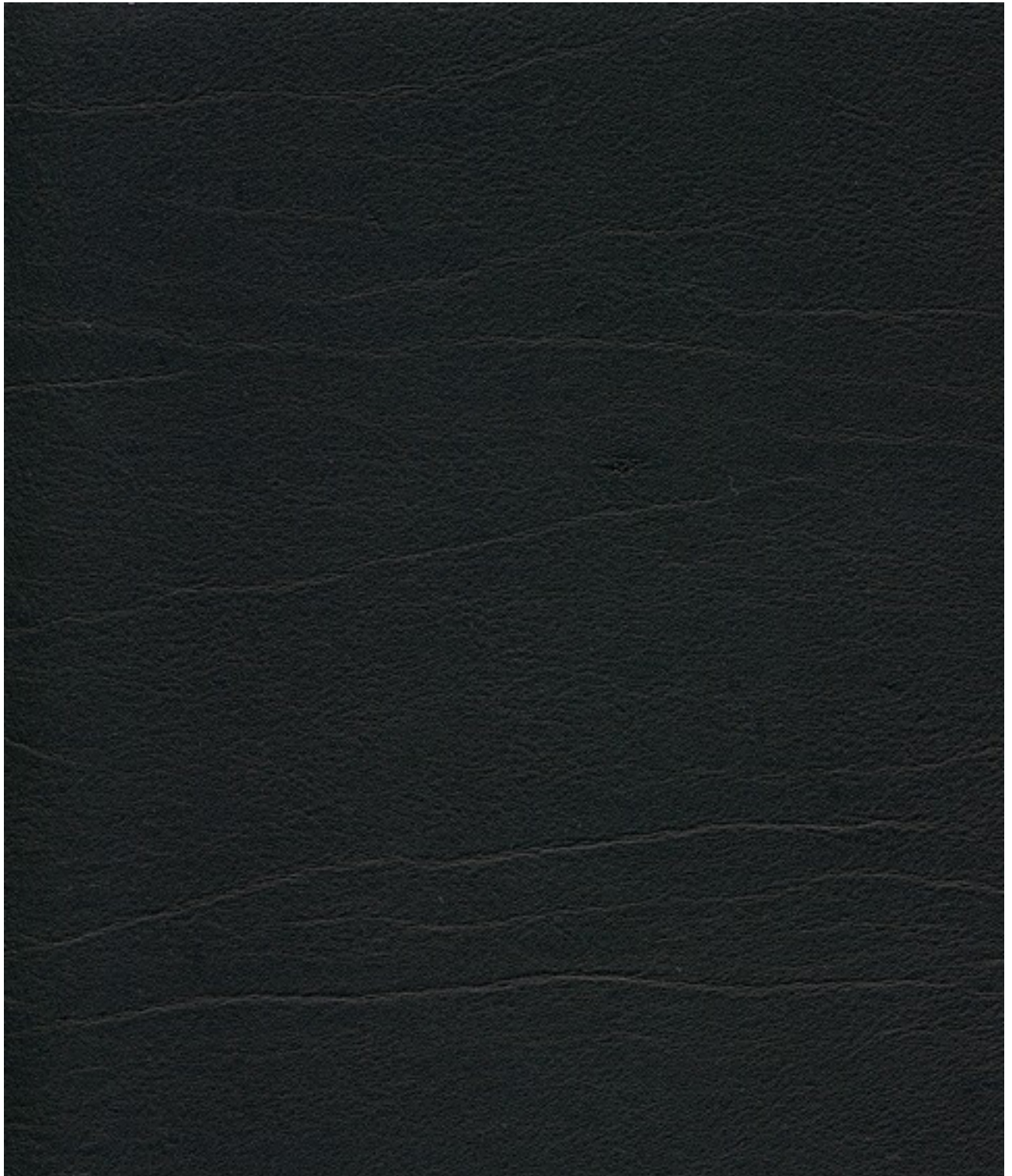

**skai® Mano S** schwarz F6461486



**Materialzusammensetzung:**

ca. 90 % PVC-Compound  
 ca. 10 % BW/PES-Gestrick  
**Gewicht:** 650 +/- 50 g/m<sup>2</sup>  
**Dicke:** 1,1 +/- 0,2mm  
**Rollenbreite:** 137 cm  
**Rollenlänge:** 30 m

**Material composition:**

approx. 90 % PVC-compound  
 approx. 10 % CO/PES-knitted fabric  
**Weight:** 650 +/- 50 g/m<sup>2</sup>  
**Thickness:** 1.1 +/- 0.2 mm  
**Roll width:** 137 cm  
**Roll length:** 30 m

**Composición del material:**

aprox. 90 % compuesto de PVC  
 aprox. 10 % soporte textil de punto de algodón/PES  
**Peso:** 650 +/- 50 g/m<sup>2</sup>  
**Espesor:** 1,1 +/- 0,2 mm  
**Ancho de rollo:** 137 cm  
**Largo de rollo:** 30 m



**langelig**  
 long-lasting  
 larga vida útil



**reißfest**  
 tear resistant  
 resistente al desgarro



**pflegeleicht**  
 easy to clean  
 fácil mantenimiento



**lichtecht**  
 lightfast  
 resistente a la luz



**elektrisch leitfähig**  
 electrically conductive  
 conductor eléctrico



**vegan**  
 vegan  
 vegano

**Anwendung / Verarbeitung**

Geeignet für Bereiche, die gegen elektrostatische Aufladung geschützt werden müssen. Problemlose Verarbeitung nach den üblichen Verfahren (Nähen, Heften, Kleben, Nageln). Keine eingefärbten Kleber oder Lösemittelkleber verwenden!

**Sonstige Hinweise**

Zum Erhalt der Materialeigenschaften Ihres skai® Produktes ist eine regelmäßige Reinigung der Materialoberfläche erforderlich. Benutzen Sie hierzu den skai® Reiniger oder eine warme, milde Seifenlauge und ein Mikrofasertuch. Bitte verwenden Sie keine chemischen Bleichen oder scheuernde Reinigungsmittel. Bitte beachten Sie, dass Anfärbungen des Materials durch Jeans oder andere Textilien von jeglicher Gewährleistung ausgenommen sind.

**Besondere Hinweise**

Unsere anwendungstechnischen Empfehlungen in Wort und Schrift, die wir aufgrund unserer Erfahrung entsprechend dem aktuellen Stand der Technik weitergeben, sind unverbindlich. Sie entbinden den Käufer nicht davon, die Eignung unsere Produkte für den vorgesehenen Verwendungszweck in eigener Verantwortung selbst zu prüfen. Dies gilt insbesondere für alle Komponenten, die zusammen mit unserem Produkt verarbeitet werden und deren Verträglichkeit im Verbund. Im Übrigen gelten unsere allgemeinen Geschäftsbedingungen. Hiermit verlieren alle früheren, anderslautenden Regelungen ihre Gültigkeit.

**Application / Processing**

Suitable for areas that must be protected against electrostatic charging. Problem-free processing in the usual procedures (sewing, tacking, sticking, nailing). Do not use colored adhesives or solvent adhesives!

**Other instructions**

To maintain the material properties of your skai® product, it is necessary to regularly clean the material surface. For cleaning, please use skai® cleaning agent or a warm, mild soapy water and a microfiber cloth. Please do not use chemical bleach or abrasive cleaning agents. Please note that staining of the material through jeans or other textiles is excluded from any warranty.

**Special notes**

Our spoken and written application engineering recommendations, which we pass on based on our experience and in accordance with the current state of the art, are non-binding. They do not absolve buyers of their own responsibility to check the suitability of our products for the intended purpose. This applies in particular to all components that are processed together with our product and their compatibility in combination with each other. Otherwise, our general terms and conditions are in effect. All earlier provisions to the contrary hereby become invalid.

**Aplicaciones / Manipulación**

Adecuado para ámbitos que requieren protección contra las cargas estáticas. Aplicación sencilla por medio de procedimientos habituales (cosido, hilvanado, pegado, clavado). ¡No utilizar adhesivos tintados ni a base de disolventes!

**Otros consejos**

Para conservar las propiedades del material de su producto de skai® es necesario limpiar regularmente la superficie del material. Para ello, utilice skai® limpiador o agua jabonosa caliente y suave y un paño de microfibra. No utilice blanqueadores químicos ni productos de limpieza abrasivos. Tenga en cuenta que las manchas por decoloración en el material causadas por pantalones vaqueros u otros tejidos quedan excluidas de cualquier garantía.

**Advertencias especiales**

Las recomendaciones de aplicaciones técnicas que ofrecemos, ya sea de palabra o por escrito, en base a nuestra experiencia y conforme a los avances tecnológicos actuales, no son vinculantes. En ningún caso eximirán al comprador de comprobar por sí mismo y bajo su propia responsabilidad la idoneidad de nuestros productos para la finalidad de uso prevista. Esto se aplica especialmente para todos aquellos componentes que se utilicen junto con nuestro producto y su compatibilidad al combinarlos. En todo lo demás, se aplicarán nuestras condiciones generales, lo que supone la nulidad de cualquier otro acuerdo previo.



\* nach den gesetzlichen Bestimmungen prescribed by law de conformidad con las disposiciones legales



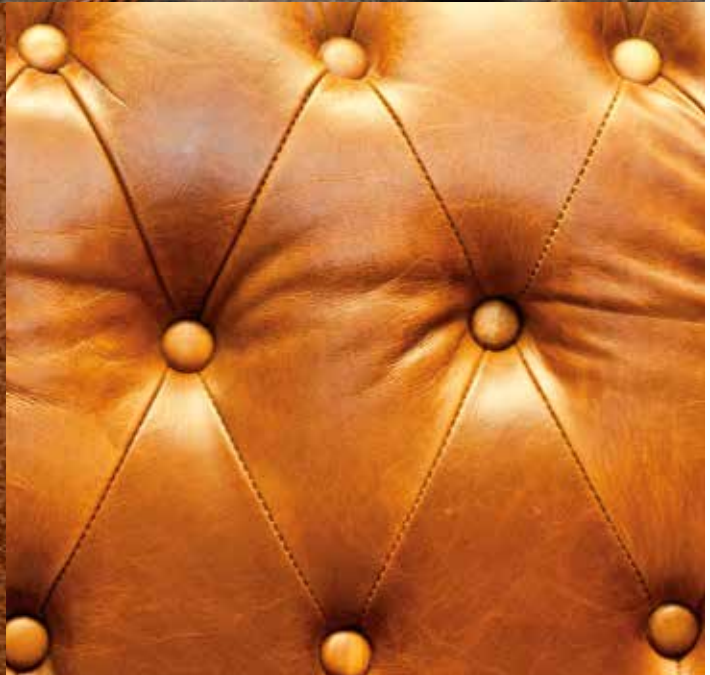

## Leather Design EN

**Continental**   
The Future in Motion

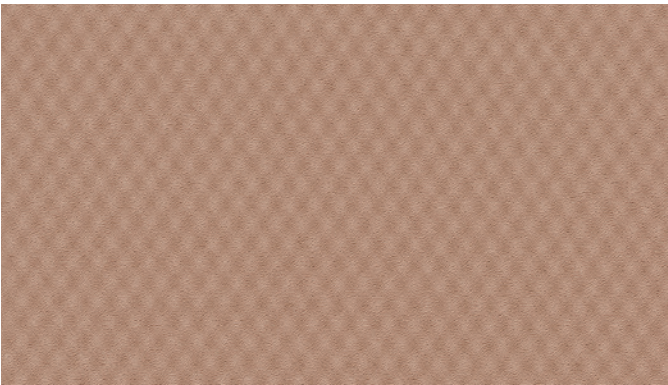
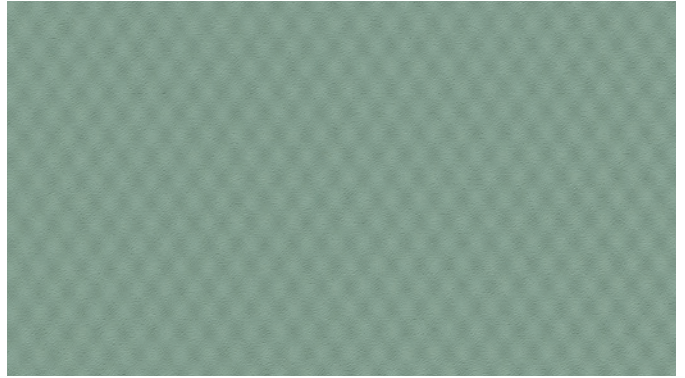

**skai® Tovosoft EN**  
Leather Design EN



Alles im Fluss - der voluminöse Softtouch-Effekt des Kunstleders skai® Tovosoft EN wird durch eine faszinierende Wabenstruktur erzielt, die zum Anfassen einlädt und Ruhe ausstrahlt. Die weiche Haptik harmonisiert dabei perfekt mit der soften Farbpalette, die den Fokus auf Nude-, Beige- und Erdtöne legt.

Everything in flow - the voluminous softtouch effect of the skai® Tovosoft EN synthetic leather is achieved through a fascinating honeycomb structure that invites the touch and radiates calm. Its soft feel harmonizes perfectly with the soft color range, which focuses on nude, beige and earth tones.

Todo fluye: el voluminoso efecto de flujo de la piel sintética skai® Tovosoft EN se consigue mediante una fascinante estructura de panal que invita a tocarla e irradia tranquilidad. El tacto suave armoniza perfectamente con la gama de colores suaves centrada en los tonos Nude, Beige y Tierra.

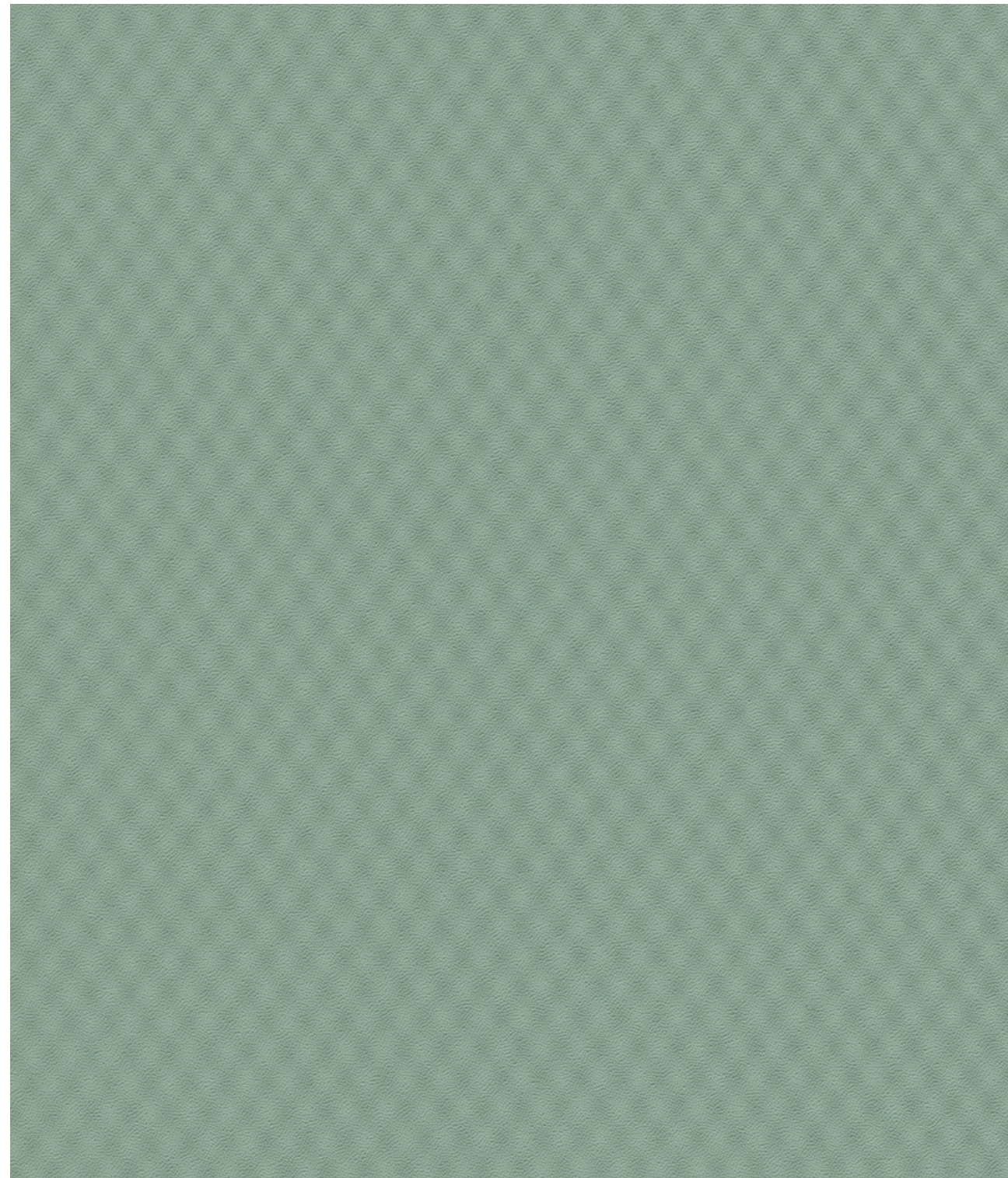

skai® Tovosoft EN sage F6470138

**skai® Tovosoft EN**

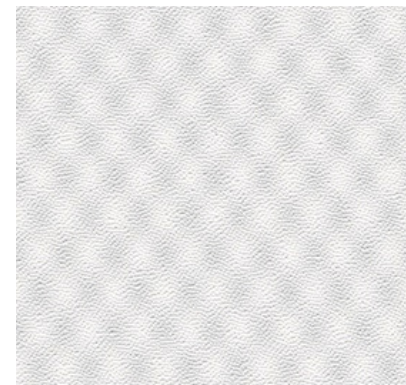

coconut milk F6470132



birch F6470131

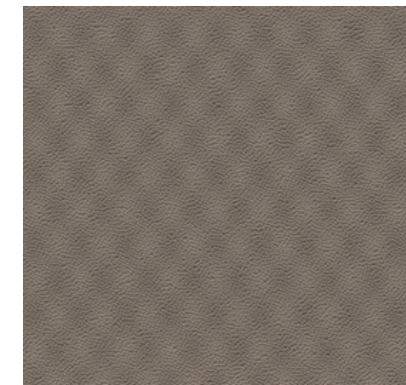

cinder F6470133

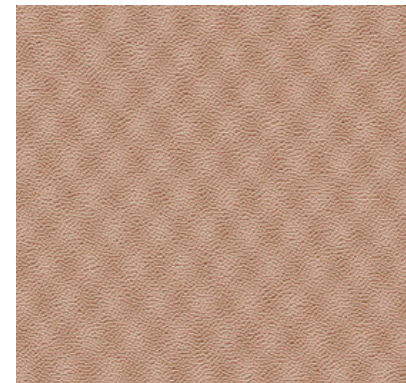

rose tan F6470135

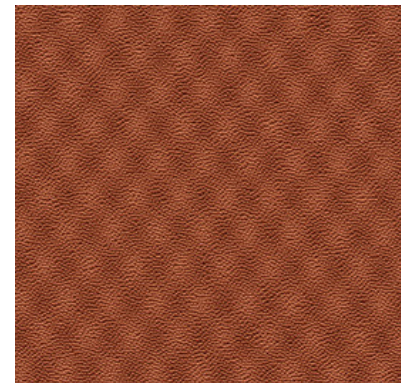

terra F6470144

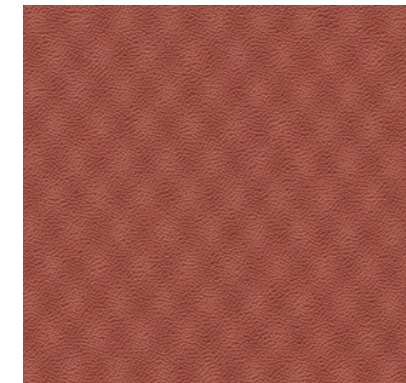

marsala F6470136

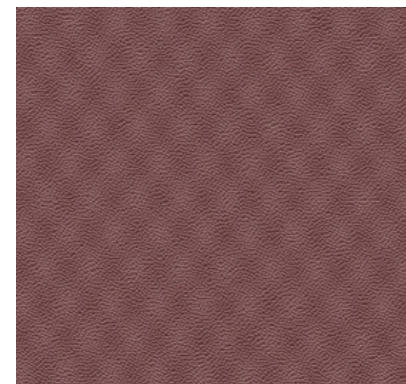

merlot F6470137

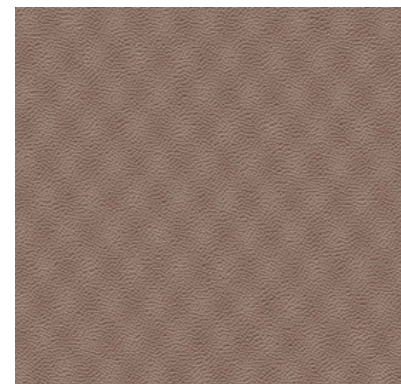

cocoa F6470134

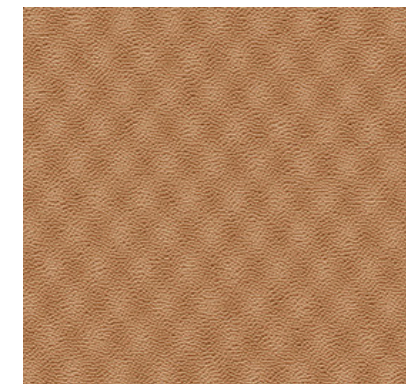

gobi F6470145



reed F6470140



dark moss F6470139

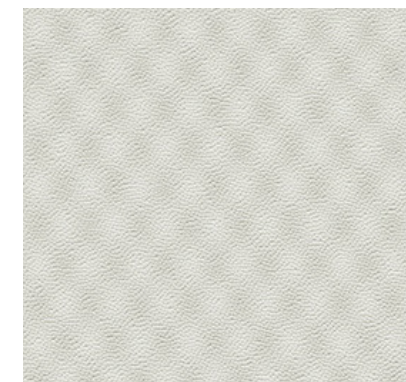

calm grey F6470141

**skai® Tovosoft EN**

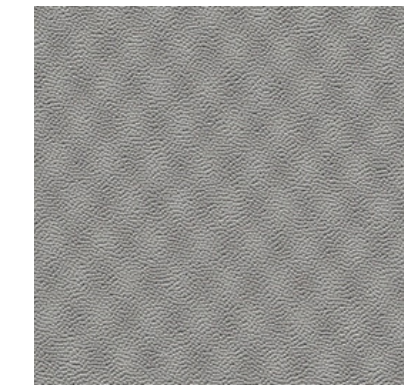

stormy grey F6470142

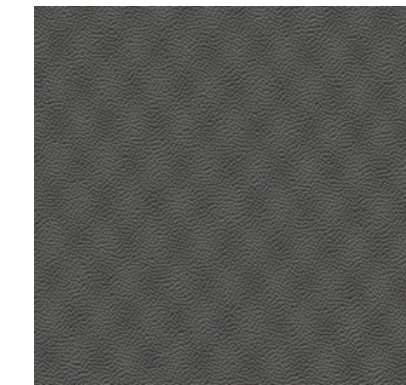

anthracite F6470143

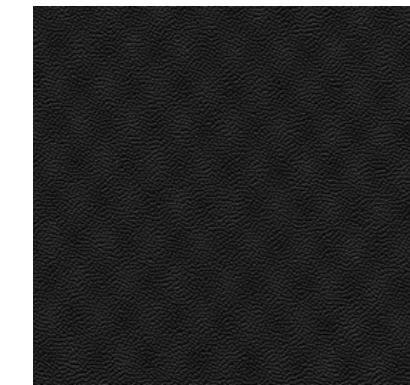

black F6470146



Public Area



Hospitality



Residential



Healthcare



Fitness

**Materialzusammensetzung:**

ca. 84% PVC-Compound  
ca. 16% Recycling PES-Gestrick  
**Gewicht:** 740 +/- 50 g/m<sup>2</sup>  
**Dicke:** 1,1 +/- 0,2 mm  
**Rollenbreite:** 140 cm  
**Rollenlänge:** 30m

**Material composition:**

approx. 84% PVC-compound  
approx. 16% recycling PES-knitted fabric  
**Weight:** 740 +/- 50 g/m<sup>2</sup>  
**Thickness:** 1.1 +/- 0.2 mm  
**Roll width:** 140cm  
**Roll length:** 30m

**Composición del material:**

aprox. 84% compuesto de PVC  
aprox. 16% reciclaje soporte textil de punto de PES  
**Peso:** 740 +/- 50 g/m<sup>2</sup>  
**Espesor:** 1,1 +/- 0,2 mm  
**Ancho de rollo:** 140cm  
**Largo de rollo:** 30m



langlebig  
long-lasting  
larga vida útil



reißfest  
tear resistant  
resistente al desgarro



abriebfest  
abrasion resistant  
resistencia a la abrasión  
**DIN EN ISO 5470-2:**  
≥ 150 000 Martindale  
invers/inverse/inverso



schwer entflammbar  
flame protection  
resistencia al fuego  
**DIN EN 1021-1+2,**  
**BS 5852 IS-O+1, MVSS302,**  
**compliant with CAL AB**  
**2998, IMO FTPC P8**



pflegeleicht  
easy to clean  
fácil mantenimiento



lichtecht  
lightfast  
resistencia a la luz  
**DIN EN ISO 105-BS02,**  
**Stufe 6, level 6, nivel 6**



blut- und urinbeständig  
blood- and urine resistant  
resistente a la sangre  
y a la orina



weich und dehnfähig  
soft and stretchable  
Suave y elástico



phthalatfrei  
phthalate-free  
no contiene ftalatos



Träger aus recycelter PES Faser  
Recycled PES fibre backing  
Soporte de fibra PES reciclada



vegan  
vegan  
vegano

**Anwendung / Verarbeitung**

Geeignet für viele Arten von Bepolsterungen und Spannungen in der Polsterindustrie. Besonders geeignet für den Einsatz im trendorientierten Wohn- und Objektbereich, in öffentlichen Gebäuden und Einrichtungen. Problemlose Verarbeitung nach den üblichen Verfahren (Nähen, Heften, Kleben, Nageln). Keine eingefärbten Kleber oder Lösemittelkleber verwenden!

**Sonstige Hinweise**

Zum Erhalt der Materialeigenschaften Ihres skai® Produktes ist eine regelmäßige Reinigung der Materialoberfläche erforderlich. Benutzen Sie hierzu den skai® Reiniger oder eine warme, milde Seifenlauge und ein Mikrofasertuch. Bitte verwenden Sie keine chemischen Bleichen oder scheuernde Reinigungsmittel. Bitte beachten Sie, dass Anfärbungen des Materials durch Jeans oder andere Textilien von jeglicher Gewährleistung ausgenommen sind.

**Besondere Hinweise**

Unsere anwendungstechnischen Empfehlungen in Wort und Schrift, die wir aufgrund unserer Erfahrung entsprechend dem aktuellen Stand der Technik weitergeben, sind unverbindlich. Sie entbinden den Käufer nicht davon, die Eignung unsere Produkte für den vorgesehenen Verwendungszweck in eigener Verantwortung selbst zu prüfen. Dies gilt insbesondere für alle Komponenten, die zusammen mit unserem Produkt verarbeitet werden und deren Verträglichkeit im Verbund. Im Übrigen gelten unsere allgemeinen Geschäftsbedingungen. Hiermit verlieren alle früheren, anderslautenden Regelungen ihre Gültigkeit.

**Application / Processing**

Suitable for many kinds of upholsteries and coverings in the upholstery industry. Especially suitable for the use in the modern residential and contract area, in public buildings and institutions. Problem-free processing in the usual procedures (sewing, tacking, sticking, nailing). Do not use colored adhesives or solvent adhesives!

**Other instructions**

To maintain the material properties of your skai® product, it is necessary to regularly clean the material surface. For cleaning, please use skai® cleaning agent or a warm, mild soapy water and a microfiber cloth. Please do not use chemical bleach or abrasive cleaning agents. Please note that staining of the material through jeans or other textiles is excluded from any warranty.

**Special notes**

Our spoken and written application engineering recommendations, which we pass on based on our experience and in accordance with the current state of the art, are non-binding. They do not absolve buyers of their own responsibility to check the suitability of our products for the intended purpose. This applies in particular to all components that are processed together with our product and their compatibility in combination with each other. Otherwise, our general terms and conditions are in effect. All earlier provisions to the contrary hereby become invalid.

**Aplicaciones / Manipulación**

Adecuado para numerosos tipos de tapizados y revestimientos en el sector de la tapicería. Especialmente adecuado para su uso en el ámbito residencial exclusivo y de tendencia y en instalaciones y edificios públicos. Aplicación sencilla por medio de procedimientos habituales (cosido, hilvanado, pegado, clavado). ¡No utilizar adhesivos tintados ni a base de disolventes!

**Otros consejos**

Para conservar las propiedades del material de su producto de skai® es necesario limpiar regularmente la superficie del material. Para ello, utilice skai® limpiador o agua jabonosa caliente y suave y un paño de microfibra. No utilice blanqueadores químicos ni productos de limpieza abrasivos. Tenga en cuenta que las manchas por decoloración en el material causadas por pantalones vaqueros u otros tejidos quedan excluidas de cualquier garantía.

**Advertencias especiales**

Las recomendaciones de aplicaciones técnicas que ofrecemos, ya sea de palabra o por escrito, en base a nuestra experiencia y conforme a los avances tecnológicos actuales, no son vinculantes. En ningún caso eximirán al comprador de comprobar por sí mismo y bajo su propia responsabilidad la idoneidad de nuestros productos para la finalidad de uso prevista. Esto se aplica especialmente para todos aquellos componentes que se utilicen junto con nuestro producto y su compatibilidad al combinarlos. En todo lo demás, se aplicarán nuestras condiciones generales, lo que supone la nulidad de cualquier otro acuerdo previo.



\* nach den gesetzlichen Bestimmungen prescribed by law de conformidad con las disposiciones legales





**skai® Tovel EN**  
Leather Design EN

**New**  
Article  
2021



# Tovel EN



skai® Tovel EN überzeugt in attraktiven Naturtönen mit außergewöhnlich weicher Haptik und samtiger Anmutung überall, wo hohe Anforderungen an Polsteroberflächen gestellt werden. Mit feiner Mikrostruktur und elegantem Wolkendruck bringt die abriebfeste und flammhemmend ausgerüstete Neuheit kompromisslosen Komfort in moderne Interieurs.

skai® Tovel EN impresses with its exceptionally soft feel and velvety look in attractive natural tones wherever heavy demands are made on upholstery surfaces. With its fine microstructure and elegant cloud print, this abrasion-resistant and flame-retardant innovation brings solid comfort to modern interiors.

skai® Tovel EN seduce por sus atractivas tonalidades naturales y su tacto excepcionalmente suave, que proporciona una impresión aterciopelada adecuada para superficies tapizadas con grandes exigencias. Con su fina microestructura y un elegante estampado de nubes, este novedoso producto resistente a la abrasión e ignífugo aporta un confort sin concesiones a los interiores modernos.



skai® Tovel EN cashmere F6470151

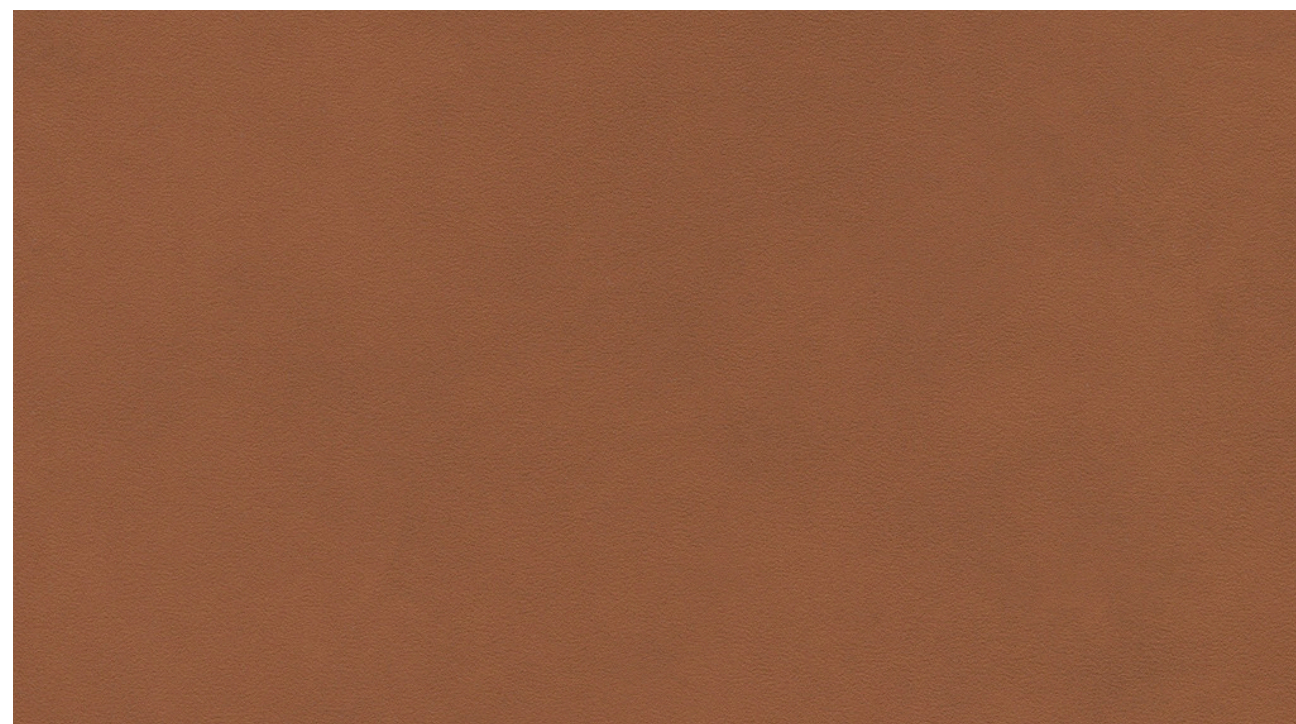

skai® Tovel EN terra F6470159

# skai® Tovel EN

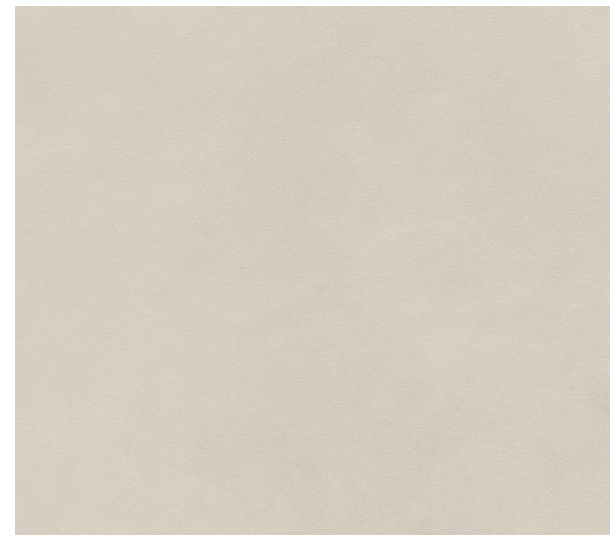

lightbeige F6470150



birch F6470152

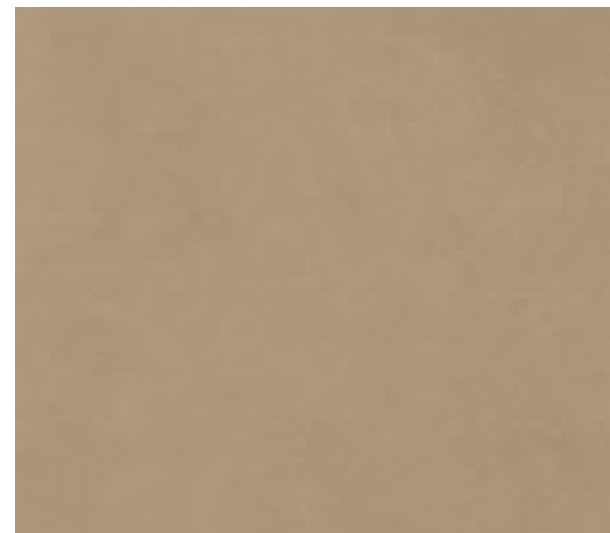

sand F6470156

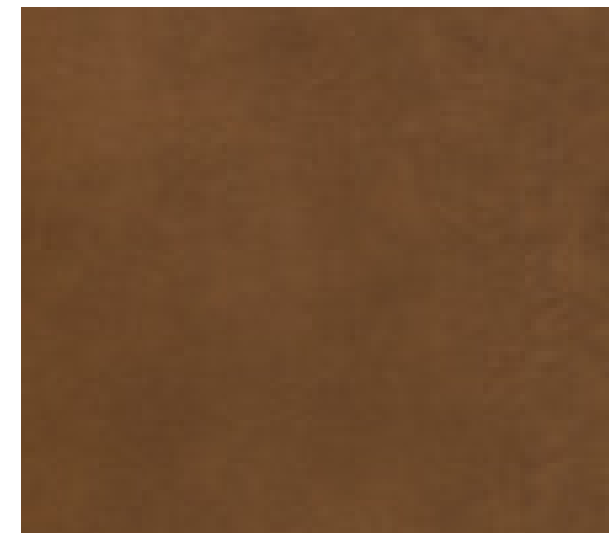

nut F6470158

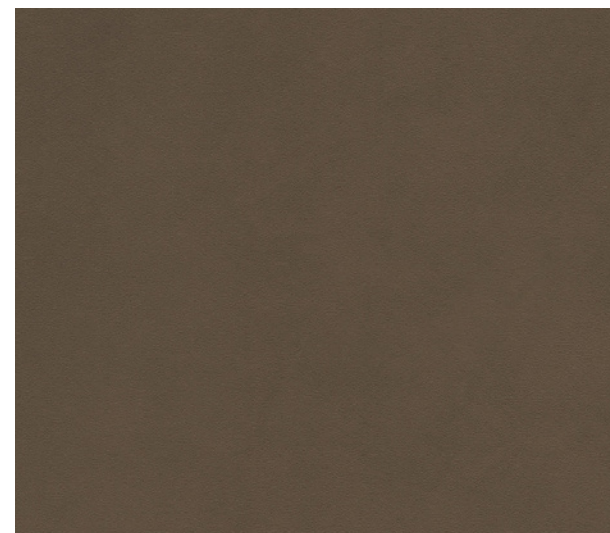

fango F6470157

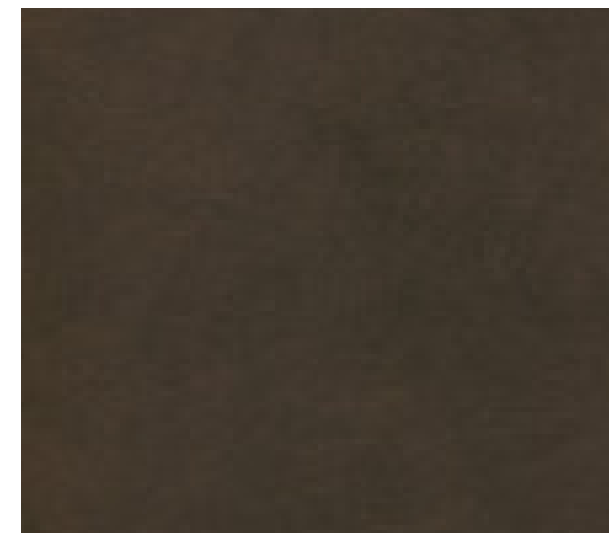

choco F6470160

# skai® Tovel EN

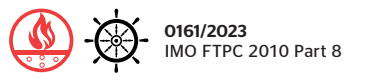

ashgrey F6470153

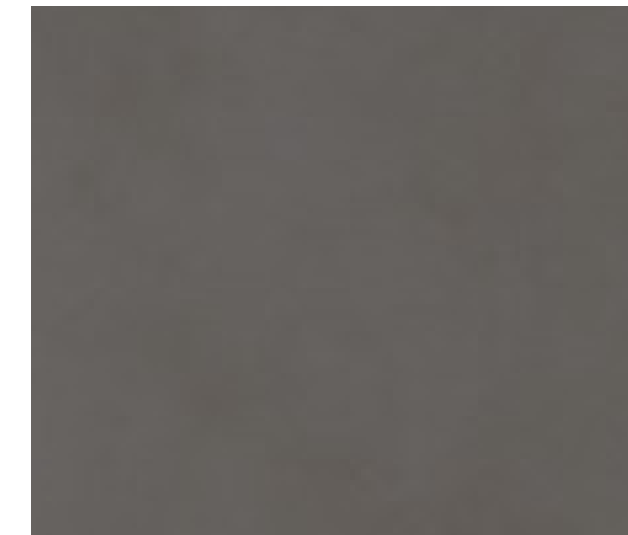

slate grey F6470161

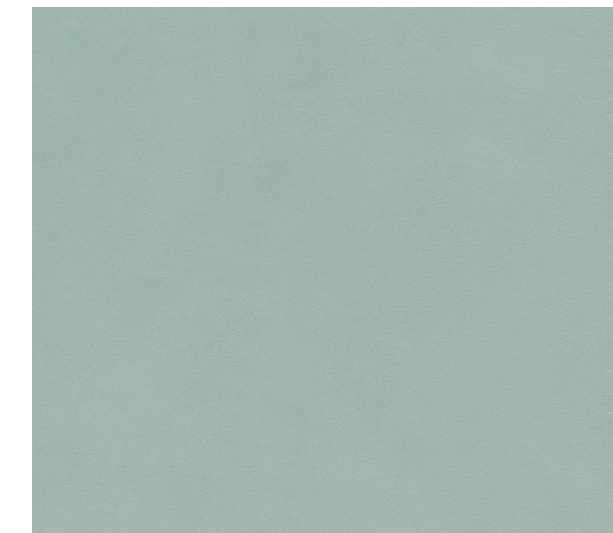

sage F6470154

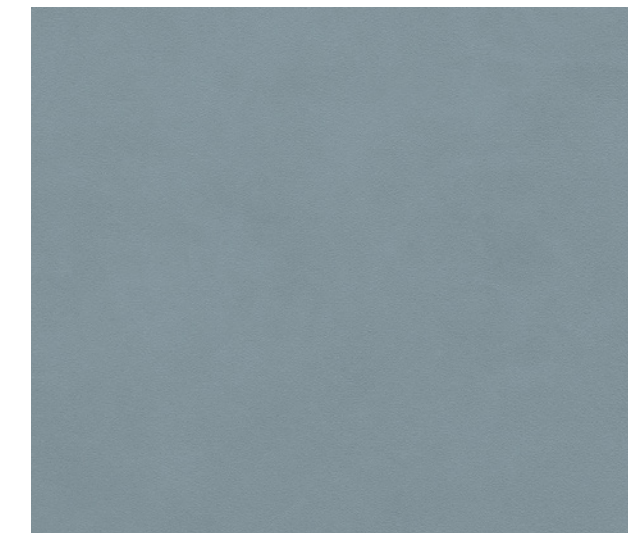

lightblue F6470155

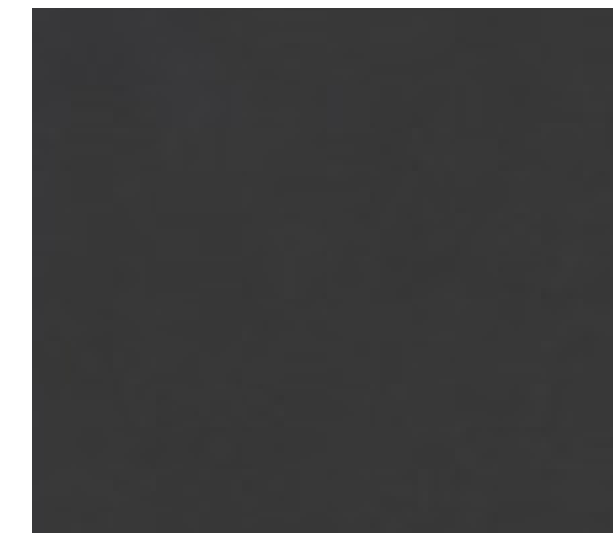

anthracite F6470162

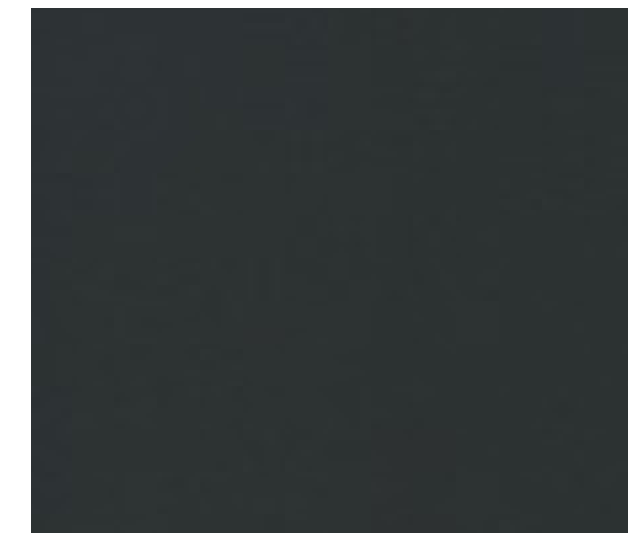

black F6470163



Public Area



Hospitality



Residential



Healthcare



Fitness

**Materialzusammensetzung:**

ca. 84% PVC-Compound  
ca. 16% PES-Gestrick  
**Gewicht:** 740 +/- 50 g/m<sup>2</sup>  
**Dicke:** 1,3 +/- 0,2 mm  
**Rollenbreite:** 140 cm  
**Rollenlänge:** 30m

**Material composition:**

approx. 84% PVC-compound  
approx. 16% PES-knitted fabric  
**Weight:** 740 +/- 50 g/m<sup>2</sup>  
**Thickness:** 1.3 +/- 0.2 mm  
**Roll width:** 140cm  
**Roll length:** 30m

**Composición del material:**

aprox. 84% compuesto de PVC  
aprox. 16% soporte textil de punto de PES  
**Peso:** 740 +/- 50 g/m<sup>2</sup>  
**Espesor:** 1,3 +/- 0,2 mm  
**Ancho de rollo:** 140cm  
**Largo de rollo:** 30m



langlebig  
long-lasting  
larga vida útil



reißfest  
tear resistant  
resistente al desgarro



abriebfest  
abrasion resistant  
resistencia a la abrasión  
**DIN EN ISO 5470-2:**  
≥ 150 000 Martindale  
invers/inverse/inverso



schwer entflammbar  
flame protection  
resistencia al fuego  
**DIN EN 1021-1+2,**  
**BS 5852 IS-O+1, MVSS302,**  
**IMO FTPC P8, CA TB 117-2013,**  
**UFAC/NFPA260 Class 1,**  
**compliant with CAL AB 2998**



pflegeleicht  
easy to clean  
fácil mantenimiento



lichtecht  
lightfast  
resistencia a la luz  
**DIN EN ISO 105-BS02,**  
**Stufe 6, level 6, nivel 6**



weich und dehnfähig  
soft and stretchable  
Suave y elástico



**0161/2023**  
**IMO FTPC 2010 Part 8**



phthalatfrei  
phthalate-free  
no contiene ftalatos



lösungsmittelfrei  
solvent free  
exento de solvente



vegan  
vegan  
vegano

**Anwendung / Verarbeitung**

Geeignet für viele Arten von Bepolsterungen und Spannungen in der Polsterindustrie. Besonders geeignet für den Einsatz im trendorientierten Wohn- und Objektbereich, in öffentlichen Gebäuden und Einrichtungen. Problemlose Verarbeitung nach den üblichen Verfahren (Nähen, Heften, Kleben, Nageln). Keine eingefärbten Kleber oder Lösemittelkleber verwenden!

**Sonstige Hinweise**

Zum Erhalt der Materialeigenschaften Ihres skai® Produktes ist eine regelmäßige Reinigung der Materialoberfläche erforderlich. Benutzen Sie hierzu eine warme, milde Seifenlauge und ein Mikrofasertuch oder eine weiche Handbürste. Bitte verwenden Sie keine chemischen Bleichen oder scheuernde Reinigungsmittel. Bitte beachten Sie, dass Anfärbungen des Materials durch Jeans oder andere Textilien von jeglicher Gewährleistung ausgenommen sind.

**Besondere Hinweise**

Unsere anwendungstechnischen Empfehlungen in Wort und Schrift, die wir aufgrund unserer Erfahrung entsprechend dem aktuellen Stand der Technik weitergeben, sind unverbindlich. Sie entbinden den Käufer nicht davon, die Eignung unsere Produkte für den vorgesehenen Verwendungszweck in eigener Verantwortung selbst zu prüfen. Dies gilt insbesondere für alle Komponenten, die zusammen mit unserem Produkt verarbeitet werden und deren Verträglichkeit im Verbund. Im Übrigen gelten unsere allgemeinen Geschäftsbedingungen. Hiermit verlieren alle früheren, anderslautenden Regelungen ihre Gültigkeit.

**Application / Processing**

Suitable for many kinds of upholsteries and coverings in the upholstery industry. Especially suitable for the use in the modern residential and contract area, in public buildings and institutions. Problem-free processing in the usual procedures (sewing, tacking, sticking, nailing). Do not use colored adhesives or solvent adhesives!

**Other instructions**

To maintain the material properties of your skai® product, it is necessary to regularly clean the material surface. Use a warm, mild soap solution and a microfiber cloth or a soft hand brush for this purpose. Please do not use chemical bleach or abrasive cleaning agents. Please note that staining of the material through jeans or other textiles is excluded from any warranty.

**Special notes**

Our spoken and written application engineering recommendations, which we pass on based on our experience and in accordance with the current state of the art, are non-binding. They do not absolve buyers of their own responsibility to check the suitability of our products for the intended purpose. This applies in particular to all components that are processed together with our product and their compatibility in combination with each other. Otherwise, our general terms and conditions are in effect. All earlier provisions to the contrary hereby become invalid.

**Aplicaciones / Manipulación**

Adecuado para numerosos tipos de tapizados y revestimientos en el sector de la tapicería. Especialmente adecuado para su uso en el ámbito residencial exclusivo y de tendencia y en instalaciones y edificios públicos. Aplicación sencilla por medio de procedimientos habituales (cosido, hilvanado, pegado, clavado). ¡No utilizar adhesivos tintados ni a base de disolventes!

**Otros consejos**

Para conservar las propiedades del material de su producto de skai® es necesario limpiar regularmente la superficie del material. Utilice para ello lejía jabonosa suave y tibia con un paño de microfibra o un cepillo de mano suave. No utilice blanqueadores químicos ni productos de limpieza abrasivos. Tenga en cuenta que las manchas por decoloración en el material causadas por pantalones vaqueros u otros tejidos quedan excluidas de cualquier garantía.

**Advertencias especiales**

Las recomendaciones de aplicaciones técnicas que ofrecemos, ya sea de palabra o por escrito, en base a nuestra experiencia y conforme a los avances tecnológicos actuales, no son vinculantes. En ningún caso eximirán al comprador de comprobar por sí mismo y bajo su propia responsabilidad la idoneidad de nuestros productos para la finalidad de uso prevista. Esto se aplica especialmente para todos aquellos componentes que se utilicen junto con nuestro producto y su compatibilidad al combinarlos. En todo lo demás, se aplicarán nuestras condiciones generales, lo que supone la nulidad de cualquier otro acuerdo previo.



\* nach den gesetzlichen Bestimmungen prescribed by law de conformidad con las disposiciones legales





**skai® Toledo EN**  
Leather Design EN

Hochwertiges skai® Polstermaterial für universelle Anwendungen. Seine charakteristische Rindsledernarbung verhilft Möbeln und Wänden zu schlichter Eleganz. Das besonders für den Objekteinsatz geeignete Material besticht außerdem mit inneren Werten: Die Oberfläche ist besonders robust und dennoch komfortabel.

High-quality skai® upholstery material for universal use. Its characteristic cowhide grain lends furniture and walls a sleek elegance. The material, which is particularly suitable for contract use, is also impressive due to its innate values: The surface is particularly robust, yet comfortable.

Un material de tapizado skai® de alta calidad para aplicaciones universales. Su característico grano de cuero vacuno aporta a los muebles y paredes una elegancia discreta. Este material, especialmente idóneo para la decoración, convence también por sus valores intrínsecos: su superficie es especialmente robusta, pero a la vez confortable.



**skai® Toledo EN** lime F6470013

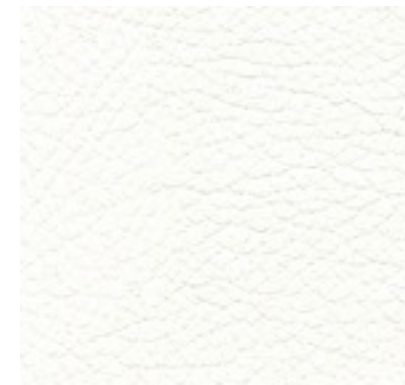

white F6470001

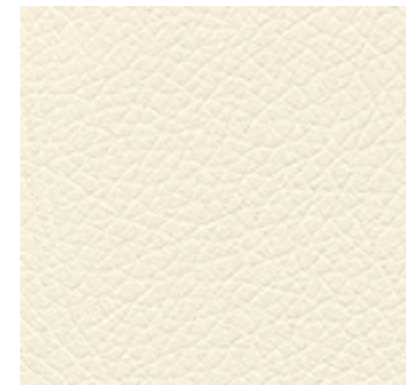

lightbeige F6470002

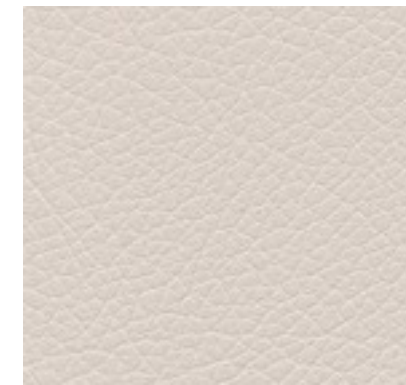

silkgrey F6470003



birch F6470004

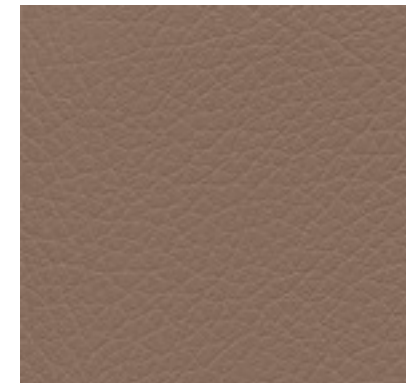

smoke F6470005



fango F6470006

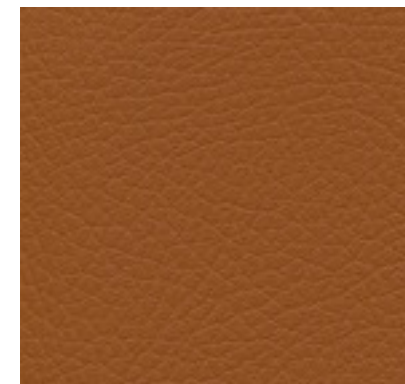

cognac F6470007

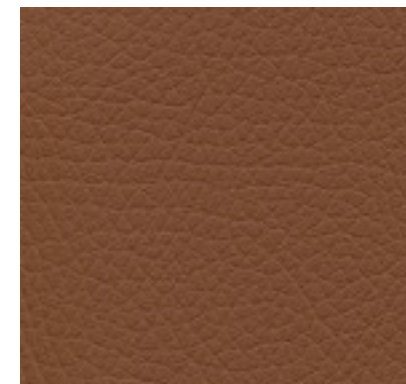

marone F6470008



choco F6470009

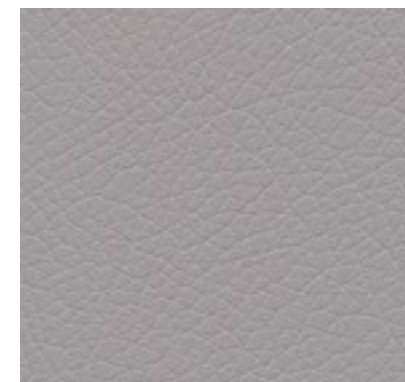

platinum F6470010



anthracite F6470011



black F6470012



sky F6470017



royal F6470018



cherry F6470016

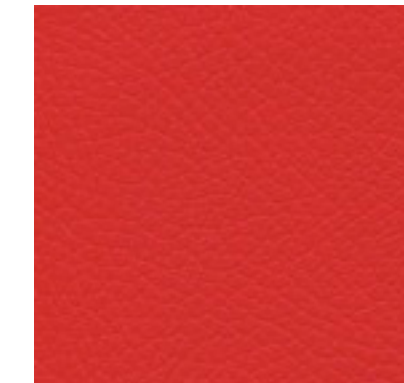

fire F6470015

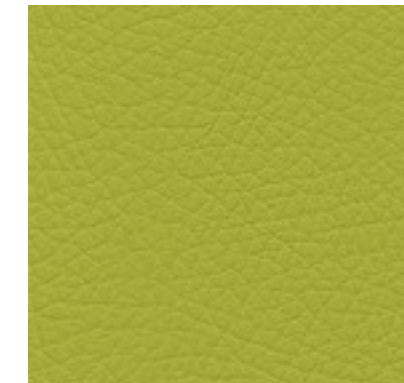

lime F6470013

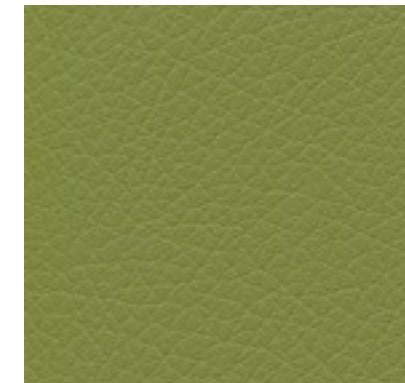

olive F6470014



Public Area



Hospitality



Residential



Healthcare



Fitness

**Materialzusammensetzung:**

ca. 84% PVC-Compound  
ca. 16% PES-Gestrick  
**Gewicht:** 740 +/- 50 g/m<sup>2</sup>  
**Dicke:** 1,4 +/- 0,2 mm  
**Rollenbreite:** 140 cm  
**Rollenlänge:** 30m

**Material composition:**

approx. 84% PVC-compound  
approx. 16% PES-knitted fabric  
**Weight:** 740 +/- 50 g/m<sup>2</sup>  
**Thickness:** 1.4 +/- 0.2 mm  
**Roll width:** 140cm  
**Roll length:** 30m

**Composición del material:**

aprox. 84% compuesto de PVC  
aprox. 16% soporte textil de punto de PES  
**Peso:** 740 +/- 50 g/m<sup>2</sup>  
**Espesor:** 1,4 +/- 0,2 mm  
**Ancho de rollo:** 140cm  
**Largo de rollo:** 30m



langlebig  
long-lasting  
larga vida útil



reißfest  
tear resistant  
resistente al desgarro



abriebfest  
abrasion resistant  
resistencia a la abrasión  
**DIN EN ISO 5470-2:**  
≥ 200 000 Martindale  
invers/inverse/inverso



schwer entflammbar  
flame protection  
resistencia al fuego  
**DIN EN 1021-1+2,**  
**BS 5852 IS-O+1, MVSS302,**  
compliant with CAL AB 2998.



pflegeleicht  
easy to clean  
fácil mantenimiento



lichtecht  
lightfast  
resistencia a la luz  
**DIN EN ISO 105-BS02,**  
**Stufe 6, level 6, nivel 6**



erfüllt DGM RAL GZ 430/4  
fulfills DGM RAL GZ 430/4  
Cumple la norma  
DGM RAL GZ 430/4



**O161/2023**  
IMO FTPC 2010 Part 8



desinfektionsmittelbeständig  
disinfectant resistant  
resistente a los  
desinfectantes



blut- und urinbeständig  
blood- and urine resistant  
resistente a la sangre  
y a la orina



weich und dehnfähig  
soft and stretchable  
Suave y elástico



erfüllt Medizinproduktegesetz  
fulfills medical standard  
cumple la normativa para  
productos sanitarios  
DIN EN ISO 10993-5+10



phthalatfrei  
phthalate-free  
no contiene ftalatos



vegan  
vegan  
vegano

**Anwendung / Verarbeitung**

Geeignet für viele Arten von Bepolsterungen und Spannungen in der Polsterindustrie. Besonders geeignet für den Einsatz im trendorientierten Wohn- und Objektbereich, in öffentlichen Gebäuden und Einrichtungen. Problemlose Verarbeitung nach den üblichen Verfahren (Nähen, Heften, Kleben, Nageln). Keine eingefärbten Kleber oder Lösemittelkleber verwenden!

**Sonstige Hinweise**

Zum Erhalt der Materialeigenschaften Ihres skai® Produktes ist eine regelmäßige Reinigung der Materialoberfläche erforderlich. Benutzen Sie hierzu den skai® Reiniger oder eine warme, milde Seifenlauge und ein Mikrofaser Tuch. Bitte verwenden Sie keine chemischen Bleichen oder scheuernde Reinigungsmittel. Bitte beachten Sie, dass Anfärbungen des Materials durch Jeans oder andere Textilien von jeglicher Gewährleistung ausgenommen sind.

**Besondere Hinweise**

Unsere anwendungstechnischen Empfehlungen in Wort und Schrift, die wir aufgrund unserer Erfahrung entsprechend dem aktuellen Stand der Technik weitergeben, sind unverbindlich. Sie entbinden den Käufer nicht davon, die Eignung unsere Produkte für den vorgesehenen Verwendungszweck in eigener Verantwortung selbst zu prüfen. Dies gilt insbesondere für alle Komponenten, die zusammen mit unserem Produkt verarbeitet werden und deren Verträglichkeit im Verbund. Im Übrigen gelten unsere allgemeinen Geschäftsbedingungen. Hiermit verlieren alle früheren, anderslautenden Regelungen ihre Gültigkeit.

**Application / Processing**

Suitable for many kinds of upholsteries and coverings in the upholstery industry. Especially suitable for the use in the modern residential and contract area, in public buildings and institutions. Problem-free processing in the usual procedures (sewing, tacking, sticking, nailing). Do not use colored adhesives or solvent adhesives!

**Other instructions**

To maintain the material properties of your skai® product, it is necessary to regularly clean the material surface. For cleaning, please use skai® cleaning agent or a warm, mild soapy water and a microfiber cloth. Please do not use chemical bleach or abrasive cleaning agents. Please note that staining of the material through jeans or other textiles is excluded from any warranty.

**Special notes**

Our spoken and written application engineering recommendations, which we pass on based on our experience and in accordance with the current state of the art, are non-binding. They do not absolve buyers of their own responsibility to check the suitability of our products for the intended purpose. This applies in particular to all components that are processed together with our product and their compatibility in combination with each other. Otherwise, our general terms and conditions are in effect. All earlier provisions to the contrary hereby become invalid.

**Aplicaciones / Manipulación**

Adecuado para numerosos tipos de tapizados y revestimientos en el sector de la tapicería. Especialmente adecuado para su uso en el ámbito residencial exclusivo y de tendencia y en instalaciones y edificios públicos. Aplicación sencilla por medio de procedimientos habituales (cosido, hilvanado, pegado, clavado). ¡No utilizar adhesivos tintados ni a base de disolventes!

**Otros consejos**

Para conservar las propiedades del material de su producto de skai® es necesario limpiar regularmente la superficie del material. Para ello, utilice skai® limpiador o agua jabonosa caliente y suave y un paño de microfibra. No utilice blanqueadores químicos ni productos de limpieza abrasivos. Tenga en cuenta que las manchas por decoloración en el material causadas por pantalones vaqueros u otros tejidos quedan excluidas de cualquier garantía.

**Advertencias especiales**

Las recomendaciones de aplicaciones técnicas que ofrecemos, ya sea de palabra o por escrito, en base a nuestra experiencia y conforme a los avances tecnológicos actuales, no son vinculantes. En ningún caso eximirán al comprador de comprobar por sí mismo y bajo su propia responsabilidad la idoneidad de nuestros productos para la finalidad de uso prevista. Esto se aplica especialmente para todos aquellos componentes que se utilicen junto con nuestro producto y su compatibilidad al combinarlos. En todo lo demás, se aplicarán nuestras condiciones generales, lo que supone la nulidad de cualquier otro acuerdo previo.



\* nach den gesetzlichen Bestimmungen prescribed by law de conformidad con las disposiciones legales





**Continental**   
The Future in Motion



**skai® Sotega**  
Leather Design EN

Hochwertiger skai® Polsterbezugsstoff in Softnappaqualität mit klassischer Ledernarbung. Durch seine naturgetreue Optik und Haptik ist das Material von Echtleder kaum zu unterscheiden.

High quality skai® upholstery fabric with soft nappa finish and a classic leather grain. Due to its natural look and touch one can hardly differentiate between this material and genuine leather.

Un material de tapizado skai® de alta calidad con sensaciones de napa flexible y un grano de cuero clásico. Gracias a su estética y su tacto naturales, este material apenas se distingue del cuero auténtico.



skai® Sotega forest F5070763



weiss F5070646 lightgrey F5071019 silvergrey F5071020 denim F5071189

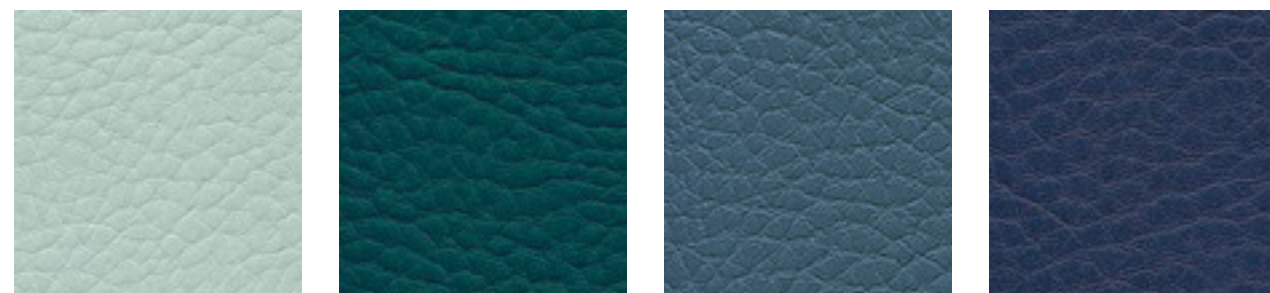

taube F5070694 petrol F5070823 azurblau F5071190 ocean F5070642

skai® Sotega



arancio F5070639 lachs F5070910 flame F5070637 kirsche F5070680



cyclam F5071126 amethyst F5070912 carmin F5070638 bordeaux F5070677



hellbeige F5070645 sandbeige F5071065 beige F5071173 kiesel F5071090



perle F5070911 sand F5071187 birke F5070767 fango F5071091



lichtgrau F5071191 platin F5071021 anthrazit F5070676 schwarz F5070643

skai® Sotega

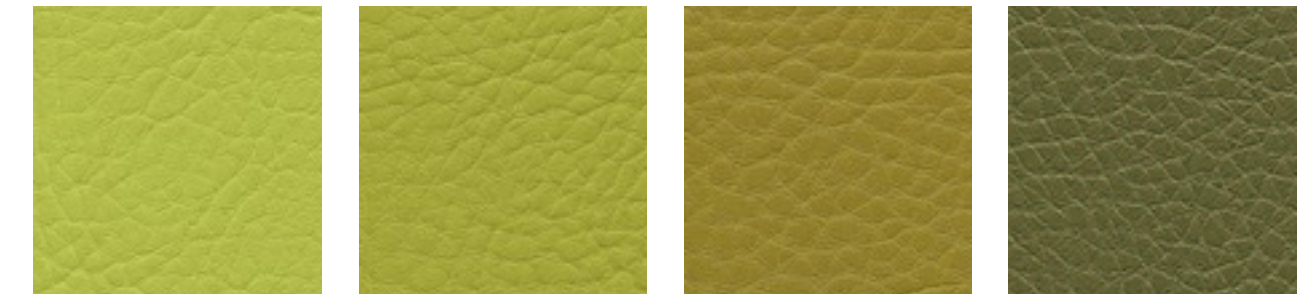

lightolive F5071016 limone F5071017 olive F5071125 taiga F5071188



camel F5070635 sattel F5070647 nature F5071124 fuchsgold F5070693



safran F5070909 mango F5070636 sherry F5070644 marone F5070640



smoke F5070835 hazelnut F5071174 mocca F5070641 schoko F5070679



Public Area



Hospitality



Residential

**Materialzusammensetzung:**

ca. 1 % PU-Finish  
ca. 73 % PVC-Compound  
ca. 26 % BW-Gewebe  
**Gewicht:** 780 +/- 50 g/m<sup>2</sup>  
**Dicke:** 1,7 +/- 0,2 mm  
**Rollenbreite:** 150 cm  
**Rollenlänge:** 30 m

**Material composition:**

approx. 1 % PU-finish  
approx. 73 % PVC-compound  
approx. 26 % CO-fabric  
**Weight:** 780 +/- 50 g/m<sup>2</sup>  
**Thickness:** 1.7 +/- 0.2 mm  
**Roll width:** 150 cm  
**Roll length:** 30 m

**Composición del material:**

aprox. 1 % de acabado de PU  
aprox. 73 % compuesto de PVC  
aprox. 26 % soporte textil de algodón  
**Peso:** 780 +/- 50 g/m<sup>2</sup>  
**Espesor:** 1,7 +/- 0,2 mm  
**Ancho de rollo:** 150 cm  
**Largo de rollo:** 30 m



langlebig  
long-lasting  
larga vida útil



reißfest  
tear resistant  
resistente al desgarro



pflegeleicht  
easy to clean  
fácil mantenimiento



abriebfest  
abrasion resistant  
resistencia a la abrasión  
**DIN EN ISO 5470-2:**  
≥ 200 000 Martindale  
invers/inverse/inverso



lichtecht  
lightfast  
resistente a la luz



vegan  
vegan  
vegano



lösungsmittelfrei  
solvent free  
exento de solvente

**Anwendung / Verarbeitung**

Geeignet für viele Arten von Bepolsterungen und Spannungen in der Polsterindustrie, besonders für den Einsatz im trendorientierten und exklusiven Wohnbereich. Ebenfalls geeignet für den Einsatz in der Taschen- und Lederwarenindustrie. Problemlose Verarbeitung nach den üblichen Verfahren (Nähen, Heften, Kleben, Nageln). Keine eingefärbten Kleber oder Lösemittelkleber verwenden!

**Sonstige Hinweise**

Zum Erhalt der Materialeigenschaften Ihres skai® Produktes ist eine regelmäßige Reinigung der Materialoberfläche erforderlich. Benutzen Sie hierzu eine warme, milde Seifenlauge und ein Mikrofasertuch oder eine weiche Handbürste. Bitte verwenden Sie keine chemischen Bleichen oder scheuernde Reinigungsmittel. Bitte beachten Sie, dass Anfärbungen des Materials durch Jeans oder andere Textilien von jeglicher Gewährleistung ausgenommen sind.

**Besondere Hinweise**

Unsere anwendungstechnischen Empfehlungen in Wort und Schrift, die wir aufgrund unserer Erfahrung entsprechend dem aktuellen Stand der Technik weitergeben, sind unverbindlich. Sie entbinden den Käufer nicht davon, die Eignung unsere Produkte für den vorgesehenen Verwendungszweck in eigener Verantwortung selbst zu prüfen. Dies gilt insbesondere für alle Komponenten, die zusammen mit unserem Produkt verarbeitet werden und deren Verträglichkeit im Verbund. Im Übrigen gelten unsere allgemeinen Geschäftsbedingungen. Hiermit verlieren alle früheren, anderslautenden Regelungen ihre Gültigkeit.

**Application / Processing**

Suitable for many kinds of upholsteries and coverings in the upholstery industry. Especially suitable in the modern and exclusive residential area. Also suitable for the use in the bags and leather goods industry. Problem-free processing in the usual procedures (sewing, tacking, sticking, nailing). Do not use colored adhesives or solvent adhesives!

**Other instructions**

To maintain the material properties of your skai® product, it is necessary to regularly clean the material surface. Use a warm, mild soap solution and a microfiber cloth or a soft hand brush for this purpose. Please do not use chemical bleach or abrasive cleaning agents. Please note that staining of the material through jeans or other textiles is excluded from any warranty.

**Special notes**

Our spoken and written application engineering recommendations, which we pass on based on our experience and in accordance with the current state of the art, are non-binding. They do not absolve buyers of their own responsibility to check the suitability of our products for the intended purpose. This applies in particular to all components that are processed together with our product and their compatibility in combination with each other. Otherwise, our general terms and conditions are in effect. All earlier provisions to the contrary hereby become invalid.

**Aplicaciones / Manipulación**

Adecuado para numerosos tipos de tapizados y revestimientos en el sector de la tapicería, especialmente para su uso en el ámbito residencial y de diseño exclusivo y de tendencia. Igualmente adecuado para su uso en la fabricación de bolsos y maletas y en marroquinería. Aplicación sencilla por medio de procedimientos habituales (cosido, hilvanado, pegado, clavado). ¡No utilizar adhesivos tintados ni a base de disolventes!

**Otros consejos**

Para conservar las propiedades del material de su producto de skai® es necesario limpiar regularmente la superficie del material. Utilice para ello lejía jabonosa suave y tibia con un paño de microfibra o un cepillo de mano suave. No utilice blanqueadores químicos ni productos de limpieza abrasivos. Tenga en cuenta que las manchas por decoloración en el material causadas por pantalones vaqueros u otros tejidos quedan excluidas de cualquier garantía.

**Advertencias especiales**

Las recomendaciones de aplicaciones técnicas que ofrecemos, ya sea de palabra o por escrito, en base a nuestra experiencia y conforme a los avances tecnológicos actuales, no son vinculantes. En ningún caso eximirán al comprador de comprobar por sí mismo y bajo su propia responsabilidad la idoneidad de nuestros productos para la finalidad de uso prevista. Esto se aplica especialmente para todos aquellos componentes que se utilicen junto con nuestro producto y su compatibilidad al combinarlos. En todo lo demás, se aplicarán nuestras condiciones generales, lo que supone la nulidad de cualquier otro acuerdo previo.



\* nach den gesetzlichen Bestimmungen prescribed by law de conformidad con las disposiciones legales



**Continental**   
The Future in Motion



**skai® Sotega Stars**  
Leather Design EN



# Sotega Stars



skai® Sotega Stars ist ein hochwertiger Polsterbezugstoff mit einer feingliedrigen Lederstruktur und einer sehr attraktiven Optik. Das Material ist besonders weich und ähnelt sehr einem hochwertigen Nappaleder. Die edle Metallic-Optik vermittelt Modernität, Eleganz und Anmut.

skai® Sotega Stars is a high-quality upholstery material with a fine leather structure and a very attractive look. The material is particularly soft and very similar to high-quality nappa leather. The fine metallic look conveys modernity, elegance and charm.

skai® Sotega Stars es un material de tapizado de alta calidad dotado de un delicado grano de cuero y una estética muy atractiva. Se trata de un material especialmente flexible y se asemeja tremendamente a una napa de alta calidad. Su cuidada estética metálica le aporta modernidad, elegancia y distinción.



skai® Sotega Stars platino F5071001



pearl F5071004



bronze F5070999



brass F5071000



flint F5071002



Hospitality



Residential

**Materialzusammensetzung:**

ca. 2 % PU-Finish  
 ca. 73 % PVC-Compound  
 ca. 25 % BW-Gewebe  
**Gewicht:** 780 +/- 50 g/m<sup>2</sup>  
**Dicke:** 1,7 +/- 0,2 mm  
**Rollenbreite:** 150 cm  
**Rollenlänge:** 30 m

**Material composition:**

approx. 2 % PU-finish  
 approx. 73 % PVC-compound  
 approx. 25 % CO-fabric  
**Weight:** 780 +/- 50 g/m<sup>2</sup>  
**Thickness:** 1.7 +/- 0.2 mm  
**Roll width:** 150 cm  
**Roll length:** 30 m

**Composición del material:**

aprox. 2 % de acabado de PU  
 aprox. 73 % compuesto de PVC  
 aprox. 25 % soporte textil de algodón  
**Peso:** 780 +/- 50 g/m<sup>2</sup>  
**Espesor:** 1,7 +/- 0,2 mm  
**Ancho de rollo:** 150 cm  
**Largo de rollo:** 30 m



langlebig  
 long-lasting  
 larga vida útil



reißfest  
 tear resistant  
 resistente al desgarro



abriebfest  
 abrasion resistant  
 resistencia a la abrasión  
**DIN EN ISO 5470-2:**  
**≥ 50 000 Martindale**  
**invers/inverse/inverso**



pflegeleicht  
 easy to clean  
 fácil mantenimiento



vegan  
 vegan  
 vegano



lichtecht  
 lightfast  
 resistente a la luz



lösungsmittelfrei  
 solvent free  
 exento de solvente

**Anwendung / Verarbeitung**

Geeignet für viele Arten von Bepolsterungen und Bespannungen im trendorientierten und exklusiven Wohnbereich. Besonders geeignet für den dekorativen Einsatz ohne übermäßige mechanische Beanspruchung. Problemlose Verarbeitung nach den üblichen Verfahren (Nähen, Heften, Kleben, Nageln). Keine eingefärbten Kleber oder Lösemittelkleber verwenden!

**Sonstige Hinweise**

Zum Erhalt der Materialeigenschaften Ihres skai® Produktes ist eine regelmäßige Reinigung der Materialoberfläche erforderlich. Benutzen Sie hierzu eine warme, milde Seifenlauge und ein Mikrofaser Tuch oder eine weiche Handbürste. Bitte verwenden Sie keine chemischen Bleichen oder scheuernde Reinigungsmittel. Bitte beachten Sie, dass Anfärbungen des Materials durch Jeans oder andere Textilien von jeglicher Gewährleistung ausgenommen sind.

**Besondere Hinweise**

Unsere anwendungstechnischen Empfehlungen in Wort und Schrift, die wir aufgrund unserer Erfahrung entsprechend dem aktuellen Stand der Technik weitergeben, sind unverbindlich. Sie entbinden den Käufer nicht davon, die Eignung unsere Produkte für den vorgesehenen Verwendungszweck in eigener Verantwortung selbst zu prüfen. Dies gilt insbesondere für alle Komponenten, die zusammen mit unserem Produkt verarbeitet werden und deren Verträglichkeit im Verbund. Im Übrigen gelten unsere allgemeinen Geschäftsbedingungen. Hiermit verlieren alle früheren, anderslautenden Regelungen ihre Gültigkeit.

**Application / Processing**

Suitable for many kinds of upholsteries and coverings in the modern and exclusive residential area. Especially suitable for decorative applications without too much mechanical wear. Problem-free processing in the usual procedures (sewing, tacking, sticking, nailing). Do not use colored adhesives or solvent adhesives!

**Other instructions**

To maintain the material properties of your skai® product, it is necessary to regularly clean the material surface. Use a warm, mild soap solution and a microfiber cloth or a soft hand brush for this purpose. Please do not use chemical bleach or abrasive cleaning agents. Please note that staining of the material through jeans or other textiles is excluded from any warranty.

**Special notes**

Our spoken and written application engineering recommendations, which we pass on based on our experience and in accordance with the current state of the art, are non-binding. They do not absolve buyers of their own responsibility to check the suitability of our products for the intended purpose. This applies in particular to all components that are processed together with our product and their compatibility in combination with each other. Otherwise, our general terms and conditions are in effect. All earlier provisions to the contrary hereby become invalid.

**Aplicaciones / Manipulación**

Adecuado para numerosos tipos de tapizados y revestimientos en el ámbito residencial exclusivo y de tendencia. Especialmente adecuado para usos decorativos sin alta abrasión. Aplicación sencilla por medio de procedimientos habituales (cosido, hilvanado, pegado, clavado). ¡No utilizar adhesivos tintados ni a base de disolventes!

**Otros consejos**

Para conservar las propiedades del material de su producto de skai® es necesario limpiar regularmente la superficie del material. Utilice para ello lejía jabonosa suave y tibia con un paño de microfibra o un cepillo de mano suave. No utilice blanqueadores químicos ni productos de limpieza abrasivos. Tenga en cuenta que las manchas por decoloración en el material causadas por pantalones vaqueros u otros tejidos quedan excluidas de cualquier garantía.

**Advertencias especiales**

Las recomendaciones de aplicaciones técnicas que ofrecemos, ya sea de palabra o por escrito, en base a nuestra experiencia y conforme a los avances tecnológicos actuales, no son vinculantes. En ningún caso eximirán al comprador de comprobar por sí mismo y bajo su propia responsabilidad la idoneidad de nuestros productos para la finalidad de uso prevista. Esto se aplica especialmente para todos aquellos componentes que se utilicen junto con nuestro producto y su compatibilidad al combinarlos. En todo lo demás, se aplicarán nuestras condiciones generales, lo que supone la nulidad de cualquier otro acuerdo previo.



\* nach den gesetzlichen Bestimmungen prescribed by law de conformidad con las disposiciones legales





**Continental**  
The Future in Motion



**skai® Sorrento EN, skai® Soroma EN**  
Leather Design EN

Der hochwertige Polsterbezugstoff skai® Sorrento EN hat eine feine Kalbsledernarbung, die ihm eine äußerst attraktive, ja beinahe würdevolle Optik verleiht. Seine mattglänzende Oberfläche und seine außergewöhnliche Weichheit geben dem Material eine elegante, natürliche Lebendigkeit. Die angenehme Haptik verführt zum Berühren.

The upholstery material skai® Sorrento EN has a fine calf leather grain and therefore a very attractive, almost dignified look. Its semi-gloss and its extraordinary softness give the material an elegant, natural vitality. The very pleasant haptics seduces the observer to touch the material.

El material de tapizado de alta calidad skai® Sorrento EN presenta un fino grano de piel de ternero que emana nobleza y le otorga una estética especialmente atractiva. Su superficie en mate-brillo y su excepcional elasticidad llenan de vida natural y elegancia a este material. Su agradable superficie es todo un placer para el tacto.



**skai® Sorrento EN** birch F5076077

skai® Soroma EN ist ein hochwertiger Polsterbezugstoff mit einer attraktiven Nahtoptik. Das Design fasziniert, denn die Nähte wirken verblüffend echt. Auf skai® Soroma EN kreuzen sich virtuelle Steppnähte zu einer klassischen Rautenstruktur, welche dem Material eine besondere Eleganz und Würde verleiht.

skai® Soroma EN is a high-quality upholstery material with an attractive seam look. The design is fascinating, because the seams look and feel like they are real. skai® Soroma EN has crisscrossing virtual quilted seams that form classical rhombi, which give the material a special elegance and sophistication.

skai® Soroma EN es un material para tapizado de alta calidad con una atractiva estética cosida. La fascinación de su diseño emana de la sorprendente fidelidad con la que se imitan las costuras. En skai® Soroma EN se entrecruzan respuntes virtuales sobre una estructura de rombos, para otorgar al material una especial elegancia y grandeza.



**skai® Soroma EN** birch F5076090

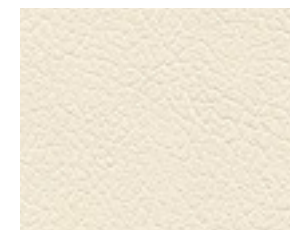

lightbeige F5076076

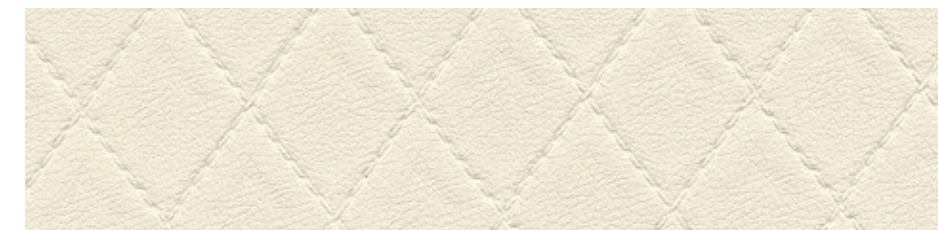

lightbeige F5076088



birch F5076077

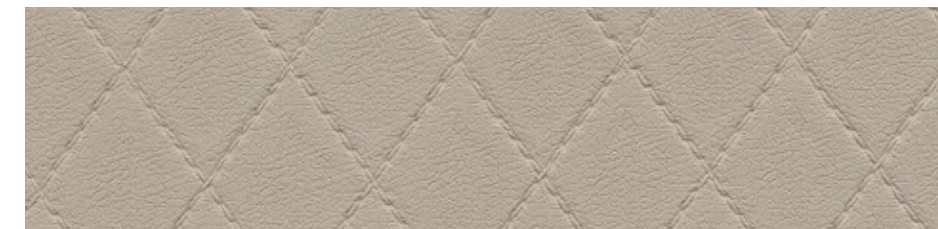

birch F5076090



fango F5076078



fango F5076092

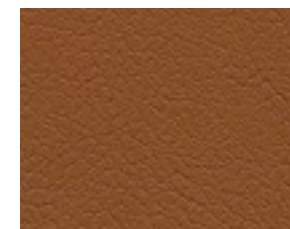

cognac F5076087

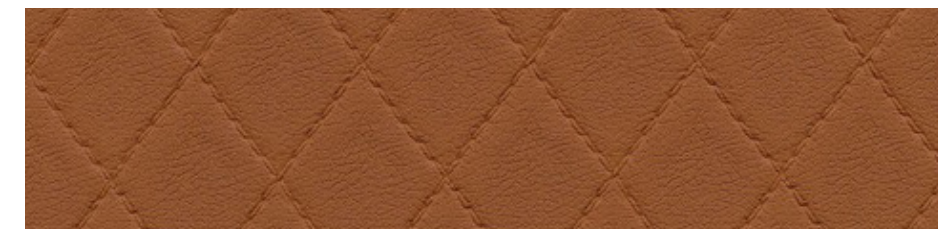

cognac F5076089

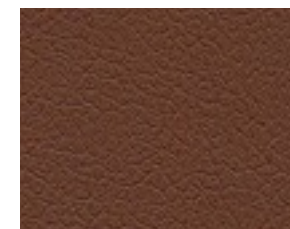

marone F5076079

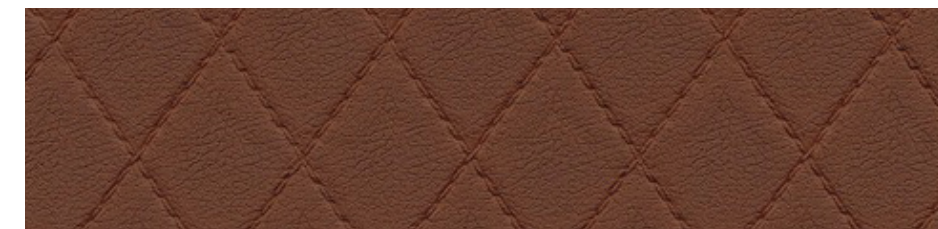

marone F5076091

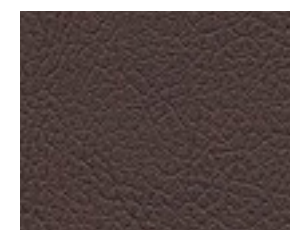

choco F5076080

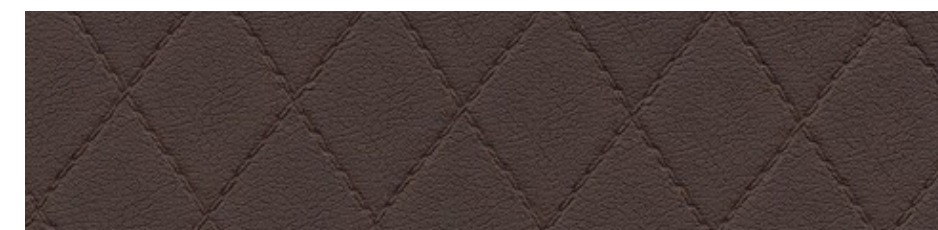

choco F5076093



slate F5076082



slate F5076094

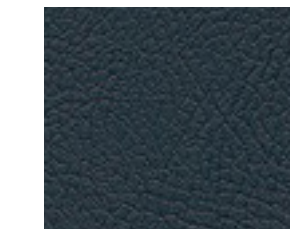

navy F5076083

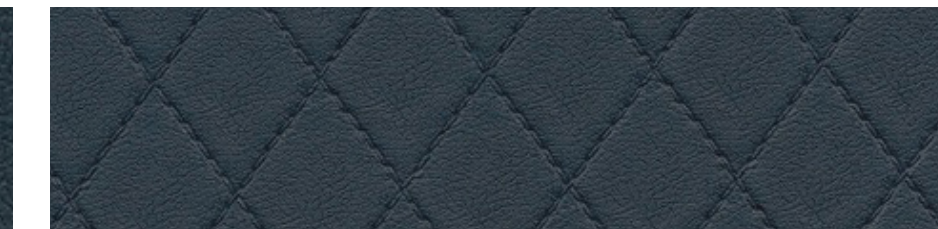

navy F5076095

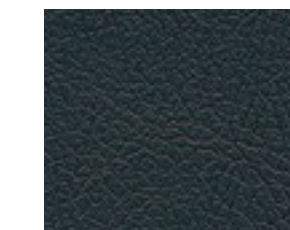

black F5076081

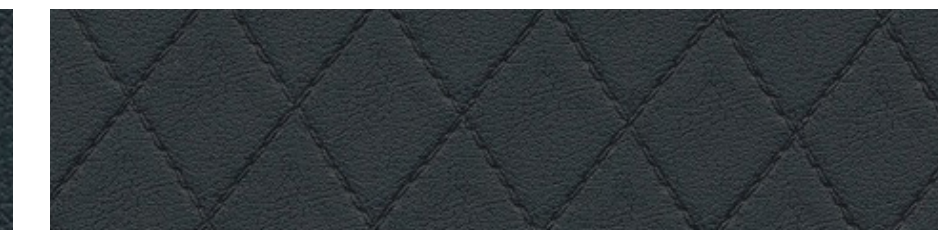

black F5076096





Public Area



Hospitality



Residential

#### Materialzusammensetzung:

ca. 1 % PU-Finish  
ca. 74 % PVC-Compound  
ca. 25 % BW-Gewebe  
**Gewicht:** 780 +/- 50 g/m<sup>2</sup>  
**Dicke:** 1,6 +/- 0,2 mm  
**Rollenbreite:** 150 cm  
**Rollenlänge:** 30m

#### Material composition:

approx. 1 % PU-finish  
approx. 74 % PVC-compound  
approx. 25 % CO-fabric  
**Weight:** 780 +/- 50 g/m<sup>2</sup>  
**Thickness:** 1.6 +/- 0.2 mm  
**Roll width:** 150cm  
**Roll length:** 30m

#### Composición del material:

aprox. 1 % de acabado de PU  
aprox. 74 % compuesto de PVC  
aprox. 25 % soporte textil de algodón  
**Peso:** 780 +/- 50 g/m<sup>2</sup>  
**Espesor:** 1,6 +/- 0,2 mm  
**Ancho de rollo:** 150cm  
**Largo de rollo:** 30m



langlebig  
long-lasting  
larga vida útil



reißfest  
tear resistant  
resistente al desgarro



abriebfest  
abrasion resistant  
resistencia a la abrasión  
**DIN EN ISO 5470-2:**  
**Sorrento EN:**  
≥ 100 000 Martindale  
**invers/inverse/inverso**  
**Soroma EN:**  
≥ 50 000 Martindale  
**invers/inverse/inverso**



schwer entflammbar  
flame protection  
resistencia al fuego  
**DIN EN 1021-1+2,**  
**BS 5852 IS-0+1, MVSS302**



pflegeleicht  
easy to clean  
fácil mantenimiento



lichtecht  
lightfast  
resistente a la luz



**0161/2023**  
IMO FTPC 2010 Part 8



lösungsmittelfrei  
solvent free  
exento de solvente



vegan  
vegan  
vegano

#### Anwendung / Verarbeitung

Geeignet für viele Arten von Bepolsterungen und Bespannungen im trendorientierten und exklusiven Wohnbereich, in öffentlichen Gebäuden und Einrichtungen. Ebenfalls geeignet für dekorative Anwendungen wie z.B. Bettkopfteile, Kissen und Wandbespannungen. Problemlose Verarbeitung nach den üblichen Verfahren (Nähen, Heften, Kleben, Nageln). Keine eingefärbten Kleber oder Lösemittelkleber verwenden!

#### Sonstige Hinweise

Zum Erhalt der Materialeigenschaften Ihres skai® Produktes ist eine regelmäßige Reinigung der Materialoberfläche erforderlich. Benutzen Sie hierzu den skai® Reiniger oder eine warme, milde Seifenlauge und ein Mikrofasertuch. Bitte verwenden Sie keine chemischen Bleichmittel oder scheuernde Reinigungsmittel. Bitte beachten Sie, dass Anfärbungen des Materials durch Jeans oder andere Textilien von jeglicher Gewährleistung ausgenommen sind.

#### Besondere Hinweise

Unsere anwendungstechnischen Empfehlungen in Wort und Schrift, die wir aufgrund unserer Erfahrung entsprechend dem aktuellen Stand der Technik weitergeben, sind unverbindlich. Sie entbinden den Käufer nicht davon, die Eignung unsere Produkte für den vorgesehenen Verwendungszweck in eigener Verantwortung selbst zu prüfen. Dies gilt insbesondere für alle Komponenten, die zusammen mit unserem Produkt verarbeitet werden und deren Verträglichkeit im Verbund. Im Übrigen gelten unsere allgemeinen Geschäftsbedingungen. Hiermit verlieren alle früheren, anderslautenden Regelungen ihre Gültigkeit.

#### Application / Processing

Suitable for many kinds of upholsteries and coverings in the modern and exclusive residential and contract area. As well suitable for decorative applications such as headboards, cushions and wall coverings. Problem-free processing in the usual procedures (sewing, tacking, sticking, nailing). Do not use colored adhesives or solvent adhesives!

#### Other instructions

To maintain the material properties of your skai® product, it is necessary to regularly clean the material surface. For cleaning, please use skai® cleaning agent or a warm, mild soapy water and a microfiber cloth. Please do not use chemical bleach or abrasive cleaning agents. Please note that staining of the material through jeans or other textiles is excluded from any warranty.

#### Special notes

Our spoken and written application engineering recommendations, which we pass on based on our experience and in accordance with the current state of the art, are non-binding. They do not absolve buyers of their own responsibility to check the suitability of our products for the intended purpose. This applies in particular to all components that are processed together with our product and their compatibility in combination with each other. Otherwise, our general terms and conditions are in effect. All earlier provisions to the contrary hereby become invalid.

#### Aplicaciones / Manipulación

Adecuado para numerosos tipos de tapizados y revestimientos, especialmente para su uso en el ámbito residencial exclusivo y de tendencia y en instalaciones y edificios públicos. Especialmente adecuado para aplicaciones decorativas, tales como cabeceros, cojines y revestimientos de pared. Aplicación sencilla por medio de procedimientos habituales (cosido, hilvanado, pegado, clavado). ¡No utilizar adhesivos tintados ni a base de disolventes!

#### Otros consejos

Para conservar las propiedades del material de su producto de skai® es necesario limpiar regularmente la superficie del material. Para ello, utilice skai® limpiador o agua jabonosa caliente y suave y un paño de microfibra. No utilice blanqueadores químicos ni productos de limpieza abrasivos. Tenga en cuenta que las manchas por decoloración en el material causadas por pantalones vaqueros u otros tejidos quedan excluidas de cualquier garantía.

#### Advertencias especiales

Las recomendaciones de aplicaciones técnicas que ofrecemos, ya sea de palabra o por escrito, en base a nuestra experiencia y conforme a los avances tecnológicos actuales, no son vinculantes. En ningún caso eximirán al comprador de comprobar por sí mismo y bajo su propia responsabilidad la idoneidad de nuestros productos para la finalidad de uso prevista. Esto se aplica especialmente para todos aquellos componentes que se utilicen junto con nuestro producto y su compatibilidad al combinarlos. En todo lo demás, se aplicarán nuestras condiciones generales, lo que supone la nulidad de cualquier otro acuerdo previo.



\* nach den gesetzlichen Bestimmungen prescribed by law de conformidad con las disposiciones legales



**Continental**   
The Future in Motion



**skai® Sarano**  
Leather Design EN



# Sarano



Hochwertiges skai® Material mit ausdrucksstarker Rindslederoptik. Der harmonische 2-Ton-Effekt verleiht dem Material eine natürliche Lebendigkeit.

High-quality skai® material with expressive cowhide grain. The harmonic 2-tone-effect lends the material its natural vividness.

Un material skai® de alta calidad con una expresiva estética de cuero de vacuno. Su armónico efecto bitono llena este material de vida y naturalidad.



**skai® Sarano** buffalo F5075020



sand F5075016



camel F5075019

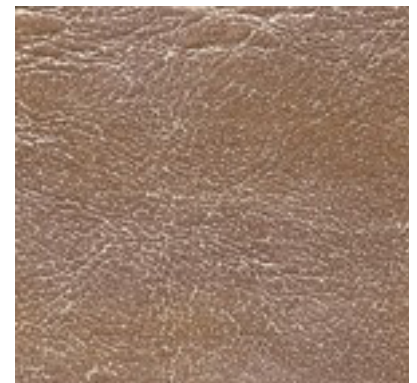

natur F5075018

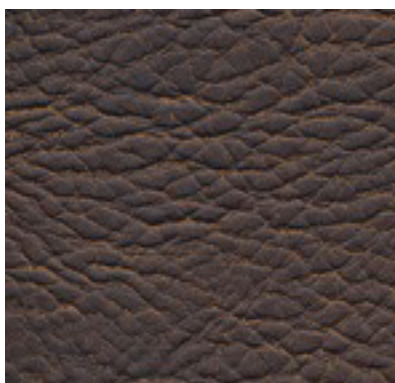

schoko F5075021

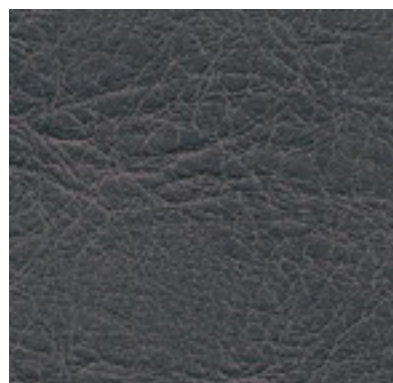

anthrazit F5075022



Hospitality



Residential

**Materialzusammensetzung:**

ca. 1 % PU-Finish  
 ca. 66 % PVC-Compound  
 ca. 33 % BW-Gewebe  
**Gewicht:** 610 +/- 50 g/m<sup>2</sup>  
**Dicke:** 1,5 +/- 0,2mm  
**Rollenbreite:** 150cm  
**Rollenlänge:** 30m

**Material composition:**

approx. 1 % PU-finish  
 approx. 66 % PVC-compound  
 approx. 33 % CO-fabric  
**Weight:** 610 +/- 50 g/m<sup>2</sup>  
**Thickness:** 1.5 +/- 0.2 mm  
**Roll width:** 150cm  
**Roll length:** 30m

**Composición del material:**

aprox. 1 % de acabado de PU  
 aprox. 66 % compuesto de PVC  
 aprox. 33 % soporte textil de algodón  
**Peso:** 610 +/- 50 g/m<sup>2</sup>  
**Espesor:** 1,5 +/- 0,2mm  
**Ancho de rollo:** 150cm  
**Largo de rollo:** 30m



langelig  
 long-lasting  
 larga vida útil



reißfest  
 tear resistant  
 resistente al desgarro



abriebfest  
 abrasion resistant  
 resistencia a la abrasión  
**DIN EN ISO 5470-2:**  
**≥ 75 000 Martindale**  
 invers/inverse/inverso



schwer entflammbar  
 flame protection  
 resistencia al fuego  
**DIN EN 1021-1+2,**  
**BS 5852 IS-0+1**



pflegeleicht  
 easy to clean  
 fácil mantenimiento



lichtecht  
 lightfast  
 resistente a la luz



lösungsmittelfrei  
 solvent free  
 exento de solvente



vegan  
 vegan  
 vegane

**Anwendung / Verarbeitung**

Geeignet für viele Arten von Bepolsterungen und Bespannungen im trendorientierten und exklusiven Wohnbereich, besonders geeignet für Dekokissen, Korpus- und Wandbespannungen ohne starke mechanische Beanspruchung. Ebenfalls geeignet für den Einsatz in der Taschen- und Lederwarenindustrie. Problemlose Verarbeitung nach den üblichen Verfahren (Nähen, Heften, Kleben, Nageln). Keine eingefärbten Kleber oder Lösemittelkleber verwenden!

**Sonstige Hinweise**

Zum Erhalt der Materialeigenschaften Ihres skai® Produktes ist eine regelmäßige Reinigung der Materialoberfläche erforderlich. Benutzen Sie hierzu eine warme, milde Seifenlauge und ein Mikrofasertuch oder eine weiche Handbürste. Bitte verwenden Sie keine chemischen Bleichen oder scheuernde Reinigungsmittel. Bitte beachten Sie, dass Anfärbungen des Materials durch Jeans oder andere Textilien von jeglicher Gewährleistung ausgenommen sind.

**Besondere Hinweise**

Unsere anwendungstechnischen Empfehlungen in Wort und Schrift, die wir aufgrund unserer Erfahrung entsprechend dem aktuellen Stand der Technik weitergeben, sind unverbindlich. Sie entbinden den Käufer nicht davon, die Eignung unsere Produkte für den vorgesehenen Verwendungszweck in eigener Verantwortung selbst zu prüfen. Dies gilt insbesondere für alle Komponenten, die zusammen mit unserem Produkt verarbeitet werden und deren Verträglichkeit im Verbund. Im Übrigen gelten unsere allgemeinen Geschäftsbedingungen. Hiermit verlieren alle früheren, anderslautenden Regelungen ihre Gültigkeit.

**Application / Processing**

Suitable for many kinds of upholsteries and coverings in the modern and exclusive residential area, especially for cushions, corpus and wall coverings without too much mechanical wear. Also suitable for the use in the bags and leather goods industry. Problem-free processing in the usual procedures (sewing, tacking, sticking, nailing). Do not use colored adhesives or solvent adhesives!

**Other instructions**

To maintain the material properties of your skai® product, it is necessary to regularly clean the material surface. Use a warm, mild soap solution and a microfiber cloth or a soft hand brush for this purpose. Please do not use chemical bleach or abrasive cleaning agents. Please note that staining of the material through jeans or other textiles is excluded from any warranty.

**Special notes**

Our spoken and written application engineering recommendations, which we pass on based on our experience and in accordance with the current state of the art, are non-binding. They do not absolve buyers of their own responsibility to check the suitability of our products for the intended purpose. This applies in particular to all components that are processed together with our product and their compatibility in combination with each other. Otherwise, our general terms and conditions are in effect. All earlier provisions to the contrary hereby become invalid.

**Aplicaciones / Manipulación**

Adecuado para numerosos tipos de tapizados y revestimientos en el ámbito residencial exclusivo y de tendencia; especialmente idóneo para cojines decorativos y revestimiento de armarios y paredes sin esfuerzos mecánicos elevados. Igualmente adecuado para su uso en la fabricación de bolsos y maletas y en la marroquinería. Aplicación sencilla por medio de procedimientos habituales (cosido, hilvanado, pegado, clavado). ¡No utilizar adhesivos tintados ni a base de disolventes!

**Otros consejos**

Para conservar las propiedades del material de su producto de skai® es necesario limpiar regularmente la superficie del material. Utilice para ello lejía jabonosa suave y tibia con un paño de microfibra o un cepillo de mano suave. No utilice blanqueadores químicos ni productos de limpieza abrasivos. Tenga en cuenta que las manchas por decoloración en el material causadas por pantalones vaqueros u otros tejidos quedan excluidas de cualquier garantía.

**Advertencias especiales**

Las recomendaciones de aplicaciones técnicas que ofrecemos, ya sea de palabra o por escrito, en base a nuestra experiencia y conforme a los avances tecnológicos actuales, no son vinculantes. En ningún caso eximirán al comprador de comprobar por sí mismo y bajo su propia responsabilidad la idoneidad de nuestros productos para la finalidad de uso prevista. Esto se aplica especialmente para todos aquellos componentes que se utilicen junto con nuestro producto y su compatibilidad al combinarlos. En todo lo demás, se aplicarán nuestras condiciones generales, lo que supone la nulidad de cualquier otro acuerdo previo.



\* nach den gesetzlichen Bestimmungen prescribed by law de conformidad con las disposiciones legales





**skai® Kimera EN**  
Leather Design EN

Hochwertiges skai® Polstermaterial für universelle Anwendungen. Seine charakteristische Rindsledernarbung verhilft Möbeln und Wänden zu schlichter Eleganz. Das besonders für den Objekteinsatz geeignete Material besticht außerdem mit inneren Werten: Die Oberfläche ist besonders robust und dennoch komfortabel.

High-quality skai® upholstery material for universal use. Its characteristic cowhide grain lends furniture and walls a sleek elegance. The material, which is particularly suitable for contract use, is also impressive due to its innate values: The surface is particularly robust, yet comfortable.

Un material de tapizado skai® de alta calidad para aplicaciones universales. Su característico grano de cuero vacuno aporta a los muebles y paredes una elegancia discreta. Este material, especialmente idóneo para la decoración, convence también por sus valores intrínsecos: su superficie es especialmente robusta, pero a la vez confortable.



skai® Kimera EN hazelnut F6424015

skai® Kimera EN



white F6424001



glace F6424016



fango F6424003



sand F6424014



birch F6424002



smoke F6424017



cognac F6424004

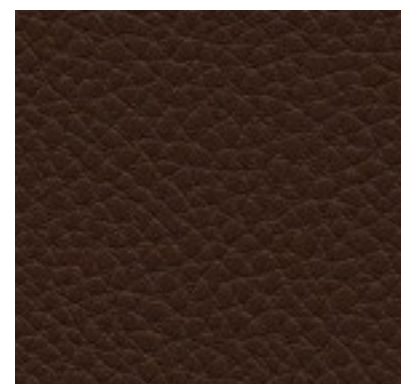

marone F6424005



humus F6424018

skai® Kimera EN



tumeric F6424021

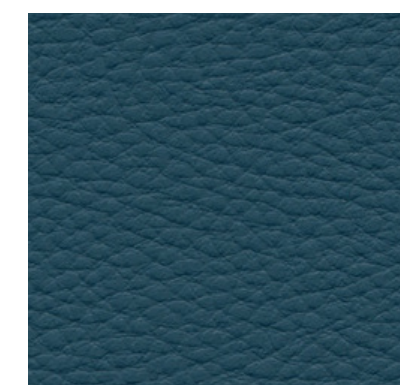

denim F6424023



choco F6424006



platinum F6424019



graphite F6424022



anthracite F6424008

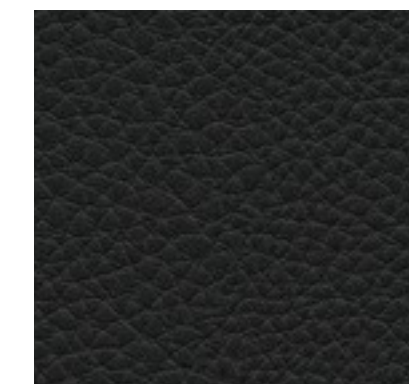

black F6424009



Public Area



Hospitality



Residential



Healthcare



Fitness

**Materialzusammensetzung:**

ca. 88% PVC-Compound  
ca. 12% PES-Gestrick  
**Gewicht:** 630 +/- 50 g/m<sup>2</sup>  
**Dicke:** 1,1 +/- 0,2mm  
**Rollenbreite:** 140cm  
**Rollenlänge:** 30m

**Material composition:**

approx. 88% PVC-compound  
approx. 12% PES-knitted fabric  
**Weight:** 630 +/- 50 g/m<sup>2</sup>  
28.4 +/- 2.3 oz/lyd  
**Thickness:** 1.1 +/- 0.2 mm  
**Roll width:** 140cm / 55.1 in.  
**Roll length:** 30m / 32.8 yd

**Composición del material:**

aprox. 88% compuesto de PVC  
aprox. 12% soporte textil de PES  
**Peso:** 630 +/- 50 g/m<sup>2</sup>  
**Espesor:** 1,1 +/- 0,2mm  
**Ancho de rollo:** 140cm  
**Largo de rollo:** 30m



langlebig  
long-lasting  
larga vida útil



reifest  
tear resistant  
resistente al desgarro



abriebfest  
abrasion resistant  
resistencia a la abrasión  
**DIN EN ISO 5470-2:**  
**>100 000 Martindale**  
**invers/inverse/inverso**  
**ASTM D4157 / CFFA-1A:**  
**≥ 50,000**  
**Abrieb Wyzenbeek**  
**double rubs Wyzenbeek**  
**doble frota Wyzenbeek**



schwer entflammbar  
flame protection  
resistencia al fuego  
**DIN EN 1021-1+2,**  
**BS 5852 IS-O+1, MVSS302,**  
**CA TB 117-2013, UFAC/**  
**NFPA260 Class 1**



pflegeleicht  
easy to clean  
fácil mantenimiento



lichtecht  
lightfast  
resistente a la luz  
**DIN EN ISO 105-BS02,**  
**Stufe 5, level 5, nivel 5**



lsungsmittelfrei  
solvent free  
exento de solvente



vegan  
vegan  
vegano

**Anwendung / Verarbeitung**

Geeignet fr viele Arten von Bepolsterungen und Bespannungen in der Polsterindustrie. Besonders geeignet fr den Einsatz im trendorientierten Wohn- und Objektbereich, in ffentlichen Gebuden und Einrichtungen. Problemlose Verarbeitung nach den blichen Verfahren (Nhen, Heften, Kleben, Nageln). Keine eingefrbten Kleber oder Lsemittelkleber verwenden!

**Application / Processing**

Suitable for many kinds of upholsterys and coverings in the upholstery industry. Especially suitable for the use in the modern residential and contract area, in public buildings and institutions. Problem-free processing in the usual procedures (sewing, tacking, sticking, nailing). Do not use colored adhesives or solvent adhesives!

**Aplicaciones / Manipulación**

Adecuado para numerosos tipos de tapizados y revestimientos en el sector de la tapicería. Especialmente adecuado para su uso en el mbito residencial exclusivo y de tendencia y en instalaciones y edificios pblicos. Aplicacin sencilla por medio de procedimientos habituales (cosido, hilvanado, pegado, clavado). ¡No utilizar adhesivos tintados ni a base de disolventes!

**Sonstige Hinweise**

Zum Erhalt der Materialeigenschaften Ihres skai® Produktes ist eine regelmige Reinigung der Materialoberflche erforderlich. Benutzen Sie hierzu eine warme, milde Seifenlauge und ein Mikrofaser Tuch oder eine weiche Handbrste. Bitte verwenden Sie keine chemischen Bleichen oder scheuernde Reinigungsmittel. Bitte beachten Sie, dass Anfrbungen des Materials durch Jeans oder andere Textilien von jeglicher Gewhrleistung ausgenommen sind.

**Other instructions**

To maintain the material properties of your skai® product, it is necessary to regularly clean the material surface. Use a warm, mild soap solution and a microfiber cloth or a soft hand brush for this purpose. Please do not use chemical bleach or abrasive cleaning agents. Please note that staining of the material through jeans or other textiles is excluded from any warranty.

**Otros consejos**

Para conservar las propiedades del material de su producto de skai® es necesario limpiar regularmente la superficie del material. Utilice para ello lejía jabonosa suave y tibia con un paño de microfibra o un cepillo de mano suave. No utilice blanqueadores qumicos ni productos de limpieza abrasivos. Tenga en cuenta que las manchas por decoloracin en el material causadas por pantalones vaqueros u otros tejidos quedan excluidas de cualquier garantía.

**Besondere Hinweise**

Unsere anwendungstechnischen Empfehlungen in Wort und Schrift, die wir aufgrund unserer Erfahrung entsprechend dem aktuellen Stand der Technik weitergeben, sind unverbindlich. Sie entbinden den Kufer nicht davon, die Eignung unsere Produkte fr den vorgesehenen Verwendungszweck in eigener Verantwortung selbst zu prfen. Dies gilt insbesondere fr alle Komponenten, die zusammen mit unserem Produkt verarbeitet werden und deren Vertrglichkeit im Verbund. Im brigen gelten unsere allgemeinen Geschftsbedingungen. Hiermit verlieren alle frheren, anderslautenden Regelungen ihre Gltigkeit.

**Special notes**

Our spoken and written application engineering recommendations, which we pass on based on our experience and in accordance with the current state of the art, are non-binding. They do not absolve buyers of their own responsibility to check the suitability of our products for the intended purpose. This applies in particular to all components that are processed together with our product and their compatibility in combination with each other. Otherwise, our general terms and conditions are in effect. All earlier provisions to the contrary hereby become invalid.

**Advertencias especiales**

Las recomendaciones de aplicaciones tcnicas que ofrecemos, ya sea de palabra o por escrito, en base a nuestra experiencia y conforme a los avances tecnolgicos actuales, no son vinculantes. En ningn caso eximirn al comprador de comprobar por s mismo y bajo su propia responsabilidad la idoneidad de nuestros productos para la finalidad de uso prevista. Esto se aplica especialmente para todos aquellos componentes que se utilicen junto con nuestro producto y su compatibilidad al combinarlos. En todo lo dems, se aplicarn nuestras condiciones generales, lo que supone la nulidad de cualquier otro acuerdo previo.



\* nach den gesetzlichen Bestimmungen prescribed by law de conformidad con las disposiciones legales



DIN EN ISO 14001  
DIN EN ISO 45001  
DIN EN ISO 9001  
IATF 16949

**Continental**   
The Future in Motion

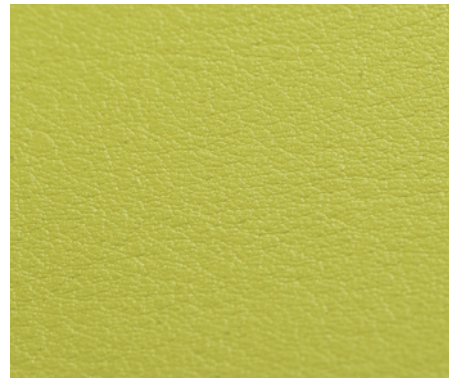

**skai® Tundra**  
Leather Design EN



Hochwertiges skai® Material mit feiner Kalbsledernarbung und dezentem Matt-Glanz-Effekt. Das sehr umfangreiche Farbspektrum ermöglicht viele Anwendungs- und Kombinationsmöglichkeiten.

High quality skai® material with fine calf leather grain and subdued matte-gloss-effect. The very extensive and trend-orientated colour spectrum enables many applications and combinations.

Un material skai® de alta calidad con el grano fino del cuero vacuno y un sutil efecto mate-brillo. Su amplísima gama de colores hace posibles numerosas posibilidades de aplicación y combinación.



skai® Tundra royal F6461196

skai® Tundra

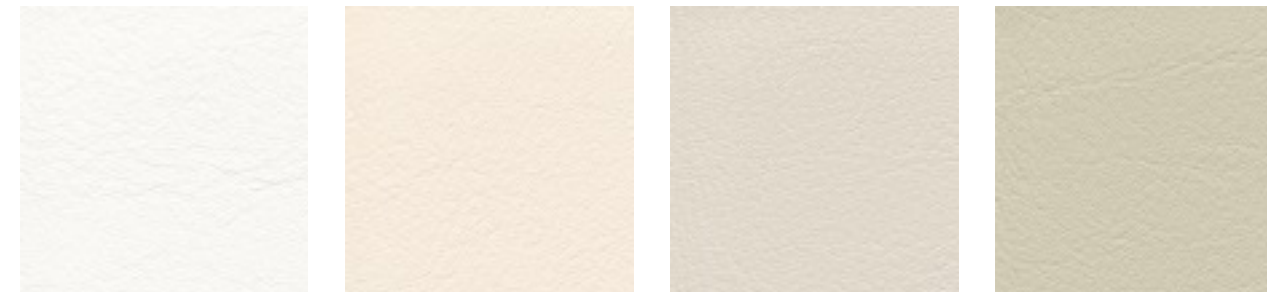

weiss F6461198 beige F6461636 creme F6461210 sand F6461230



mais F6461457 apricot F6461458 mango F6461607 safran F6461542



limonade F6461343 orange F6461556 karneol F6461557 feuer F6461454



kirsche F6461199 cyclame F6461381 orchidee F6461354 violett F6461356



pistazio F6461610 limone F6461543 apfelgrün F6461723 smaragd F6461455

skai® Tundra



mint F6461495 aqua F6461456 türkis F6461338 agave F6461273



dolphin F6461609 stone F6461608 bleu F6461496 sky F6461581



atoll F6461453 royal F6461196 ocean F6461204 bordeaux F6461350

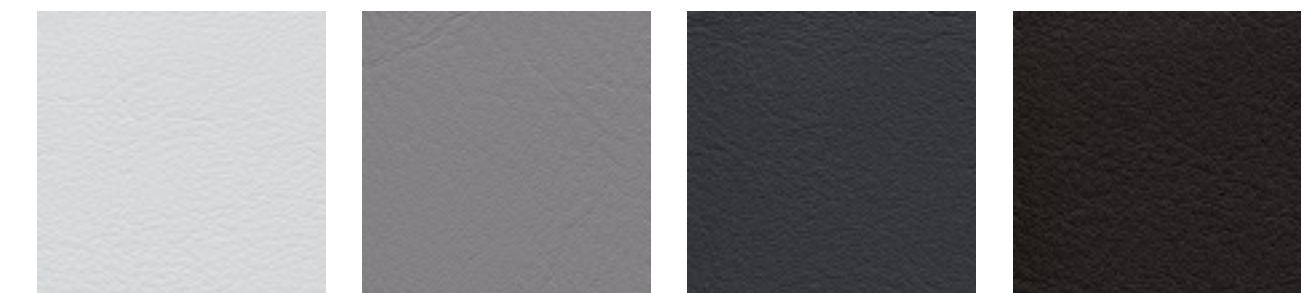

perle F6461288 chrom F6461205 anthrazit F6461197 schoko F6461357



silber F6461550 schwarz F6461195



Public Area



Hospitality



Residential



Healthcare



Fitness

**Materialzusammensetzung:**

ca. 90 % PVC-Compound  
ca. 10 % BW/PES-Gestrick  
**Gewicht:** 680 +/- 50 g/m<sup>2</sup>  
**Dicke:** 1,0 +/- 0,2 mm  
**Rollenbreite:** 137 cm  
**Rollenlänge:** 30m

**Material composition:**

approx. 90 % PVC-compound  
approx. 10 % CO/PES-knitted fabric  
**Weight:** 680 +/- 50 g/m<sup>2</sup>  
**Thickness:** 1.0 +/- 0.2 mm  
**Roll width:** 137 cm  
**Roll length:** 30m

**Composición del material:**

aprox. 90 % compuesto de PVC  
aprox. 10 % soporte textil de punto de algodón/PES  
**Peso:** 680 +/- 50 g/m<sup>2</sup>  
**Espesor:** 1,0 +/- 0,2 mm  
**Ancho de rollo:** 137 cm  
**Largo de rollo:** 30 m



langlebig  
long-lasting  
larga vida útil



reißfest  
tear resistant  
resistente al desgarro



pflegeleicht  
easy to clean  
fácil mantenimiento



abriebfest  
abrasion resistant  
resistencia a la abrasión  
**DIN EN ISO 5470-2:**  
**≥ 100 000 Martindale  
invers/inverse/inverso  
silber: ≥ 5 000 Martindale  
invers/inverse/inverso**



lichtecht  
lightfast  
resistente a la luz



desinfektionsmittelbeständig  
disinfectant resistant  
resistente a los  
desinfectantes



erfüllt Medizinproduktegesetz  
fulfills medical standard  
cumple la normativa para  
productos sanitarios  
DIN EN ISO 10993-5+10



blut- und urinbeständig  
blood- and urine resistant  
resistente a la sangre  
y a la orina



phthalatfrei  
phthalate-free  
no contiene ftalatos



vegan  
vegan  
vegano

**Anwendung / Verarbeitung**

Geeignet für viele Arten von Bepolsterungen und Bespannungen in der Polsterindustrie, besonders für den Einsatz im Medizin- und Physiotherapiebereich. Bei sachgemäßer Anwendung sind nach DIN EN ISO 10993-5 keine zytotoxischen Effekte und nach DIN EN ISO 10993-10 keine primären Hautirritationen zu erwarten. Problemlose Verarbeitung nach den üblichen Verfahren (Nähen, Heften, Kleben, Nageln). Keine eingefärbten Kleber oder Lösemittelkleber verwenden!

**Sonstige Hinweise**

Zum Erhalt der Materialeigenschaften Ihres skai® Produktes ist eine regelmäßige Reinigung der Materialoberfläche erforderlich. Benutzen Sie hierzu den skai® Reiniger oder eine warme, milde Seifenlauge und ein Mikrofasertuch. Bitte verwenden Sie keine chemischen Bleichen oder scheuernde Reinigungsmittel. Bitte beachten Sie, dass Anfärbungen des Materials durch Jeans oder andere Textilien von jeglicher Gewährleistung ausgenommen sind.

**Besondere Hinweise**

Unsere anwendungstechnischen Empfehlungen in Wort und Schrift, die wir aufgrund unserer Erfahrung entsprechend dem aktuellen Stand der Technik weitergeben, sind unverbindlich. Sie entbinden den Käufer nicht davon, die Eignung unsere Produkte für den vorgesehenen Verwendungszweck in eigener Verantwortung selbst zu prüfen. Dies gilt insbesondere für alle Komponenten, die zusammen mit unserem Produkt verarbeitet werden und deren Verträglichkeit im Verbund. Im Übrigen gelten unsere allgemeinen Geschäftsbedingungen. Hiermit verlieren alle früheren, anderslautenden Regelungen ihre Gültigkeit.

**Application / Processing**

Suitable for many kinds of upholsteries and coverings in the upholstery industry, especially for couches in the medical and physiotherapy area. By proper use no cytotoxic effects (according DIN EN ISO 10993-5) and no primary skin irritations (according DIN EN ISO 10993-10) are to be expected. Problem-free processing in the usual procedures (sewing, tacking, sticking, nailing). Do not use colored adhesives or solvent adhesives!

**Other instructions**

To maintain the material properties of your skai® product, it is necessary to regularly clean the material surface. For cleaning, please use skai® cleaning agent or a warm, mild soapy water and a microfiber cloth. Please do not use chemical bleach or abrasive cleaning agents. Please note that staining of the material through jeans or other textiles is excluded from any warranty.

**Special notes**

Our spoken and written application engineering recommendations, which we pass on based on our experience and in accordance with the current state of the art, are non-binding. They do not absolve buyers of their own responsibility to check the suitability of our products for the intended purpose. This applies in particular to all components that are processed together with our product and their compatibility in combination with each other. Otherwise, our general terms and conditions are in effect. All earlier provisions to the contrary hereby become invalid.

**Aplicaciones / Manipulación**

Adecuado para numerosos tipo de tapizados y revestimientos en el sector de la tapicería, especialmente en el ámbito de la medicina y la fisioterapia. Siempre y cuando se use correctamente, no se prevén efectos citotóxicos según la norma UNE-EN ISO 10993-5 ni irritaciones cutáneas primarias según la norma UNE-EN ISO 10993-10. Aplicación sencilla por medio de procedimientos habituales (cosido, hilvanado, pegado, clavado). ¡No utilizar adhesivos tintados ni a base de disolventes!

**Otros consejos**

Para conservar las propiedades del material de su producto de skai® es necesario limpiar regularmente la superficie del material. Para ello, utilice skai® limpiador o agua jabonosa caliente y suave y un paño de microfibra. No utilice blanqueadores químicos ni productos de limpieza abrasivos. Tenga en cuenta que las manchas por decoloración en el material causadas por pantalones vaqueros u otros tejidos quedan excluidas de cualquier garantía.

**Advertencias especiales**

Las recomendaciones de aplicaciones técnicas que ofrecemos, ya sea de palabra o por escrito, en base a nuestra experiencia y conforme a los avances tecnológicos actuales, no son vinculantes. En ningún caso eximirán al comprador de comprobar por sí mismo y bajo su propia responsabilidad la idoneidad de nuestros productos para la finalidad de uso prevista. Esto se aplica especialmente para todos aquellos componentes que se utilicen junto con nuestro producto y su compatibilidad al combinarlos. En todo lo demás, se aplicarán nuestras condiciones generales, lo que supone la nulidad de cualquier otro acuerdo previo.



\* nach den gesetzlichen Bestimmungen prescribed by law de conformidad con las disposiciones legales





**Outdoor**

**Outdoor**

**Continental**   
The Future in Motion

**skai® cool colors Collection**

Outdoor

Hochwertige skai® Polsterbezugsstoffe mit cool colors Technologie reduzieren die Aufheizung der Oberfläche bei direkter Sonneneinstrahlung und eignen sich besonders für den Outdoor-Bereich: skai® cool colors Venezia zeigt eine sportlich-elegante, skai® cool colors Vigo eine moderne Texturoptik. skai® cool colors Valero besitzt eine feine, edle Ledernarbung und ist farblich auf cool colors Vigo abgestimmt.

High-quality skai® upholstery fabrics with cool colors technology reduce heating of the surface in direct sunlight and are particularly suitable for outdoor applications: skai® cool colors Venezia features a sporty, elegant fabric appearance and skai® cool colors Vigo a modern textile look. skai® cool colors Valero has a fine, high-grade leather grain and is color-coordinated with cool colors Vigo.

Los tejidos de tapicería acolchada de alta calidad de skai® con tecnología cool colors reducen el calentamiento de la superficie bajo la luz directa del sol y son especialmente adecuados para el uso en exteriores: skai® cool colors Venezia tiene un aspecto deportivo y elegante, mientras que skai® cool colors Vigo tiene un aspecto textil moderno. skai® cool colors Valero tiene un grano de piel fino y elegante y se complementa con cool colors Vigo.

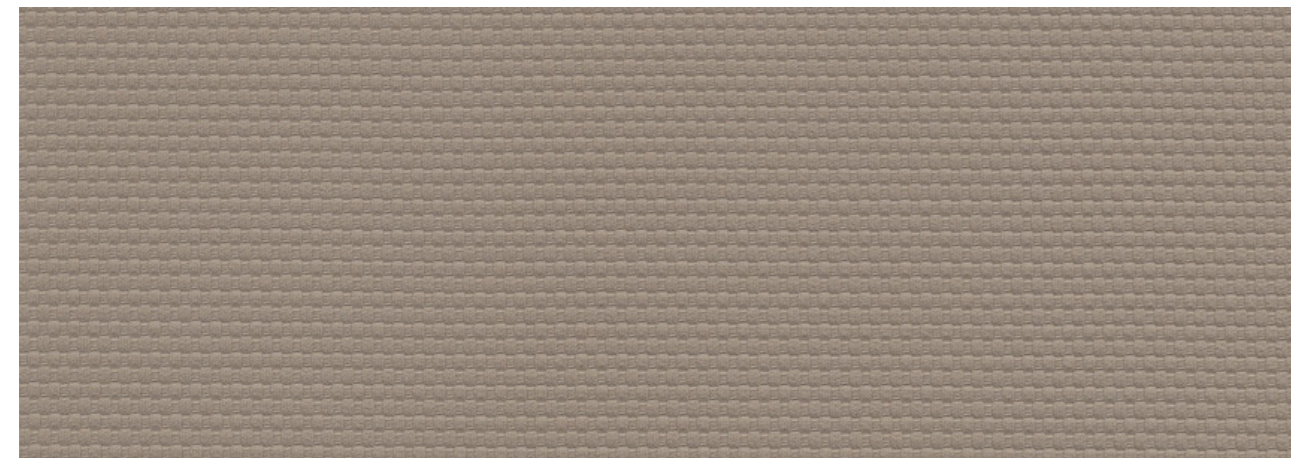

skai® cool colors Venezia cinder F6495077

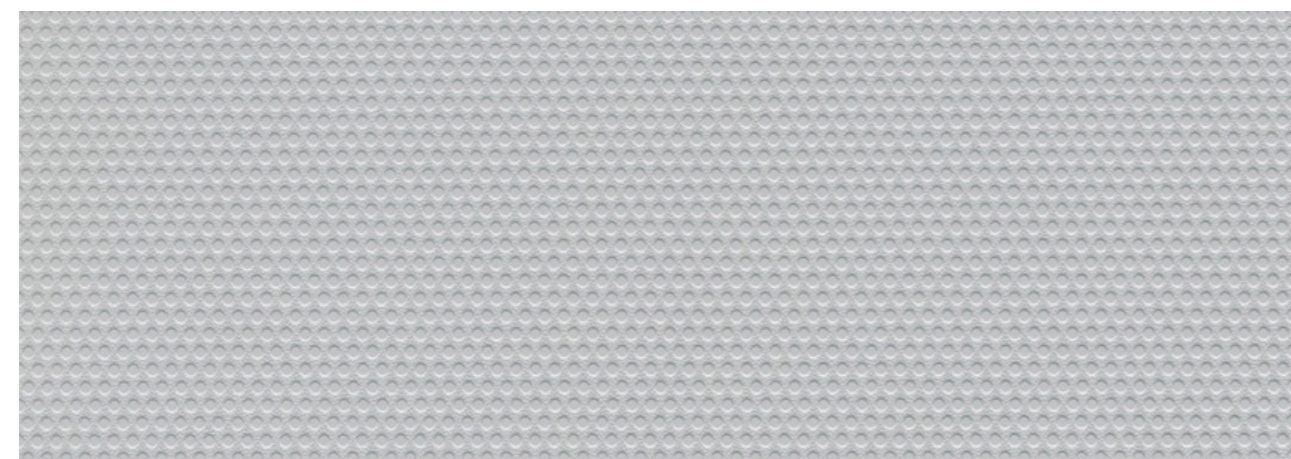

skai® cool colors Vigo lightgrey F6495057

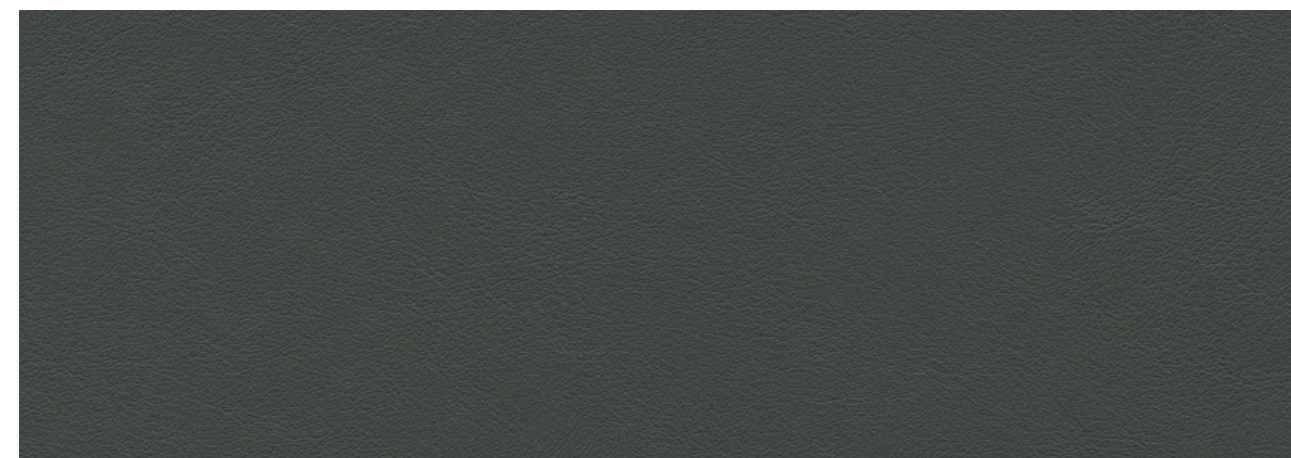

skai® cool colors Valero black F6495064

skai® cool colors Venezia



skai® cool colors Valero,  
skai® cool colors Vigo





Public Area



Hospitality



Residential



Healthcare



Outdoor



Fitness



Marine Application

**Materialzusammensetzung:**

ca. 2 % Nano-Hightec-Compound  
ca. 85 % PVC-Compound  
ca. 13 % PES-Gestrick  
**Gewicht:** 580 +/- 60 g/m<sup>2</sup>  
**Dicke:** 1,35 +/- 0,2 mm  
**Rollenbreite:** 140cm  
**Rollenlänge:** 30m

**Material composition:**

approx. 2 % Nano-Hightec-Compound  
approx. 85 % PVC compound  
approx. 13 % PES knitted fabric  
**Weight:** 580 +/- 60 g/m<sup>2</sup>  
26.2 +/- 2.7 oz/yd  
**Thickness:** 1.35 +/- 0.2 mm  
**Roll width:** 140cm / 55.1 in.  
**Roll length:** 30m / 32.8 yd

**Composición del material:**

aprox. 2 % compuesto Nano Hightech  
aprox. 85 % compuesto de PVC  
aprox. 13 % soporte textil de punto de PES  
**Peso:** 580 +/- 60 g/m<sup>2</sup>  
**Espesor:** 1,35 +/- 0,2 mm  
**Ancho de rollo:** 140cm  
**Largo de rollo:** 30m



langlebig  
long-lasting  
larga vida útil



reißfest  
tear resistant  
resistente al desgarro



pflegeleicht  
easy to clean  
fácil mantenimiento



abriebfest  
abrasion resistant  
resistencia a la abrasión  
**DIN EN ISO 5470-2:**  
≥ 100 000 Martindale  
invers/inverse/inverso  
**ASTM D4157 / CFFA-1A:**  
≥ 100 000  
**Abrieb Wyzenbeek**  
double rubs Wyzenbeek  
doble frota Wyzenbeek



UV-beständig  
UV resistant  
resistente a la radiación UV



bewitterungsstabil  
weather resistance  
estable ante los  
resistencia ante los factores  
mediambientales



desinfektionsmittelbeständig  
disinfectant resistant  
resistente a los desinfectantes



blut- und urinbeständig  
blood- and urine resistant  
resistente a la sangre  
y a la orina



salzwasserbeständig und  
chlorwasserbeständig  
salt water and chlorine  
water resistant  
resistente al agua salada  
y al agua clorada



**0161/2023**  
IMO FTPC 2010 Part 8



schwer entflammbar  
flame protection  
resistencia al fuego  
**DIN EN 1021-1+2,**  
**BS 5852 IS-0+1,**  
**CA TB 117-2013, UFAC/**  
**NFPA260 Class 1**



ölbeständig  
oil resistant  
resistente a los aceites



vegan  
vegan  
vegano

**Anwendung / Verarbeitung**

Geeignet für viele Arten von Polsterungen und Bespannungen im Outdoorbereich, speziell für die Außenanwendung auf Booten und Yachten. Problemlose Verarbeitung nach den in der Polsterindustrie üblichen Verfahren (Nähen, Heften, Kleben, Nageln, HF-Schweißen). Keine eingefärbten Kleber oder Lösemittelkleber verwenden! Bei dunklen Farben kann ein leichter pull-up-Effekt auftreten.

**Sonstige Hinweise**

Zum Erhalt der Materialeigenschaften Ihres skai® Produktes ist eine regelmäßige Reinigung der Materialoberfläche erforderlich. Benutzen Sie hierzu eine warme, milde Seifenlauge und ein Mikrofasertuch oder eine weiche Handbürste. Bitte verwenden Sie keine chemischen Bleichen oder scheuernde Reinigungsmittel. Bitte beachten Sie, dass Anfärbungen des Materials durch Jeans oder andere Textilien von jeglicher Gewährleistung ausgenommen sind.

**Besondere Hinweise**

Unsere anwendungstechnischen Empfehlungen in Wort und Schrift, die wir aufgrund unserer Erfahrung entsprechend dem aktuellen Stand der Technik weitergeben, sind unverbindlich. Sie entbinden den Käufer nicht davon, die Eignung unsere Produkte für den vorgesehenen Verwendungszweck in eigener Verantwortung selbst zu prüfen. Dies gilt insbesondere für alle Komponenten, die zusammen mit unserem Produkt verarbeitet werden und deren Verträglichkeit im Verbund. Im Übrigen gelten unsere allgemeinen Geschäftsbedingungen. Hiermit verlieren alle früheren, anderslautenden Regelungen ihre Gültigkeit.

**Application / Processing**

Suitable for many kinds of upholstery and coverings for outdoor use, specifically for above-deck applications on boats and yachts. Can be readily processed by customary upholstery industry methods (sewing, stapling, bonding, nailing, HF welding). Do not use colored adhesives or solvent adhesives! A slight pull-up effect may occur with dark colours.

**Other instructions**

To maintain the material properties of your skai® product, it is necessary to regularly clean the material surface. Use a warm, mild soap solution and a microfiber cloth or a soft hand brush for this purpose. Please do not use chemical bleach or abrasive cleaning agents. Please note that staining of the material through jeans or other textiles is excluded from any warranty.

**Special notes**

Our spoken and written application engineering recommendations, which we pass on based on our experience and in accordance with the current state of the art, are non-binding. They do not absolve buyers of their own responsibility to check the suitability of our products for the intended purpose. This applies in particular to all components that are processed together with our product and their compatibility in combination with each other. Otherwise, our general terms and conditions are in effect. All earlier provisions to the contrary hereby become invalid.

**Aplicaciones / Manipulación**

Apto para numerosos tipos de tapizados y revestimientos exteriores, especialmente para lanchas y yates. Su confección sin problemas con los métodos habituales de la tapicería (costura, grapado, pegado, tachuelado, soldadura HF). ¡No utilizar adhesivos tintados ni a base de disolventes! En los colores oscuros puede aparecer un leve efecto pull up.

**Otros consejos**

Para conservar las propiedades del material de su producto de skai® es necesario limpiar regularmente la superficie del material. Utilice para ello lejía jabonosa suave y tibia con un paño de microfibra o un cepillo de mano suave. No utilice blanqueadores químicos ni productos de limpieza abrasivos. Tenga en cuenta que las manchas por decoloración en el material causadas por pantalones vaqueros u otros tejidos quedan excluidas de cualquier garantía.

**Advertencias especiales**

Las recomendaciones de aplicaciones técnicas que ofrecemos, ya sea de palabra o por escrito, en base a nuestra experiencia y conforme a los avances tecnológicos actuales, no son vinculantes. En ningún caso eximirán al comprador de comprobar por sí mismo y bajo su propia responsabilidad la idoneidad de nuestros productos para la finalidad de uso prevista. Esto se aplica especialmente para todos aquellos componentes que se utilicen junto con nuestro producto y su compatibilidad al combinarlos. En todo lo demás, se aplicarán nuestras condiciones generales, lo que supone la nulidad de cualquier otro acuerdo previo.



\*nach den gesetzlichen Bestimmungen prescribed by law de conformidad con las disposiciones legales



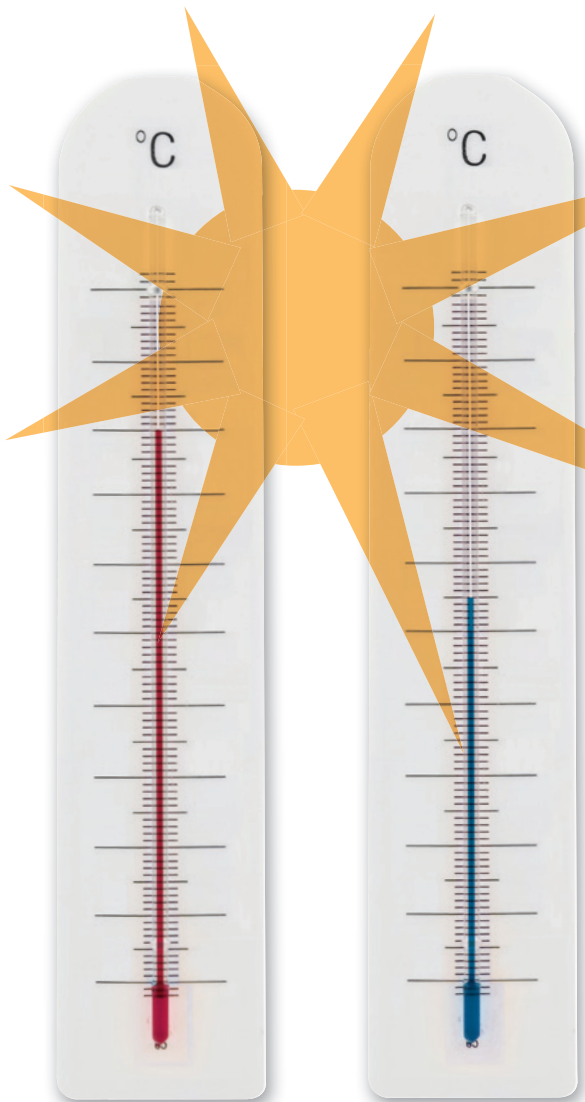

Standardmaterial/  
standard material/  
material convencional

skai® cool colors Venezia

### Bessere Remission - weniger Wärmeeintrag

Die extrem verbesserte Remission der Strahlung im nahen Infrarotbereich (780-1500 Nanometer) ist das Geheimnis der innovativen „cool colors“ Technologie. Die Wärmebildkamera macht den Effekt sichtbar: Im energiereichen Nahinfrarotbereich des Sonnenlichts bleiben „cool colors“ Synthetics deutlich kühler als vergleichbare Standard-Synthetics.

Wie stark sich Oberflächen aufheizen können, zeigen Tests mit einem Strahlungsthermometer. Temperaturen von bis zu 90 °C sind in direkter Sonne bei dunklen Farben keine Seltenheit. Der Direktvergleich beweist: Die Oberflächentemperatur von „cool colors“ Synthetics ist nach direkter Bestrahlung nachweisbar niedriger als die eines Standardmaterials.

### Better remission - less heat input

The greatly improved remission of the radiation in the near infrared range (780-1500 nanometer) is the secret of the innovative "cool colors" technology. The thermal imaging camera makes the effect visible: in the energy-rich near infrared range of sunlight, "cool colors" synthetics remain much cooler than comparable standard synthetics.

The degree to which surfaces can heat up is shown by tests with a pyrometer. Temperatures of up to 90 °C are not uncommon on dark colors in direct sunlight. Direct comparison proves: the surface temperature of "cool colors" synthetics is demonstrably lower than that of a standard material after exposure to direct sunlight.

### Mejor reflexión - Menor absorción de calor

La tremendamente mejorada reflexión de la radiación en el espectro infrarrojo cercano (780-1500 nanómetros) es el secreto de la innovadora tecnología «cool colors». La cámara termográfica lo revela de forma evidente: en el altamente energético espectro infrarrojo cercano de la luz solar, los materiales sintéticos con «cool colors» se mantienen más fríos que los materiales sintéticos convencionales comparables.

Un pirómetro muestra hasta qué punto pueden calentarse las superficies. Bajo la luz solar directa, no es raro que los colores oscuros alcancen temperaturas de hasta 90 °C. La comparación directa es la mejor demostración: la temperatura superficial de los materiales sintéticos dotados de «cool colors» es demostrablemente menor que la de un material convencional.

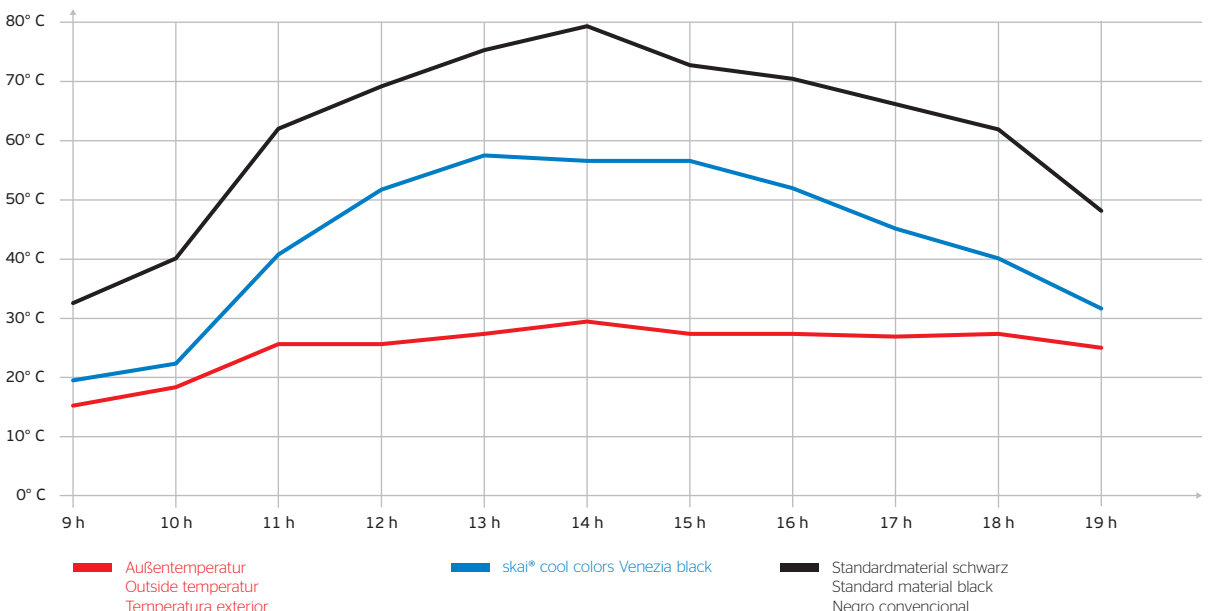

# skai® cool colors Collection

## Spezielle Farbpigmente wehren Hitze ab

Besonders für dunkle beschichtete Oberflächen war die Hitze in südlichen Ländern, aber z. B. auch in Skandinavien, bisher problematisch. Denn direkt der Sonne ausgesetzte Oberflächen können sich stark erhitzen.

Die optimale Lösung bieten hier die Farbpigmente der „cool colors“ Synthetics. Sie remittieren bis zu 80% der nahen Infrarotstrahlung des Sonnenlichts und reduzieren so die Erwärmung der Oberfläche um bis zu 25%. Das Ergebnis ist ein deutlich verbesserter Sitzkomfort und eine längere Lebensdauer der Materialien.

Die „cool colors“ Technologie bewährt sich bereits seit Jahren im Außeneinsatz bei Fenstern oder in Cabrios. Nun wird sie dem Outdoor-Möbelmarkt neue Impulse geben. Designer und Möbeldesigner können nun noch mehr als bisher auf Farbe setzen und ohne Probleme auf dunklere Töne zurückgreifen. Für grenzenlose Gestaltungsmöglichkeiten beim Möbeldesign.

## Special color pigments ward off heat

Heat in southern countries has been particularly problematic for dark surfaces, but also in places such as Scandinavia. Because surfaces that are exposed to direct sunlight can build up considerable heat.

Here, the color pigments of "cool colors" synthetics offer the optimal solution. They remit up to 80 % of the radiation in the near infrared range of sunlight and reduce the heating of the surface by up to 25 %. The result is clearly improved sitting comfort and increased useful life of the materials.

The "cool colors" technology has proven itself for years in exterior application on windows or in convertibles. Now, it will create new trends in the market for outdoor furniture. Designers and furniture creators can utilize colors more than ever before and safely make use of dark tones. For limitless design possibilities in furniture design.

## Pigmentos de color especiales que repelen el calor

Especialmente en el caso de las superficies acabadas en colores oscuros, el calor acumulado constituía un problema no solo en los países meridionales, sino también en Escandinavia, por ejemplo. No en vano, las superficies expuestas al sol pueden recalentarse considerablemente.

La solución óptima viene de la mano de los pigmentos de color de los materiales sintéticos «cool colors». Reflejan hasta un 80% de la radiación infrarroja de luz solar y reducen así el recalentamiento de la superficie en hasta un 25 %. El resultado es un confort de asiento claramente superior y una mayor vida útil de los materiales.

La tecnología «cool colors» se ha contrastado desde hace años en usos exteriores, por ejemplo, en ventanas o en vehículos descapotables. Ahora recibe un nuevo impulso en el mercado del mobiliario de exterior. Los diseñadores y creadores de muebles pueden emplear ahora el color con más libertad, recurriendo sin problema alguno a los tonos oscuros. Para unas posibilidades conceptuales sin límites en el diseño de muebles.

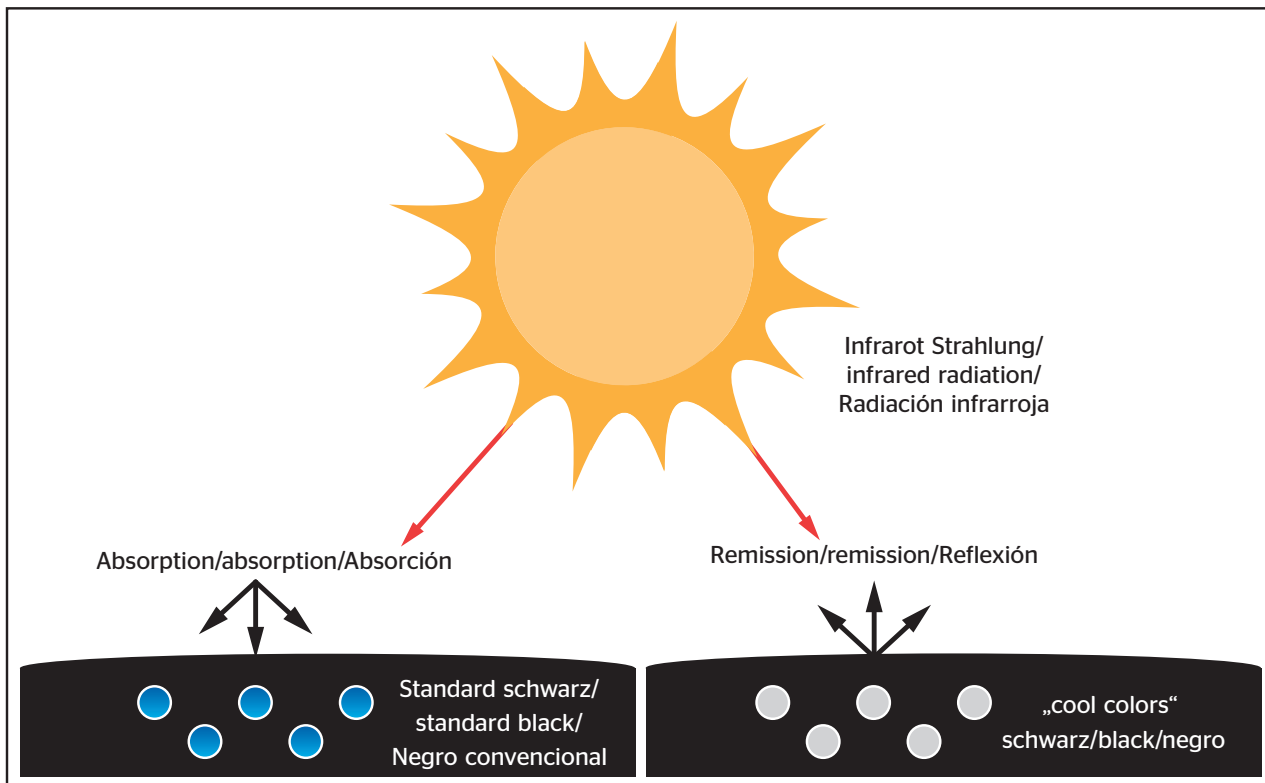

interzum award:  
intelligent  
material & design  
2013



German  
Design Award  
SPECIAL  
MENTION 2014



product  
design award  
2014



GOOD  
DESIGN





**Continental**  
The Future in Motion

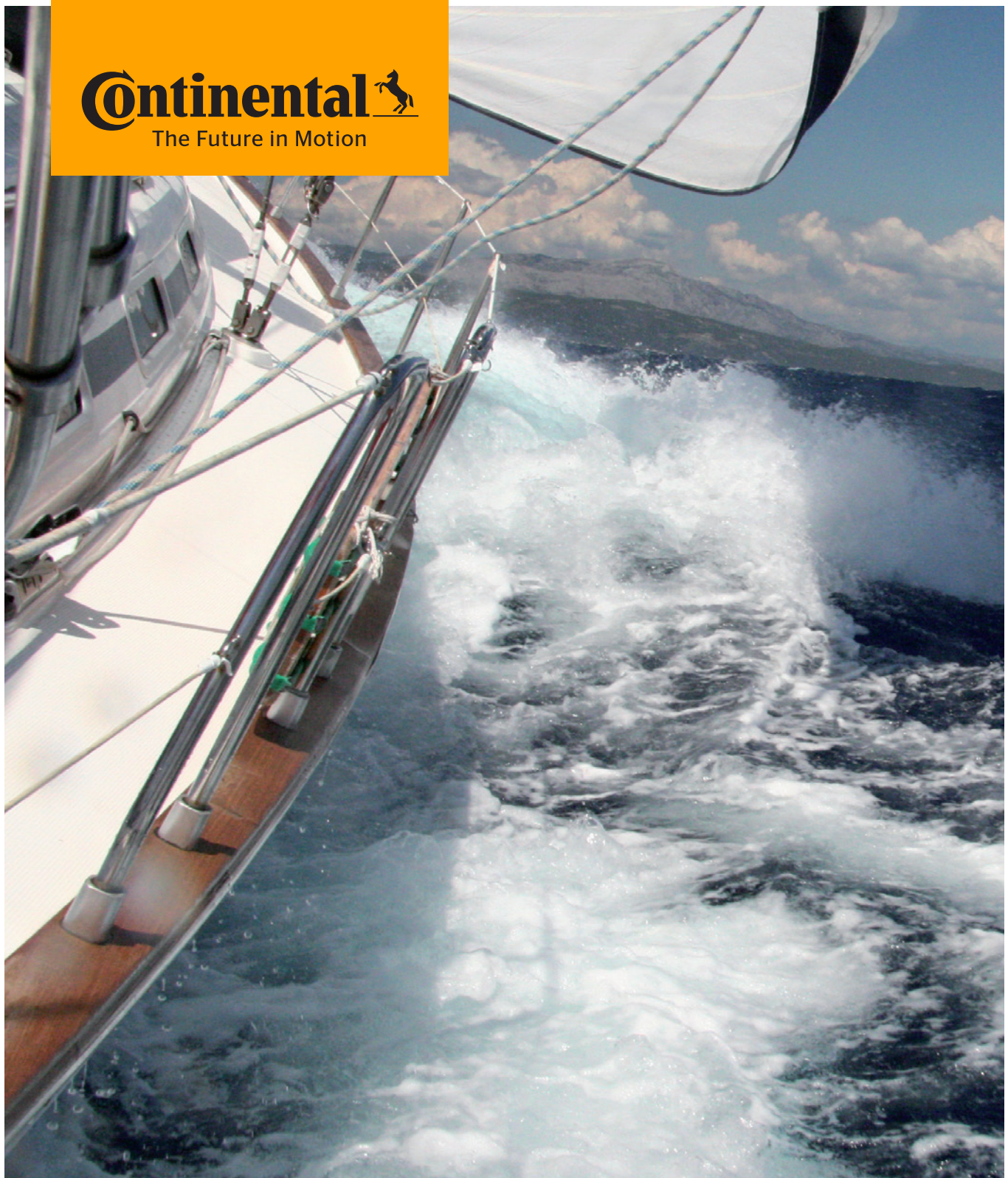

**skai® Neptun Collection**  
Outdoor



Hochwertiger Polsterbezugstoff  
speziell für anspruchsvolle Outdoor- und  
Objektanwendungen, besonders geeignet  
für Boote und Yachten.

High-quality upholstery material specifically  
for exclusive outdoor and contract furnishing  
applications; particularly suitable for boats  
and yachts.

Material de tapicería de alta calidad para  
mobiliario outdoor y contract, especialmente  
adecuado para los barcos y yates.

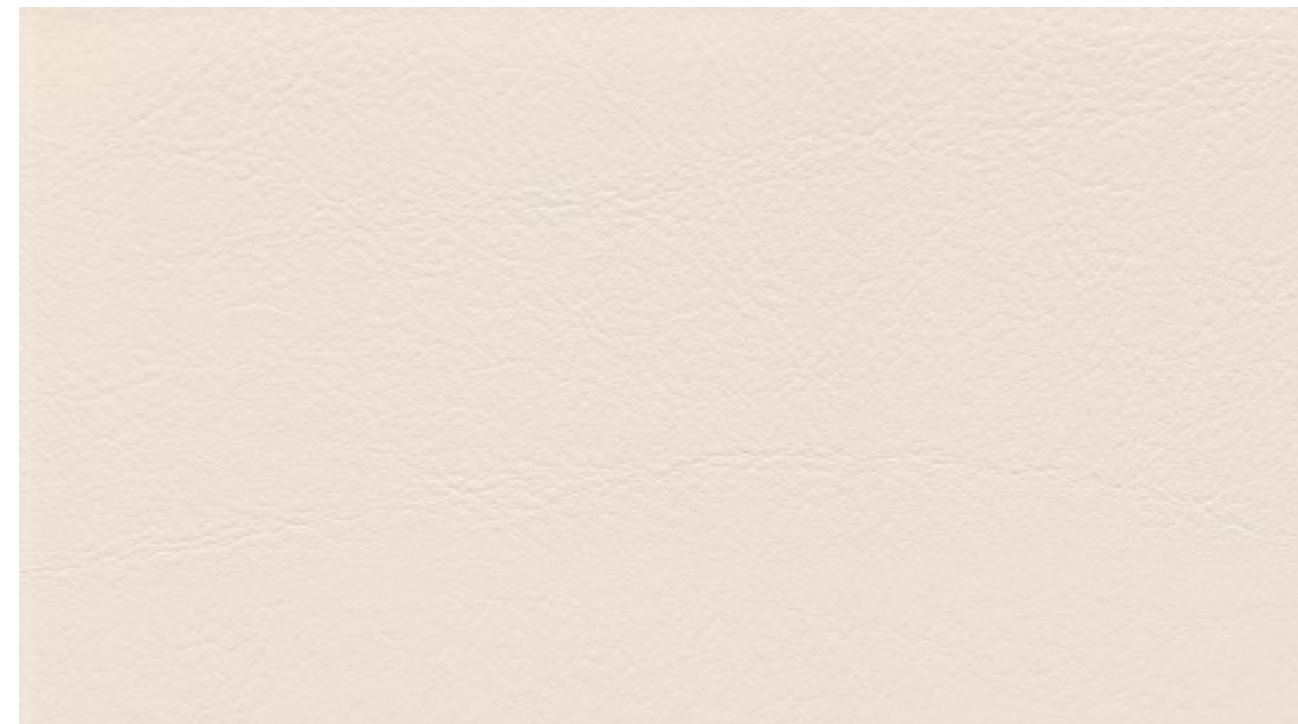

skai® Neptun Caleri creme F6494004

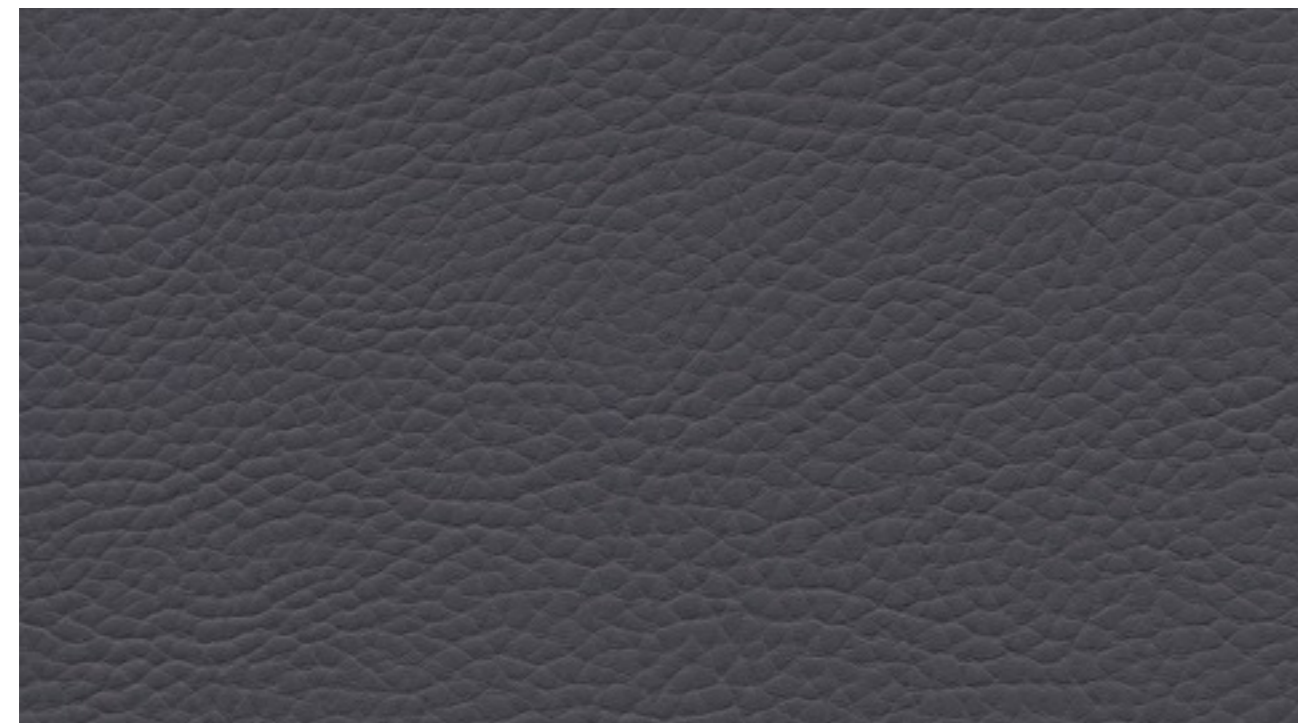

skai® Neptun Pescara shark-grey F6494095

## skai® Neptun Caleri



offwhite F6494002

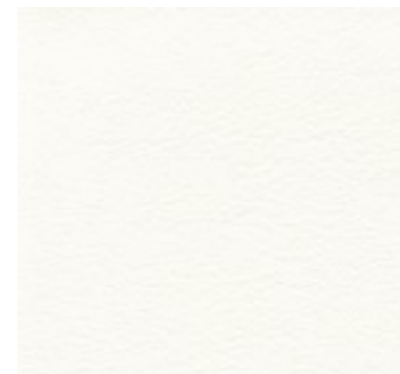

weiss F6494003

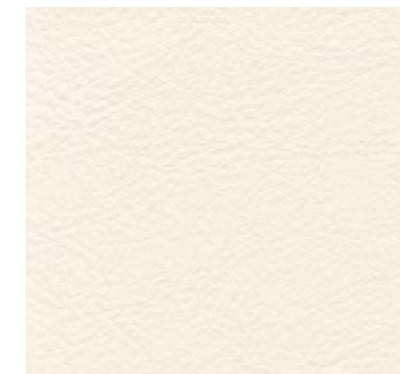

ivory F6494054

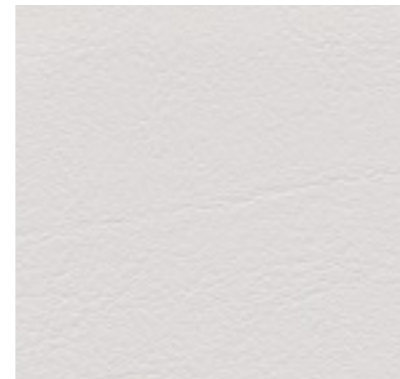

perle F6494005

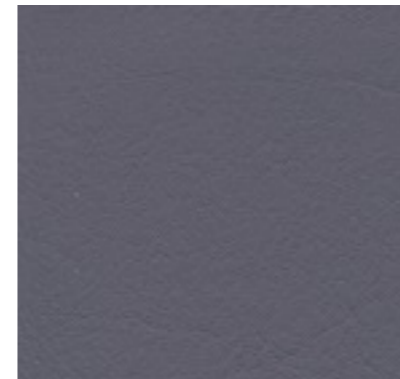

shark-grey F6494053



schwarz F6494013



kirsche F6494009

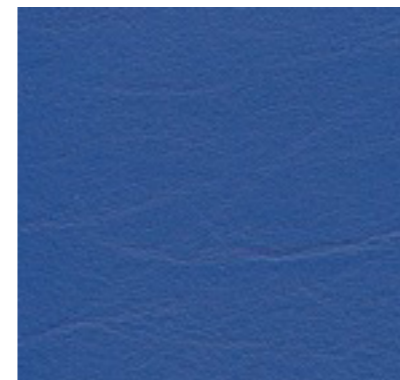

atoll F6494011



royal F6494012

## skai® Neptun Pescara

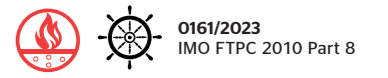

offwhite F6494017

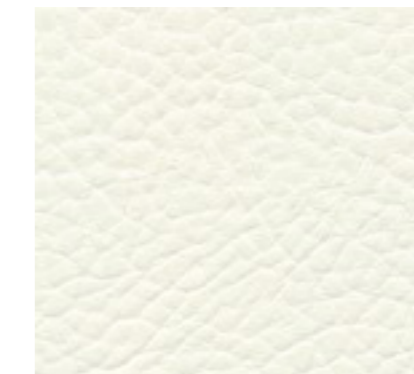

weiss F6494046

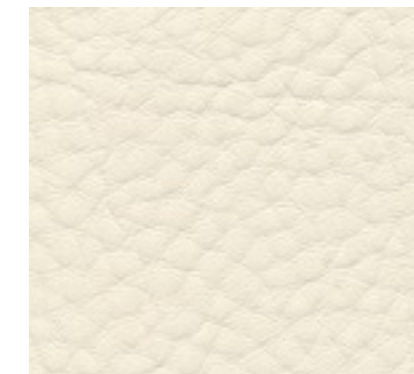

ivory F6494041

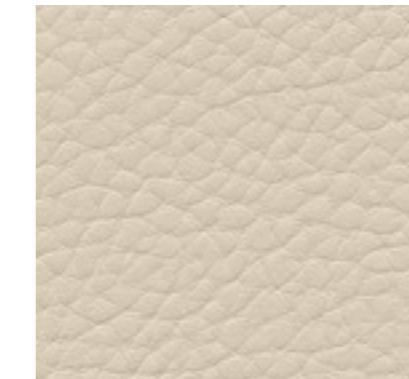

kiesel F6494042



birch F6494087

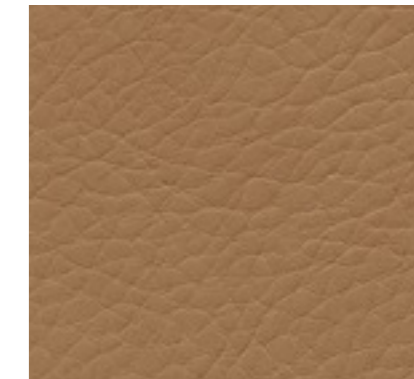

sattel F6494020



Public Area



Hospitality



Residential



Healthcare



Outdoor



Fitness



Marine Application

**Materialzusammensetzung:**

ca. 2 % Nano-Hightech-Compound  
ca. 88 % PVC-Compound  
ca. 10 % PES-Gewirke  
**Gewicht:** 860 +/- 60 g/m<sup>2</sup>  
**Dicke:** 1,15 +/- 0,2 mm  
**Rollenbreite:** 140 cm  
**Rollenlänge:** 30 m

**Material composition:**

approx. 2 % nano high-tech compound  
approx. 88 % PVC compound  
approx. 10 % knitted polyester  
**Weight:** 860 +/- 60 g/m<sup>2</sup>  
**Thickness:** 1,15 +/- 0,2 mm  
**Roll width:** 140 cm  
**Roll length:** 30 m

**Composición del material:**

aprox. 2 % compuesto Nano Hightech  
aprox. 88 % compuesto de PVC  
aprox. 10 % soporte de PES  
**Peso:** 860 +/- 60 g/m<sup>2</sup>  
**Espesor:** 1,15 +/- 0,2 mm  
**Ancho de rollo:** 140 cm  
**largo de rollo:** 30 m



langelig  
long-lasting  
larga vida útil



reißfest  
tear resistant  
resistente al desgarro



pflegeleicht  
easy to clean  
fácil mantenimiento



abriebfest  
abrasion resistant  
resistencia a la abrasión  
**DIN EN ISO 5470-2:**  
≥ 300 000 Martindale  
invers/inverse/inverso



UV-beständig  
UV resistant  
resistente a la radiación UV



bewitterungsstabil  
weather resistance  
resistencia ante los factores  
mediambientales



ölbeständig  
oil resistant  
resistente a los aceites



schwer entflammbar  
flame protection  
resistencia al fuego  
**DIN EN 1021-1+2,**  
**BS 5852 IS-0+1**



blut- und urinbeständig  
blood- and urine resistant  
resistente a la sangre  
y a la orina



salzwasserbeständig und  
chlorwasserbeständig  
salt water and chlorine  
water resistant  
resistente al agua salada y  
al agua clorada



desinfektionsmittelbeständig  
disinfectant resistant  
resistente a los desinfectantes



**0161/2023**  
IMO FTPC 2010 Part 8



vegan  
vegan  
vegano

**Anwendung / Verarbeitung**

Geeignet für viele Arten von Polsterungen und Bespannungen im Outdoorbereich, speziell für die Außenanwendung auf Booten und Yachten. Problemlose Verarbeitung nach den in der Polsterindustrie üblichen Verfahren (Nähen, Heften, Kleben, Nageln, HF-Schweißen). Keine eingefärbten Kleber oder Lösemittelkleber verwenden! Bei dunklen Farben kann ein leichter pull-up-Effekt auftreten.

**Sonstige Hinweise**

Zum Erhalt der Materialeigenschaften Ihres skai® Produktes ist eine regelmäßige Reinigung der Materialoberfläche erforderlich. Benutzen Sie hierzu den skai® Reiniger oder eine warme, milde Seifenlauge und ein Mikrofasertuch. Bitte verwenden Sie keine chemischen Bleichen oder scheuernde Reinigungsmittel. Bitte beachten Sie, dass Anfärbungen des Materials durch Jeans oder andere Textilien von jeglicher Gewährleistung ausgenommen sind.

**Besondere Hinweise**

Unsere anwendungstechnischen Empfehlungen in Wort und Schrift, die wir aufgrund unserer Erfahrung entsprechend dem aktuellen Stand der Technik weitergeben, sind unverbindlich. Sie entbinden den Käufer nicht davon, die Eignung unsere Produkte für den vorgesehenen Verwendungszweck in eigener Verantwortung selbst zu prüfen. Dies gilt insbesondere für alle Komponenten, die zusammen mit unserem Produkt verarbeitet werden und deren Verträglichkeit im Verbund. Im Übrigen gelten unsere allgemeinen Geschäftsbedingungen. Hiermit verlieren alle früheren, anderslautenden Regelungen ihre Gültigkeit.

**Application / Processing**

Suitable for many kinds of upholstery and coverings for outdoor use, specifically for above-deck applications on boats and yachts. Can be readily processed by customary upholstery industry methods (sewing, stapling, bonding, nailing, HF welding). Do not use colored adhesives or solvent adhesives. A slight pull-up effect may occur with dark colours.

**Other instructions**

To maintain the material properties of your skai® product, it is necessary to regularly clean the material surface. For cleaning, please use skai® cleaning agent or a warm, mild soapy water and a microfiber cloth. Please do not use chemical bleach or abrasive cleaning agents. Please note that staining of the material through jeans or other textiles is excluded from any warranty.

**Special notes**

Our spoken and written application engineering recommendations, which we pass on based on our experience and in accordance with the current state of the art, are non-binding. They do not absolve buyers of their own responsibility to check the suitability of our products for the intended purpose. This applies in particular to all components that are processed together with our product and their compatibility in combination with each other. Otherwise, our general terms and conditions are in effect. All earlier provisions to the contrary hereby become invalid.

**Aplicaciones / Manipulación**

Apto para numerosos tipos de tapizados para el exterior, especialmente para lanchas y yates. Confección sencilla con métodos habituales de la tapicería (costura, grapado, pegado, tachuelado, soldadura HF). ¡No utilizar adhesivos tintados ni a base de disolventes! En los colores oscuros puede aparecer un leve efecto pull up.

**Otros consejos**

Para conservar las propiedades del material de su producto de skai® es necesario limpiar regularmente la superficie del material. Para ello, utilice skai® limpiador o agua jabonosa caliente y suave y un paño de microfibra. No utilice blanqueadores químicos ni productos de limpieza abrasivos. Tenga en cuenta que las manchas por decoloración en el material causadas por pantalones vaqueros u otros tejidos quedan excluidas de cualquier garantía.

**Advertencias especiales**

Las recomendaciones de aplicaciones técnicas que ofrecemos, ya sea de palabra o por escrito, en base a nuestra experiencia y conforme a los avances tecnológicos actuales, no son vinculantes. En ningún caso eximirán al comprador de comprobar por sí mismo y bajo su propia responsabilidad la idoneidad de nuestros productos para la finalidad de uso prevista. Esto se aplica especialmente para todos aquellos componentes que se utilicen junto con nuestro producto y su compatibilidad al combinarlos. En todo lo demás, se aplicarán nuestras condiciones generales, lo que supone la nulidad de cualquier otro acuerdo previo.



\* nach den gesetzlichen Bestimmungen prescribed by law de conformidad con las disposiciones legales



### Damit liegen Sie im Freien richtig

Mit unserer Neptun Collection gehen Sie nicht baden, denn die Bezugsmaterialien vereinen optimal Design und Funktion. Ihre innovative Nanotechnologie macht sie besonders witterungsbeständig, schmutzunempfindlich und langlebig. Das wurde bereits mit dem Interzum-Award 2007 ausgezeichnet. Die Neptun Collection ist ideal geeignet für Outdoor-Polstermöbel im Garten, in der Gastronomie, auf Booten oder Yachten. Tauchen Sie ein in unsere Neptun Collection.

### Winzig klein - aber hoch wirksam

Unsere Neptun Collection schlägt mit Nanopartikeln Wellen. Das sind unvorstellbar winzige Strukturen (ein Nanometer passt in den Punkt am Ende dieses Satzes 100.000 Mal hinein) mit besonderen physikalischen Eigenschaften. Die „Zwerge“ (griech. nanos) machen unsere Bezugsmaterialien extrem resistent gegen Witterung. Ihre UV- und Salzwasser-Beständigkeit übertrifft die Werte vergleichbarer Synthetics um das Dreifache. So sind Outdoor-Polstermöbel optimal geschützt gegen Ausbleichen und ausgesprochen langlebig. Außerdem sind skai® Materialien mit sogenannter ‚nanoprofile‘ Protektion besonders schmutzunempfindlich. Selbst hartnäckige Rotwein-, Senf- oder Ketchup-Flecken lassen sich problemlos und ohne Rückstände entfernen. Kommen Sie mit uns an Bord und lassen Sie sich von der Welle der Möglichkeiten, die Ihnen die Neptun Linie bietet, tragen!

### Just right for the outdoor life

Steer clear of the rocks with our Neptun Collection upholstery materials, which offer the very best in function and design. Their innovative nanotechnology makes them exceptionally weatherproof, dirt resistant and durable - as already recognised by the Interzum Award 2007. The Neptun Collection is ideally suited for outdoor upholstered furniture in the garden, in cafés and restaurants, and for boats and yachts. Dive in to our Neptun Collection.

### Tiny - but highly effective

Our Neptun Collection is making waves with nanoparticles. These incredibly tiny structures (the full-stop at the end of this sentence measures 100,000 nanometres in size) have special physical properties. Taking their name from the Greek nanos (dwarf), they make our upholstery materials extremely resistant to the effects of the weather. Their UV and salt-water resistance exceeds the values of comparable synthetics by a factor of three, giving outdoor upholstered furniture optimum protection against fading, and achieving extreme durability. In addition, skai® materials with ‚nanoprofile‘ protection are particularly resistant to dirt. Even stubborn stains caused by red wine, mustard or ketchup can be removed easily and without trace. Come aboard and discover the sea of possibilities offered by the Neptun product line.

### La mejor forma de relajarse al aire libre

Con nuestra Neptun Collection, usted no se tira a la piscina: estos materiales de tapizado aúnan de forma óptima el diseño y la funcionalidad. Su innovadora nanotecnología los hace especialmente resistentes al clima, insensibles a la suciedad y duraderos, características que la hicieron merecedora del premio Interzum 2007. La Neptun Collection es ideal para los muebles tapizados para exterior, ya sea en el jardín, restauración, lanchas o yates. Sumérjase en nuestra Neptun Collection.

### Tamaño minúsculo, eficacia enorme

Nuestra Neptun Collection está en la onda gracias a sus nanopartículas. Se trata de partículas increíblemente pequeñas (un nanómetro cabría 100 000 veces en el punto que verá al final de esta frase) con propiedad físicas especiales. Estos «enanitos» (del griego nanos) hacen que nuestros materiales de tapizado sean tremendamente resistentes al clima. Su resistencia a la radiación UV y al agua salada triplica los niveles de los materiales sintéticos comparables. Así, sus muebles tapizados de exterior están protegidos de forma óptima contra el emblanquecimiento y son tremendamente duraderos. Además, los materiales skai® dotados de estos «nanoperfiles» son especialmente insensibles a la suciedad. Incluso las manchas persistentes de vino tinto, mostaza o ketchup se eliminan sin dificultad y sin dejar rastro. ¡Suba a bordo con nosotros y súmese a la onda de posibilidades que le ofrece la línea Neptun!





**Continental**   
The Future in Motion



**Individual**

Individual



**skai® Digital Print**  
Individual



## Kunstleder mit individuellem Digital-Druck

In Zusammenarbeit mit den skai® Experten kreieren Sie individuelle Digitaldruckdesigns und bedrucken damit eines unserer hochwertigen Kunstleder - passend zu Ihrem Projekt. Sie bringen das Wunschdesign mit und wählen die Materialqualität und Prägung sowie Farbe oder Rapport. Schnell und einfach individuelle Designs für Polsteranwendungen, die begeistern.

## Artificial leather with individual digital print

In collaboration with the skai® experts, you create individual digital print designs and use them to print one of our high-quality imitation leathers - to match your project. You bring the design you want and choose the material quality and embossing, as well as the color or repeat. Quickly and easily create individual designs for upholstery applications that inspire.

## Piel sintética con impresión digital personalizada

En colaboración con los expertos de skai®, usted crea diseños de impresión digital individuales y los utiliza para imprimir una de nuestras pieles de imitación de alta calidad, a juego con su proyecto. Usted trae el diseño que desea y elige la calidad del material y el gofrado, así como el color o la repetición. Cree rápida y fácilmente diseños individuales para aplicaciones de tapicería que inspiren.

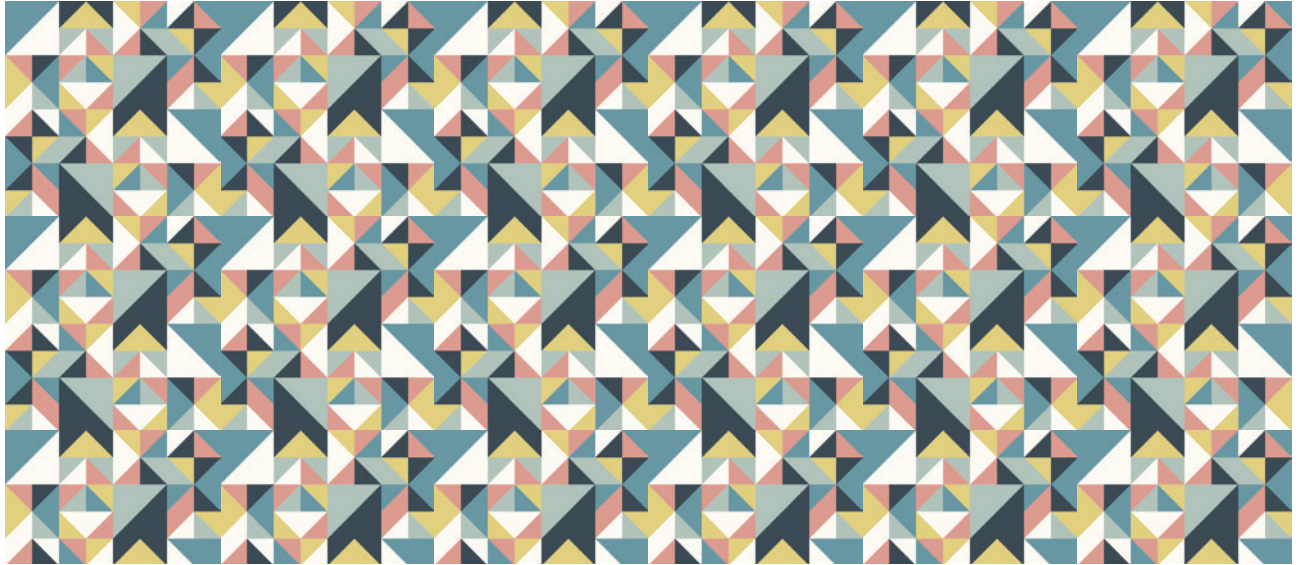

skai® Digital Print Amazing

## Pandoria base



0161/2022  
IMO FTPC 2010 Part 8

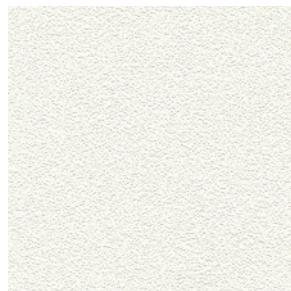

M272, H66414000

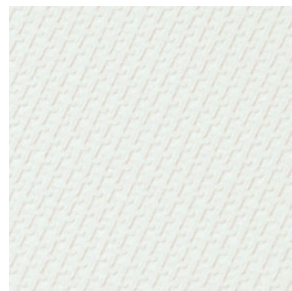

M358, H66414001

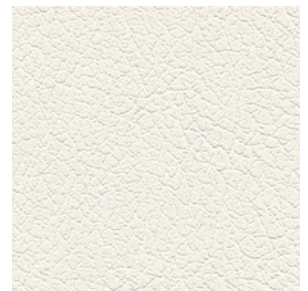

M403, H66414002

## Toledo EN base

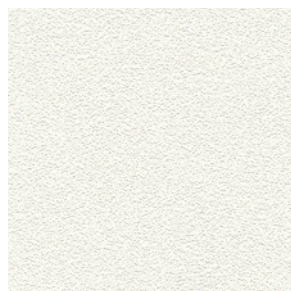

M272, H66474000

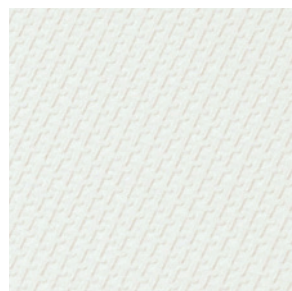

M358, H66474001

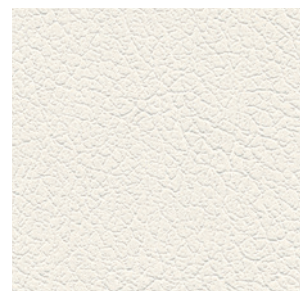

M403, H66474002





### Materialzusammensetzung

#### Pandoria:

ca. 12 % BW/PES-Gestrick  
ca. 88 % PVC-Compound

#### Toledo EN:

ca. 84 % PVC-Compound  
ca. 16 % PES-Gestrick

**Gewicht Pandoria:** 730 +/- 50 g/m<sup>2</sup>

**Gewicht Toledo EN:** 610 +/- 50 g/m<sup>2</sup>

**Pandoria, Toledo EN:**

**Dicke:** 1,2 +/- 0,2 mm

**Rollenbreite:** 137 cm

**Rollenlänge:** 30 m

### Material composition

#### Pandoria:

approx. 12 % CO/PES knitted fabric  
approx. 88 % PVC compound

#### Toledo EN:

approx. 84 % PVC-compound  
approx. 16 % PES-knitted fabric

**Weight Pandoria:** 730 +/- 50 g/m<sup>2</sup>

**Weight Toledo EN:** 610 +/- 50 g/m<sup>2</sup>

**Pandoria, Toledo EN:**

**Thickness:** 1.2 +/- 0.2 mm

**Roll width:** 137 cm

**Roll length:** 30m

### Composición del material

#### Pandoria:

aprox. 12 % soporte textil de punto  
de algodón/PES

aprox. 88 % compuesto de PVC

#### Toledo EN:

aprox. 84 % compuesto de PVC

aprox. 16 % soporte textil de punto de PES

**Peso Pandoria:** 730 +/- 50 g/m<sup>2</sup>

**Peso Toledo EN:** 610 +/- 50 g/

**Pandoria, Toledo EN:**

**Espesor:** 1,2 +/- 0,2 mm

**Ancho de rollo:** 137 cm

**largo de rollo:** 30 m



langlebig  
long-lasting  
larga vida útil



reißfest  
tear resistant  
resistente al desgarro



abriebfest  
abrasion resistant  
resistencia a la abrasión  
**DIN EN ISO 5470-2:**  
**Pandoria base:**  
**≥ 50 000 Martindale**  
**invers/inverse/inverso**  
**Toledo EN base:**  
**≥ 30 000 Martindale**  
**invers/inverse/inverso**



schwer entflammbar  
flame protection  
resistencia al fuego  
Pandoria:  
**NF M2, BS5852 IS-O+1,**  
**DIN 4102 (Part 1, B2),**  
**DIN EN 1021 1+2,**  
**MVSS 302, ASTM E 84**  
Toledo EN:  
**DIN EN 1021-1+2,**  
**BS 5852 IS-O+1, MVSS302,**  
**ASTM E 84, compliant with**  
**CAL AB 2988**



pflegeleicht  
easy to clean  
fácil mantenimiento



lichtecht  
lightfast  
resistente a la luz  
**DIN EN ISO 105-B02,**  
**Stufe 6 / level 6 / nivel 6**



vegan  
vegan  
vegano

### Anwendung / Verarbeitung

Geeignet für viele Arten von Bespannungen im trendorientierten und exklusiven Wohn- und Objektbereich. Besonders geeignet für den dekorativen Einsatz ohne starke mechanische Beanspruchung wie z.B. Bettkopfteile und Wandbespannungen. Problemlose Verarbeitung nach den üblichen Verfahren (Nähen, Heften, Kleben, Nageln). Keine eingefärbten Kleber oder Lösemittelkleber verwenden!

### Sonstige Hinweise

Zum Erhalt der Materialeigenschaften Ihres skai® Produktes ist eine regelmäßige Reinigung der Materialoberfläche erforderlich. Benutzen Sie hierzu den skai® Reiniger oder eine warme, milde Seifenlauge und ein Mikrofasertuch. Bitte verwenden Sie keine chemischen Bleichen oder scheuernde Reinigungsmittel. Bitte beachten Sie, dass Anfärbungen des Materials durch Jeans oder andere Textilien von jeglicher Gewährleistung ausgenommen sind.

### Besondere Hinweise

Unsere anwendungstechnischen Empfehlungen in Wort und Schrift, die wir aufgrund unserer Erfahrung entsprechend dem aktuellen Stand der Technik weitergeben, sind unverbindlich. Sie entbinden den Käufer nicht davon, die Eignung unsere Produkte für den vorgesehenen Verwendungszweck in eigener Verantwortung selbst zu prüfen. Dies gilt insbesondere für alle Komponenten, die zusammen mit unserem Produkt verarbeitet werden und deren Verträglichkeit im Verbund. Im Übrigen gelten unsere allgemeinen Geschäftsbedingungen. Hiermit verlieren alle früheren, anderslautenden Regelungen ihre Gültigkeit.

### Application / Processing

Suitable for many kinds of coverings in the modern and exclusive residential area and contract area. Especially suitable for decorative applications without much mechanical wear such as headboards and wall covering. Problem-free processing in the usual procedures (sewing, tacking, sticking, nailing). Do not use colored adhesives or solvent adhesives!

### Other instructions

To maintain the material properties of your skai® product, it is necessary to regularly clean the material surface. For cleaning, please use skai® cleaning agent or a warm, mild soapy water and a microfiber cloth. Please do not use chemical bleach or abrasive cleaning agents. Please note that staining of the material through jeans or other textiles is excluded from any warranty.

### Special notes

Our spoken and written application engineering recommendations, which we pass on based on our experience and in accordance with the current state of the art, are non-binding. They do not absolve buyers of their own responsibility to check the suitability of our products for the intended purpose. This applies in particular to all components that are processed together with our product and their compatibility in combination with each other. Otherwise, our general terms and conditions are in effect. All earlier provisions to the contrary hereby become invalid.

### Aplicaciones / Manipulación

Adecuado para numerosos tipos de tapizados y revestimientos en el sector de la tapicería, especialmente para su uso en el ámbito residencial y de diseño exclusivo y de tendencia. Especialmente diseñado para el empleo en espacios modernos tanto públicos como privados, en edificios públicos e instituciones. Aplicación sencilla por medio de procedimientos habituales (cosido, hilvanado, pegado, clavado). ¡No utilizar adhesivos tintados ni a base de disolventes!

### Otros consejos

Para conservar las propiedades del material de su producto de skai® es necesario limpiar regularmente la superficie del material. Para ello, utilice skai® limpiador o agua jabonosa caliente y suave y un paño de microfibra. No utilice blanqueadores químicos ni productos de limpieza abrasivos. Tenga en cuenta que las manchas por decoloración en el material causadas por pantalones vaqueros u otros tejidos quedan excluidas de cualquier garantía.

### Advertencias especiales

Las recomendaciones de aplicaciones técnicas que ofrecemos, ya sea de palabra o por escrito, en base a nuestra experiencia y conforme a los avances tecnológicos actuales, no son vinculantes. En ningún caso eximirán al comprador de comprobar por sí mismo y bajo su propia responsabilidad la idoneidad de nuestros productos para la finalidad de uso prevista. Esto se aplica especialmente para todos aquellos componentes que se utilicen junto con nuestro producto y su compatibilidad al combinarlos. En todo lo demás, se aplicarán nuestras condiciones generales, lo que supone la nulidad de cualquier otro acuerdo previo.



\* nach den gesetzlichen Bestimmungen prescribed by law de conformidad con las disposiciones legales



skai® Digital Print

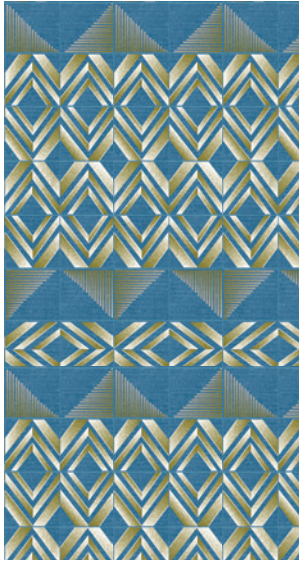

# skai® Digital Print

## Kundenspezifische Aufträge

Mit dem skai® Digital Print können einzigartige Designs für individuelle Projekte kreiert werden. Hochwertige Polsterbezugsstoffe der Qualität skai® Pandoria und skai® Toledo EN dienen als Basis, dazu kann eine der drei Prägungen gewählt werden: elegante Ledernarbung, klassische Textilstruktur, feine Mikroporenstruktur. Sie werden direkt digital bedruckt und anschließend mit einem Lack veredelt. Beide unterscheiden sich durch ihre FlammSchutzrüstung. Skai Pandoria weist den höheren FlammSchutz auf.

- › **Kostenloser Musterservice:**  
DIN A3 Muster zur Freigabe  
Maximal 3 Werkstage (ohne Lackierung)
- › **Lieferzeit:**  
4 - 6 Wochen
- › **Mindestbestellmenge:**  
50 lfm

Bei spezifischen Fragen beraten wir Sie gerne. Sprechen Sie uns einfach an.

## Customer-specific orders

Unique designs for individual projects can be created with the skai® Digital Print. High-quality upholstery fabrics of skai® Pandoria and skai® Toledo EN quality serve as the basis, and one of three embossings can be selected for them: elegant leather grain, classic textile structure, fine microporous structure. They are digitally printed directly and then finished with a varnish. Both differ in their flame retardant finish. Skai Pandoria has the higher flame retardancy.

- › **Free sample print:**  
A3 sample for approval  
Max. 3 working days (without lacquer)
- › **Delivery time:**  
4-6 weeks
- › **Minimum order quantity:**  
50 running meters

We will be happy to advise you if you have any specific questions. Just get in touch!

## Pedidos específicos de clientes

Con la impresión digital skai® se pueden crear diseños únicos para proyectos individuales. Los tejidos de tapicería de alta calidad skai® Pandoria y skai® Toledo EN sirven de base, y se puede elegir uno de los tres gofrados: elegante grano de cuero, estructura textil clásica, fina estructura microporosa. Se imprimen digitalmente de forma directa y luego se les da un acabado con laca. Ambos se diferencian por su acabado ignífugo. Skai Pandoria tiene la mayor resistencia al fuego.

- › **Muestra gratuita de impresión:**  
Muestra en formato DIN A3 para aprobación  
Máximo 3 días laborables (sin lacar)
- › **Plazo de entrega:**  
De 4 a 6 semanas
- › **Pedido mínimo:**  
50 metros lineales

Si tiene consultas específicas, no dude en ponerse en contacto con nosotros. Estaremos encantados de atenderle.





## Exotic Design

**Continental**   
The Future in Motion

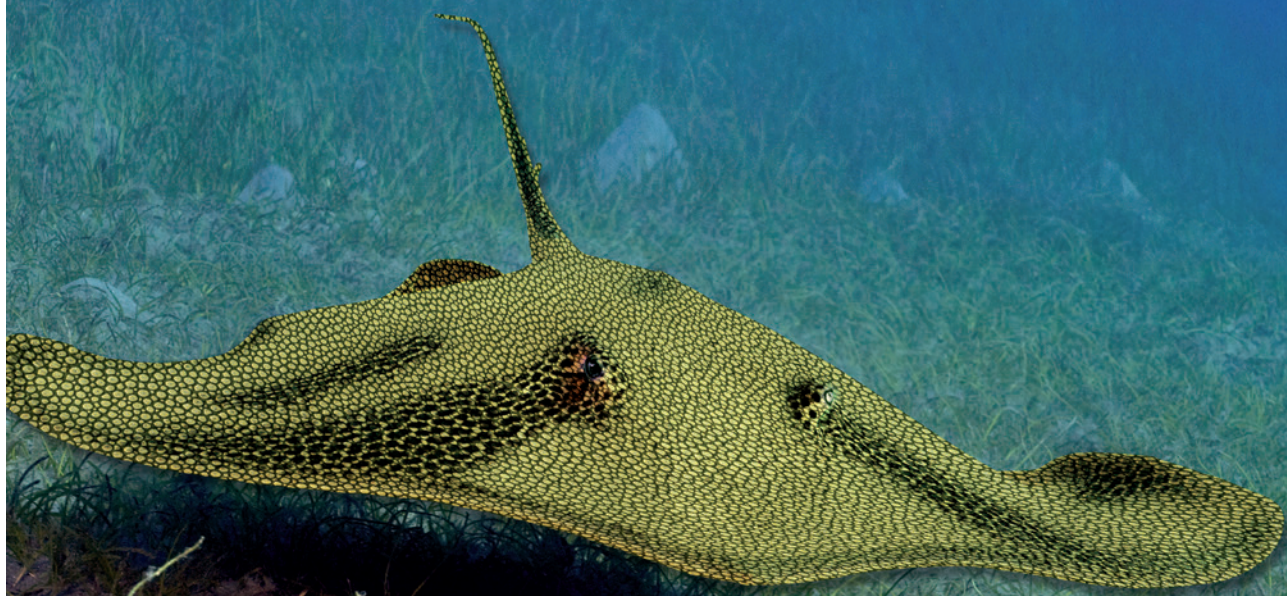

**skai<sup>®</sup> Soshagro EN**  
Exotic Design

phthalate-  
free  
from 2022

skai® Soshagro EN begeistert mit seiner originalgetreuen Manta-Ray-Optik. Seinen besonderen Reiz bezieht skai® Soshagro EN aus seinem interessanten Farbkontrast und dem feinen Matt-Glanz-Spiel der Täler und Kuppen.

skai® Soshagro EN fascinates with its true to original manta ray look. Its special allure results from its interesting color contrast and a fine play of matt and shiny areas due to grain valleys and lacquered peaks.

skai® Soshagro EN convence por su fiel imitación de la piel de la mantarraya. El especial atractivo de skai® Soshagro EN se debe a su interesante contraste de color y al delicado juego mate-brillo de sus valles y crestas.

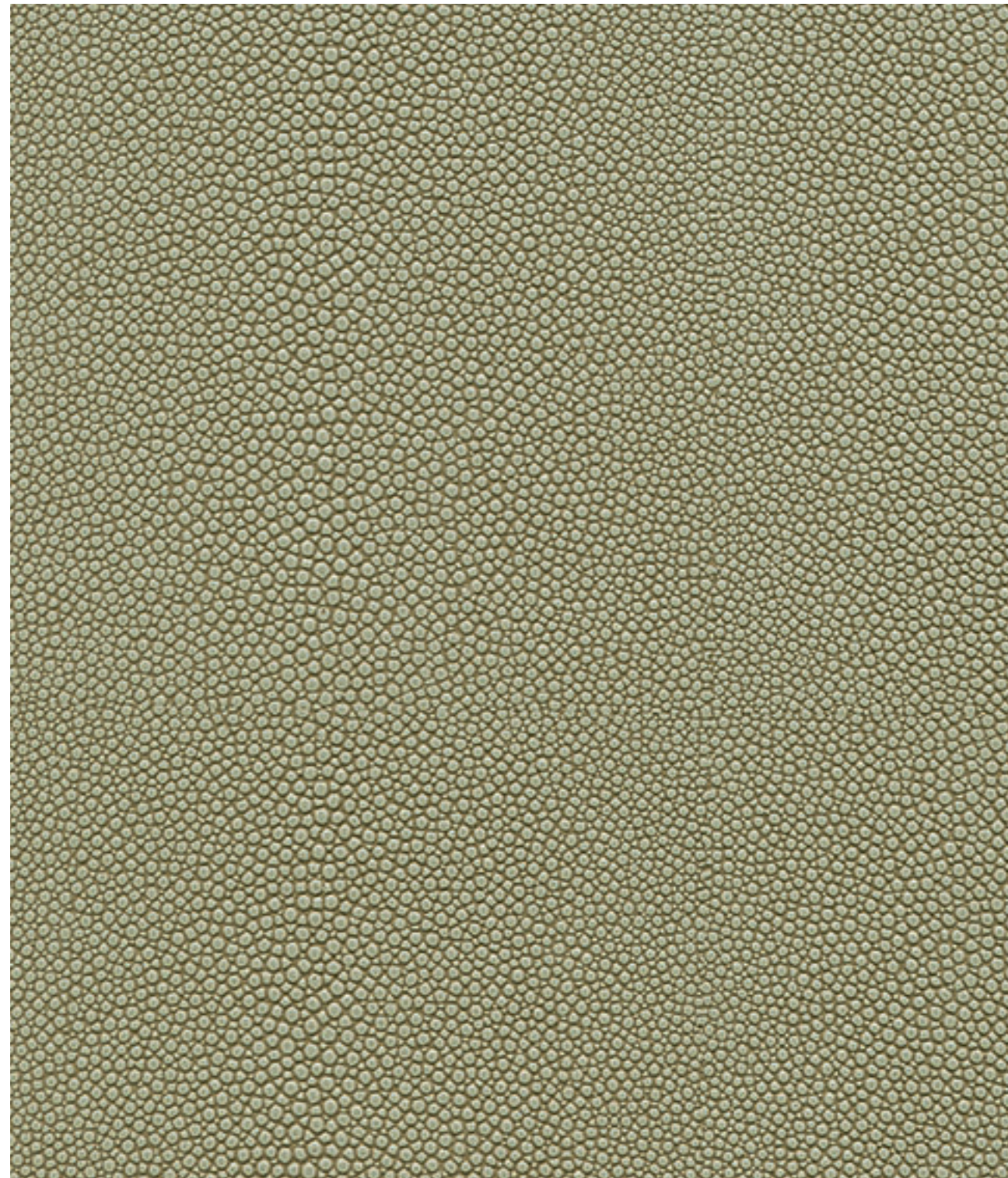

skai® Soshagro EN greige F5076114

**skai® Soshagro EN**



ivory F5076035

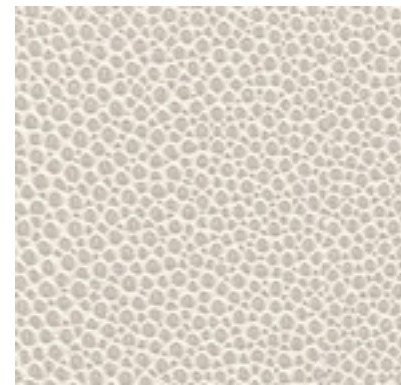

pearl F5076036

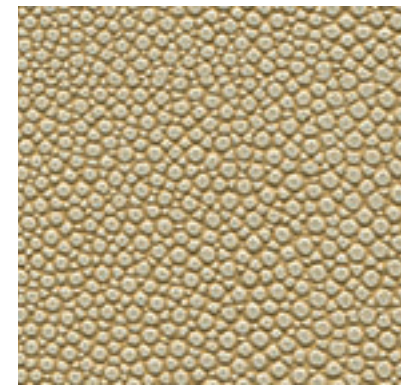

light sand F5076113

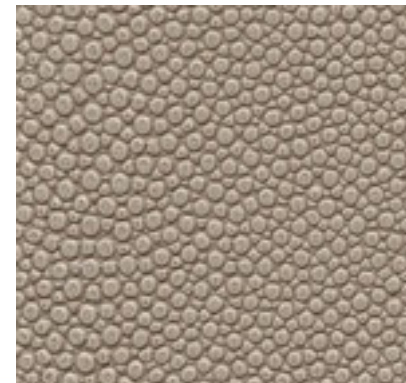

fog F5076038

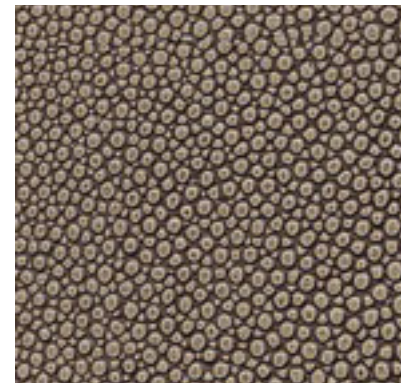

choco-cream F5076034

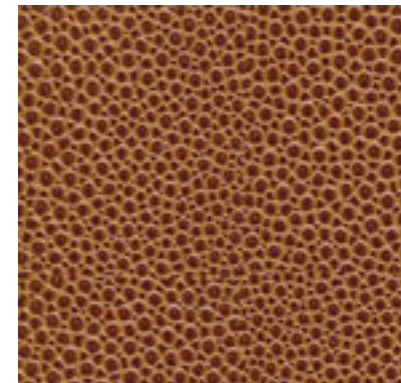

brown F5076039

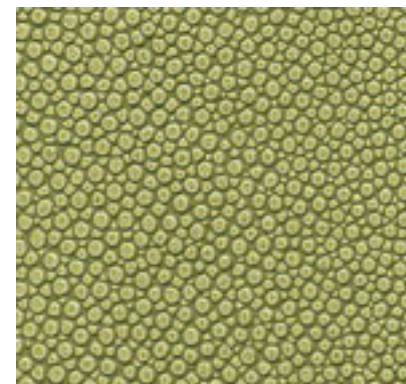

green F5076042

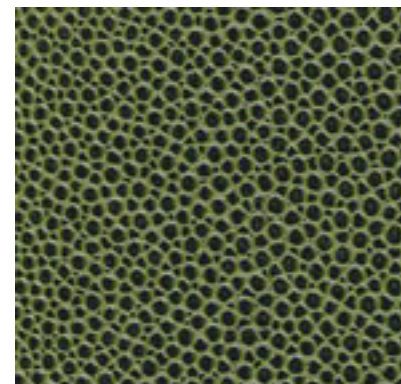

green-black F5076041

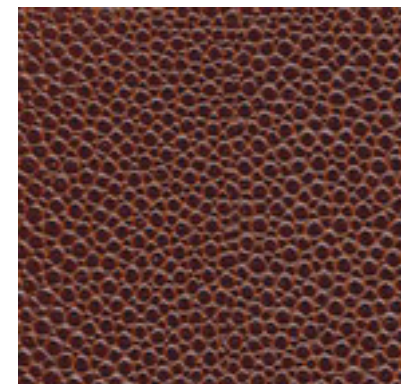

chestnut-mocca F5076040

**skai® Soshagro EN**

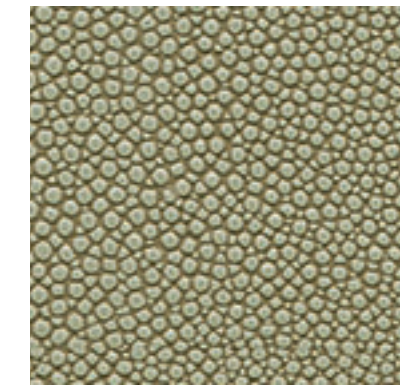

greige F5076114

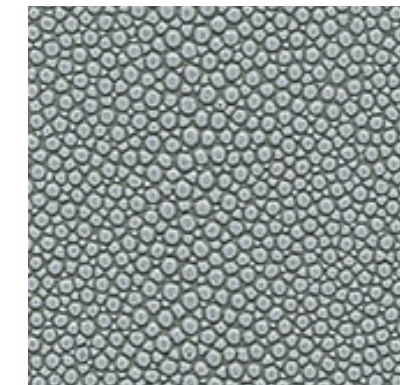

grey-green F5076115

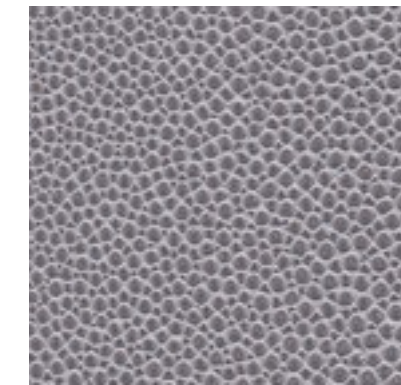

grey-anthracite F5076043

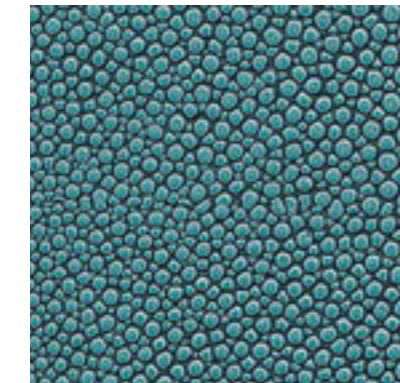

forest F5076045

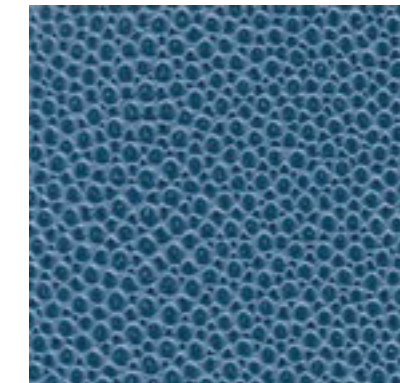

sky-ocean F5076044



black-metallic F5076046



Hospitality



Residential

**Materialzusammensetzung:**

ca. 1 % PU-finish  
ca. 74 % PVC-Compound  
ca. 25 % BW/PES-Gewebe  
**Gewicht:** 780 +/- 50 g/m<sup>2</sup>  
**Dicke:** 1,7 +/- 0,2 mm  
**Rollenbreite:** 150 cm  
**Rollenlänge:** 30 m

**Material composition:**

approx. 1 % PU-finish  
approx. 74 % PVC-compound  
approx. 25 % CO/PES-fabric  
**Weight:** 780 +/- 50 g/m<sup>2</sup>  
37.7 +/- 2.4 oz/yd  
**Thickness:** 1.7 +/- 0.2 mm  
**Roll width:** 150 cm / 59.1 in.  
**Roll length:** 30 m / 32.8 yd

**Composición del material:**

aprox. 1 % de acabado de PU  
aprox. 74 % compuesto de PVC  
aprox. 25 % soporte textil de algodón/PES  
**Peso:** 780 +/- 50 g/m<sup>2</sup>  
**Espesor:** 1,7 +/- 0,2 mm  
**Ancho de rollo:** 150 cm  
**Largo de rollo:** 30 m



**langlebig**  
long-lasting  
larga vida útil



**reißfest**  
tear resistant  
resistente al desgarro



**abriebfest**  
abrasion resistant  
resistencia a la abrasión  
**DIN EN ISO 5470-2:**  
**> 75 000 Martindale**  
**invers/inverse/inverso**  
**ASTM D4157 / CFFA-1A:**  
**≥ 50,000**  
**Abrieb Wyzenbeek**  
**double rubs Wyzenbeek**  
**doble frota Wyzenbeek**



**schwer entflammbar**  
flame protection  
resistencia al fuego  
**DIN EN 1021-1+2,**  
**BS 5852 IS-0+1, MVSS302,**  
**CA TB 117-2013, UFAC/**  
**NFPA260 Class 1**



**pflegeleicht**  
easy to clean  
fácil mantenimiento



**lichtecht**  
lightfast  
resistente a la luz



**phthalatfrei**  
phthalate-free  
no contiene ftalatos



**lösungsmittelfrei**  
solvent free  
exento de solvente



**0161/2023**  
IMO FTPC 2010 Part 8



**vegan**  
vegan  
vegano

**Anwendung / Verarbeitung**

Geeignet für viele Arten von Bepolsterungen und Bespannungen im trendorientierten und exklusiven Wohnbereich, in öffentlichen Gebäuden und Einrichtungen. Besonders geeignet für dekorative Anwendungen wie z.B. Bettkopfteile, Kissen und Wandbespannungen. Problemlose Verarbeitung nach den üblichen Verfahren (Nähen, Heften, Kleben, Nageln). Keine eingefärbten Kleber oder Lösemittelkleber verwenden!

**Sonstige Hinweise**

Zum Erhalt der Materialeigenschaften Ihres skai® Produktes ist eine regelmäßige Reinigung der Materialoberfläche erforderlich. Benutzen Sie hierzu eine warme, milde Seifenlauge und ein Mikrofasertuch oder eine weiche Handbürste. Bitte verwenden Sie keine chemischen Bleichen oder scheuernde Reinigungsmittel. Bitte beachten Sie, dass Anfärbungen des Materials durch Jeans oder andere Textilien von jeglicher Gewährleistung ausgenommen sind.

**Besondere Hinweise**

Unsere anwendungstechnischen Empfehlungen in Wort und Schrift, die wir aufgrund unserer Erfahrung entsprechend dem aktuellen Stand der Technik weitergeben, sind unverbindlich. Sie entbinden den Käufer nicht davon, die Eignung unserer Produkte für den vorgesehenen Verwendungszweck in eigener Verantwortung selbst zu prüfen. Dies gilt insbesondere für alle Komponenten, die zusammen mit unserem Produkt verarbeitet werden und deren Verträglichkeit im Verbund. Im Übrigen gelten unsere allgemeinen Geschäftsbedingungen. Hiermit verlieren alle früheren, anderslautenden Regelungen ihre Gültigkeit.

**Application / Processing**

Suitable for many kinds of upholsteries and coverings in the modern and exclusive residential and contract area. Especially suitable decorative applications such as headboards, cushions and wall coverings. Problem-free processing in the usual procedures (sewing, tacking, sticking, nailing). Do not use colored adhesives or solvent adhesives!

**Other instructions**

To maintain the material properties of your skai® product, it is necessary to regularly clean the material surface. Use a warm, mild soap solution and a microfiber cloth or a soft hand brush for this purpose. Please do not use chemical bleach or abrasive cleaning agents. Please note that staining of the material through jeans or other textiles is excluded from any warranty.

**Special notes**

Our spoken and written application engineering recommendations, which we pass on based on our experience and in accordance with the current state of the art, are non-binding. They do not absolve buyers of their own responsibility to check the suitability of our products for the intended purpose. This applies in particular to all components that are processed together with our product and their compatibility in combination with each other. Otherwise, our general terms and conditions are in effect. All earlier provisions to the contrary hereby become invalid.

**Aplicaciones / Manipulación**

Adecuado para numerosos tipos de tapizados y revestimientos, especialmente para su uso en el ámbito residencial exclusivo y de tendencia y en instalaciones y edificios públicos. Especialmente adecuado para aplicaciones decorativas, tales como cabeceros, cojines y revestimientos de pared. Aplicación sencilla por medio de procedimientos habituales (cosido, hilvanado, pegado, clavado). ¡No utilizar adhesivos tintados ni a base de disolventes!

**Otros consejos**

Para conservar las propiedades del material de su producto de skai® es necesario limpiar regularmente la superficie del material. Utilice para ello lejía jabonosa suave y tibia con un paño de microfibra o un cepillo de mano suave. No utilice blanqueadores químicos ni productos de limpieza abrasivos. Tenga en cuenta que las manchas por decoloración en el material causadas por pantalones vaqueros u otros tejidos quedan excluidas de cualquier garantía.

**Advertencias especiales**

Las recomendaciones de aplicaciones técnicas que ofrecemos, ya sea de palabra o por escrito, en base a nuestra experiencia y conforme a los avances tecnológicos actuales, no son vinculantes. En ningún caso eximirán al comprador de comprobar por sí mismo y bajo su propia responsabilidad la idoneidad de nuestros productos para la finalidad de uso prevista. Esto se aplica especialmente para todos aquellos componentes que se utilicen junto con nuestro producto y su compatibilidad al combinarlos. En todo lo demás, se aplicarán nuestras condiciones generales, lo que supone la nulidad de cualquier otro acuerdo previo.



\* nach den gesetzlichen Bestimmungen prescribed by law de conformidad con las disposiciones legales



**Continental**   
The Future in Motion



**skai<sup>®</sup> Sofelto EN**  
Exotic Design



Eine filigrane Fellstruktur, die einer afrikanischen Antilope nachempfunden ist. Die farbliche Akzentuierung der Narbtäler gepaart mit den leicht glänzenden Kuppen lassen einen edlen Changiereffekt entstehen. Die beeindruckende optische Anmutung eröffnet neue Gestaltungsmöglichkeiten beim Einsatz dieses Materials.

A delicate skin structure that adepts an African antelope's fur. The color accentuation of the grain valleys coupled with slightly shining tops create a sophisticated iridescent effect. Its stunning visual appeal opens up new design possibilities when using this material.

Una fina estructura de piel que emula la piel de un antilope africano. Los toques de color de sus valles, unido a sus crestas levemente brillantes, crean un noble efecto iridiscente. Su presencia visual impactante abre nuevas posibilidades de diseño en la aplicación de este material.



skai® Sofelto EN pebble F5076027



pearl F5076025



lightbeige F5076026



pebble F5076027



lightsilver F5076028



steel F5076029

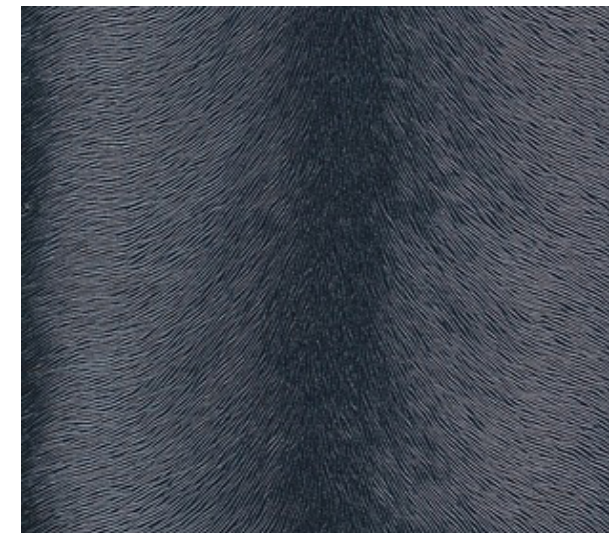

anthracite F5076030

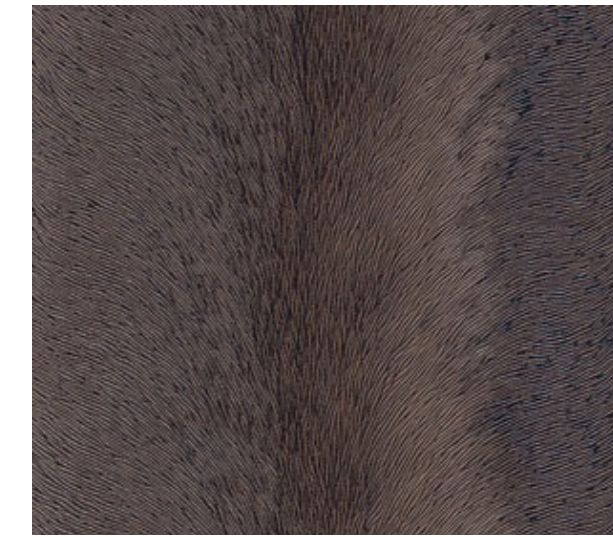

wood F5076031



gold F5076032



Public Area



Hospitality



Residential

**Materialzusammensetzung:**

ca. 2 % PU-Finish  
ca. 73 % PVC-Compound,  
ca. 25 % BW-Gewebe  
**Gewicht:** 810 +/- 50 g/m<sup>2</sup>  
**Dicke:** 1,6 +/- 0,2 mm  
**Rollenbreite:** 150 cm  
**Rollenlänge:** 30 m

**Material composition:**

approx. 2 % PU-Finish  
approx. 73 % PVC-compound  
approx. 25 % CO-fabric  
**Weight:** 810 +/- 50 g/m<sup>2</sup>  
39.2 +/- 2.4 oz/yd  
**Thickness:** 1.6 +/- 0.2 mm  
**Roll width:** 150 cm / 59.1 in.  
**Roll length:** 30 m / 32.8 yd

**Composición del material:**

aprox. 2 % de acabado de PU  
aprox. 73 % compuesto de PVC  
aprox. 25 % soporte de algodón  
**Peso:** 810 +/- 50 g/m<sup>2</sup>  
**Espesor:** 1,6 +/- 0,2 mm  
**Ancho de rollo:** 150 cm  
**Largo de rollo:** 30 m



langlebig  
long-lasting  
larga vida útil



reißfest  
tear resistant  
resistente al desgarro



abriebfest  
abrasion resistant  
resistencia a la abrasión  
**DIN EN ISO 5470-2:**  
≥ 100 000 Martindale  
**invers/inverse/inverso**  
**ASTM D4157 / CFFA-1A:**  
≥ 50 000  
**Abrieb Wyzenbeek**  
**double rubs Wyzenbeek**  
**doble frota Wyzenbeek**



schwer entflammbar  
flame protection  
resistencia al fuego  
**DIN EN 1021-1+2,**  
**BS 5852 IS-0+1, MVSS302**  
**CA TB 117-2013, UFAC/**  
**NFPA260 Class 1**



pflegeleicht  
easy to clean  
fácil mantenimiento



lichtecht  
lightfast  
resistente a la luz



vegan  
vegan  
vegano



lösungsmittelfrei  
solvent free  
exento de solvente



**0161/2023**  
IMO FTPC 2010 Part 8

**Anwendung / Verarbeitung**

Geeignet für viele Arten von Polsterungen und Spannungen in der Polsterindustrie. Besonders geeignet für den Einsatz im trendorientierten und exklusiven Wohnbereich, in öffentlichen Gebäuden und Einrichtungen. Ebenfalls geeignet für den Einsatz in der Taschen- und Lederwarenindustrie. Problemlose Verarbeitung nach den üblichen Verfahren (Nähen, Heften, Kleben, Nageln). Keine eingefärbten Kleber oder Lösemittelkleber verwenden!

**Sonstige Hinweise**

Zum Erhalt der Materialeigenschaften Ihres skai® Produktes ist eine regelmäßige Reinigung der Materialoberfläche erforderlich. Benutzen Sie hierzu eine warme, milde Seifenlauge und ein Mikrofaser Tuch oder eine weiche Handbürste. Bitte verwenden Sie keine chemischen Bleichen oder scheuernde Reinigungsmittel. Bitte beachten Sie, dass Anfärbungen des Materials durch Jeans oder andere Textilien von jeglicher Gewährleistung ausgenommen sind.

**Besondere Hinweise**

Unsere anwendungstechnischen Empfehlungen in Wort und Schrift, die wir aufgrund unserer Erfahrung entsprechend dem aktuellen Stand der Technik weitergeben, sind unverbindlich. Sie entbinden den Käufer nicht davon, die Eignung unsere Produkte für den vorgesehenen Verwendungszweck in eigener Verantwortung selbst zu prüfen. Dies gilt insbesondere für alle Komponenten, die zusammen mit unserem Produkt verarbeitet werden und deren Verträglichkeit im Verbund. Im Übrigen gelten unsere allgemeinen Geschäftsbedingungen. Hiermit verlieren alle früheren, anderslautenden Regelungen ihre Gültigkeit.

**Application / Processing**

Suitable for many kinds of upholsteries and coverings in the upholstery industry. Especially suitable for the use in the modern and exclusive residential and contract area, in public buildings and institutions. Problem-free processing in the usual procedures (sewing, tacking, sticking, nailing). Do not use colored adhesives or solvent adhesives!

**Other instructions**

To maintain the material properties of your skai® product, it is necessary to regularly clean the material surface. Use a warm, mild soap solution and a microfiber cloth or a soft hand brush for this purpose. Please do not use chemical bleach or abrasive cleaning agents. Please note that staining of the material through jeans or other textiles is excluded from any warranty.

**Special notes**

Our spoken and written application engineering recommendations, which we pass on based on our experience and in accordance with the current state of the art, are non-binding. They do not absolve buyers of their own responsibility to check the suitability of our products for the intended purpose. This applies in particular to all components that are processed together with our product and their compatibility in combination with each other. Otherwise, our general terms and conditions are in effect. All earlier provisions to the contrary hereby become invalid.

**Aplicaciones / Manipulación**

Adecuado para numerosos tipos de tapizados y revestimientos, especialmente para su uso en el ámbito residencial exclusivo y de tendencia y en instalaciones y edificios públicos. Igualmente adecuado para su uso en la fabricación de bolsos y maletas y en marroquinería. Aplicación sencilla por medio de procedimientos habituales (cosido, hilvanado, pegado, clavado). ¡No utilizar adhesivos tintados ni a base de disolventes!

**Otros consejos**

Para conservar las propiedades del material de su producto de skai® es necesario limpiar regularmente la superficie del material. Utilice para ello lejía jabonosa suave y tibia con un paño de microfibra o un cepillo de mano suave. No utilice blanqueadores químicos ni productos de limpieza abrasivos. Tenga en cuenta que las manchas por decoloración en el material causadas por pantalones vaqueros u otros tejidos quedan excluidas de cualquier garantía.

**Advertencias especiales**

Las recomendaciones de aplicaciones técnicas que ofrecemos, ya sea de palabra o por escrito, en base a nuestra experiencia y conforme a los avances tecnológicos actuales, no son vinculantes. En ningún caso eximirán al comprador de comprobar por sí mismo y bajo su propia responsabilidad la idoneidad de nuestros productos para la finalidad de uso prevista. Esto se aplica especialmente para todos aquellos componentes que se utilicen junto con nuestro producto y su compatibilidad al combinarlos. En todo lo demás, se aplicarán nuestras condiciones generales, lo que supone la nulidad de cualquier otro acuerdo previo.



\* nach den gesetzlichen Bestimmungen prescribed by law de conformidad con las disposiciones legales



## Interior Living

### Contact

Konrad Hornschuch AG  
Salinenstraße 1  
74679 Weißbach  
Germany  
Tel. +49 (0)7947 / 81-8714  
skai@continental.com  
www.skai.com



Benecke-Kaliko S.A.U  
Polígono Ind. Landaben C/A, n° 26  
31012 Pamplona (Navarra)  
Spain

O'Sullivan Films  
1944 Valley Avenue  
Winchester, Virginia 22601  
USA

Der Inhalt dieser Druckschrift ist unverbindlich und dient ausschließlich Informationszwecken. Die dargestellten gewerblichen Schutzrechte sind Eigentum der Continental AG und/oder ihrer Tochtergesellschaften. Copyright © 2023 Continental AG, Hannover. Alle Rechte vorbehalten. Weitere Informationen erhalten Sie unter [www.continental-industry.com/disc\\_de](http://www.continental-industry.com/disc_de)

The content of this print is non-binding and serves exclusively Information purposes. The industrial property rights shown are the property of Continental AG and / or its subsidiaries. Copyright © 2023 Continental AG, Hanover. All rights reserved. For further information, please visit [www.continental-industry.com/disc\\_en](http://www.continental-industry.com/disc_en)

El contenido de esta publicación no es vinculante y se utiliza exclusivamente. Con fines informativos. Las marcas comerciales mostrados son propiedad de Continental AG y / o sus filiales. Copyright © 2023 ContiTech AG, Hanover. Todos los derechos reservados. Más información está disponible en [www.continental-industry.com/disc\\_en](http://www.continental-industry.com/disc_en)